



2022





ANYWHERE ADVENTURE ABOUNDS

Since 1990, Sea to Summit has been your ally in every adventure—whether that’s on the deck of your sailboat or on a high-altitude expedition.

Designed to be the perfect balance of clever, packable and light, our award-winning products encourage self-reliance on any terrain.

Our love of the outdoors and our relentless pursuit of design perfection is what drives us. That’s why you can find our gear in the backpacks of explorers everywhere—from our home in Western Australia to the snowy mountains of Europe and the vast trails of North America.



INTRODUCING ALTO + TELOS

Ultralight backpacking tents with
more space, superior ventilation
and unmatched versatility

'By taking an intensive approach to the design of every feature, Sea to Summit made its new tents some of the most habitable available.'

– Gear Patrol

'The Telos TR2 is the sort of tent we've been dreaming about, which makes its arrival feel like an answered prayer.'

– Backpacker Magazine





**TENTS, TARPS
+ SHELTERS**

Tents NEW	6
Accessories	16
Tarps + shelters	24

CARE + PROTECTION

Towels UPDATED	206
Personal care UPDATED	211
Utility + convenience	221
Gaiters UPDATED	227
Insect protection clothing	234
Insect protection shelters	239
Pack + rain protection	243

SLEEP

Sleeping bags UPDATED	29
Quilts + Comforters NEW	62
Sleeping bag liners	72
Sleeping mats	80
Pillows	110
Hammocks	120

TRAVEL + COMMUTE

Every day carry	251
Bags + luggage	261
Organisation UPDATED	264
Travel accessories	273

CAMP KITCHEN

Camp Clean Up NEW	128
Dinnerware NEW	134
Cookware	154
Water transport	172

**STRAPS + TRANSPORT
ACCESSORIES**

Attachment accessories NEW	283
Straps	286
Field repair accessories	294
Roof accessories	297

STORAGE

Dry storage	178
Stuff + compression sacks	196

WATERSPORTS

Storage + transport	302
Paddle accessories	308
Personal accessories	315

GLOSSARY

	318
--	-----

TENTS, TARPS + SHELTERS



TENTS

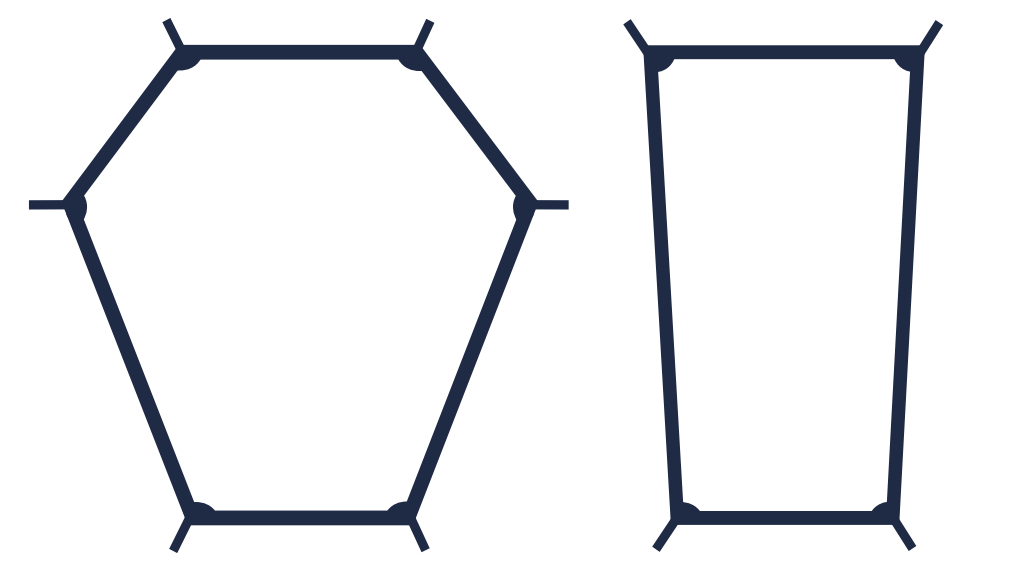

TENT, TARP + SHELTER
ACCESSORIES

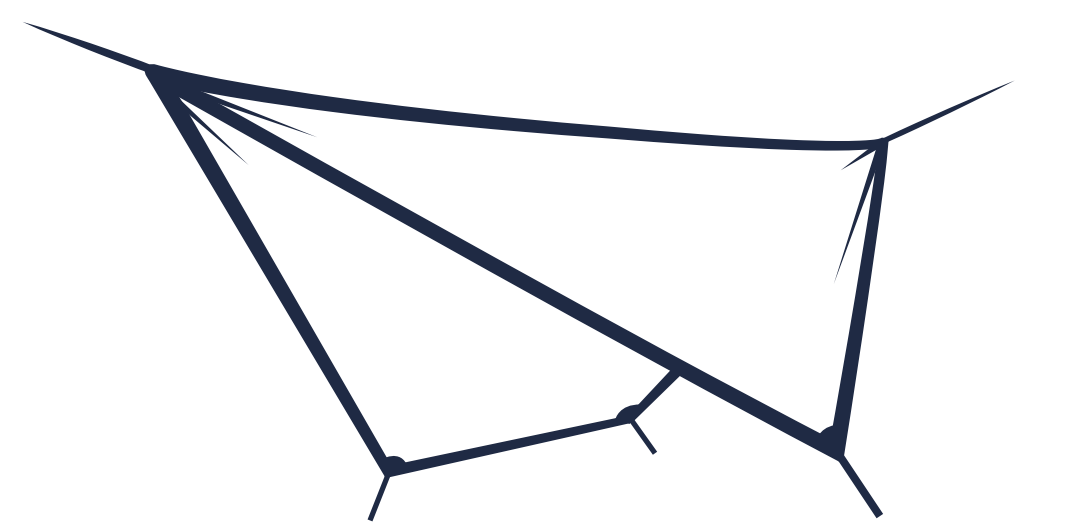

TARPS + SHELTERS



ALTO + TELOS TENTS

Award-winning, ultralight backpacking tents with more space, superior ventilation and unmatched versatility.

ALTO TR



TELOS TR

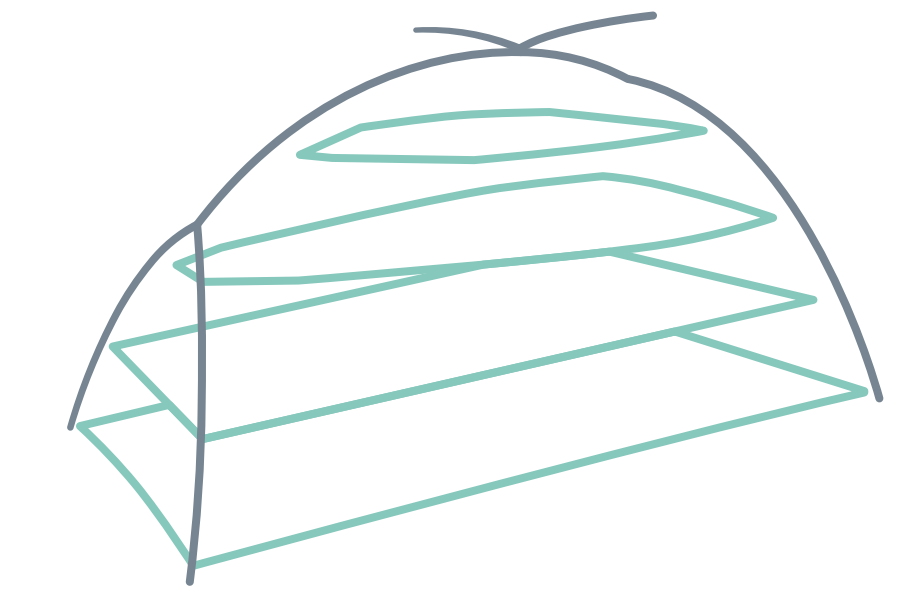

MORE SPACE

Tension Ridge architecture delivers a better space-to-weight ratio than any tent in its class.

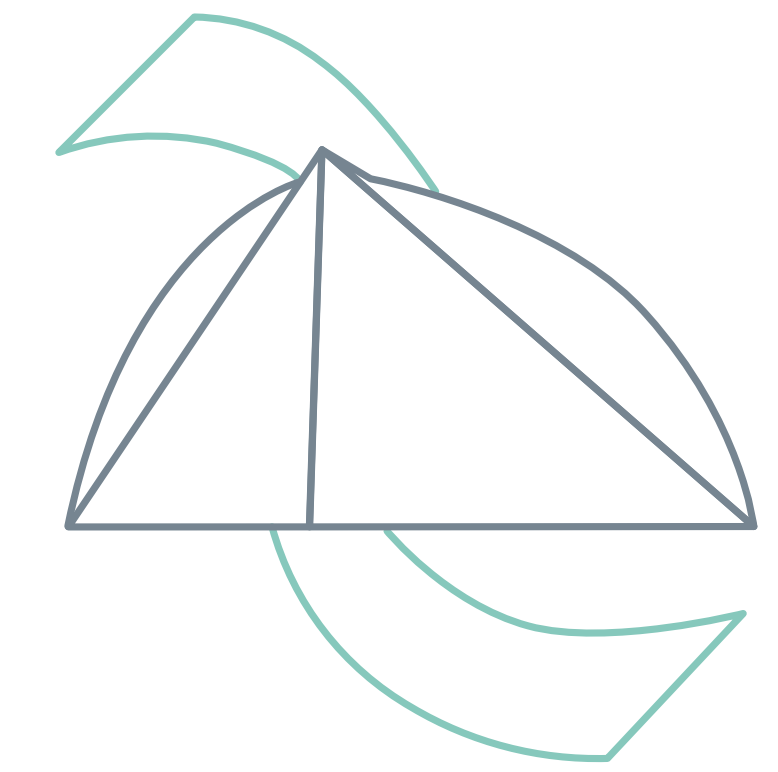

SUPERIOR VENTILATION

An advanced venting system improves airflow and reduces condensation.

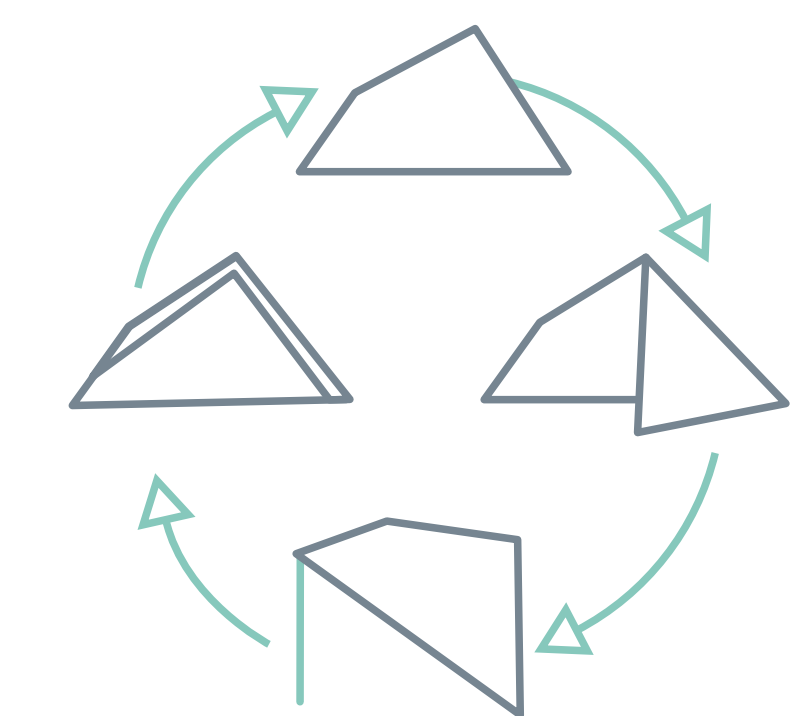

UNMATCHED VERSATILITY

Multiple configuration options means our tents adapt to the weather or your activity.

TENSION RIDGE
ARCHITECTURE BY JAKE LAH



REVOLUTIONARY TENSION RIDGE ARCHITECTURE

Where most tent poles angle down, the Tension Ridge angles up to achieve exceptional height and space.

TENSION RIDGE

ARCHITECTURE BY JAKE LAH

HIGH CEILINGS

Tall campers rejoice! Tension Ridge creates greater height across the whole tent—not just in one spot.

VERTICAL WALLS

No aggressively tapered walls here—just plenty of room for thicker modern sleeping mats.

APEX VENT

Unlike most, our Apex vent is at the highest point of our tents—the perfect position to expel moist warm air and minimise condensation.

TALL DOORS

Get in and out of your tent with ease and enjoy expansive views outside.





OUR TENSION RIDGE TENTS FEATURE:



INTRODUCING HANGOUT MODE

Convert your tent's fly into a semi-open shelter—perfect for group meals, socialising and staying undercover. Featured in all our Telos models, simply set-up with trekking poles or the Hangout Mode Pole Set (available separately).

QUICK-CONNECT TENT FEET

Machined aluminium clip attaches and tensions the fly with one-handed ease—much stronger than breakable plastic buckles.



FAIRSHARE STORAGE SYSTEM

Tent packs into three stuff sacks to split the load—after set-up, stuff sacks transform into gear storage pockets.

COLOUR-CODED DAC POLES

The gold standard in tent poles—our tents combine DAC Featherlite NFL, NSL and PRESSFIT sections.

GROUND CONTROL LIGHT TENT PEG

Lightweight, strong and versatile—our unique TriPoint tent pegs maximise grip in almost any ground.



LIGHTBAR

Add a headlamp and secure the tent pole storage sack to the apex of the tent for soft, even illumination.

MULTIPLE SET-UP MODES

Our tents easily adapt to suit your adventure, weather conditions and weight requirements.



CLASSIC MODE



FLY ONLY MODE



INNER ONLY MODE



DRY SET-UP



PARTIAL FLY MODE



EXPLORE THE RANGE

ALTO TR

Semi-freestanding ultralight backpacking tents.



TELOS TR

Award-winning freestanding ultralight backpacking tents.





ALTO TR

TELOS TR

	ONE PERSON		TWO PERSON		TWO PERSON			THREE PERSON		
	ALTO TR1	ALTO TR1 PLUS	ALTO TR2	ALTO TR2 PLUS	TELOS TR2	TELOS TR2 BIKEPACK <small>NEW</small>	TELOS TR2 PLUS	TELOS TR3	TELOS TR3 PLUS	
INNER CONSTRUCTION										INNER CONSTRUCTION
SEASONS	3 Season	3+ Season	3 Season	3+ Season	3 Season	3 Season	3+ Season	3 Season	3+ Season	SEASONS
DOORS	1	1	2	2	2	2	2	2	2	DOORS
VESTIBULES	1	1	2	2	2	2	2	2	2	VESTIBULES
ARCHITECTURE	Semi-Freestanding		Semi-Freestanding		Freestanding			Freestanding		ARCHITECTURE
TENSION RIDGE (TR)										TENSION RIDGE (TR)
APEX VENT										APEX VENT
LIGHTBAR										LIGHTBAR
HANGOUT MODE	-	-	-	-						HANGOUT MODE
MINIMUM TRAIL WEIGHT <small>Fly + inner + poles only</small>	938g 33.1 oz	1056g 37.2 oz	1156g 40.8 oz	1247g 44.9 oz	1482g 52.3 oz	1507g 53.2oz	1531g 54 oz	1921g 67.8 oz	2127g 71.7 oz	MINIMUM TRAIL WEIGHT <small>Fly + inner + poles only</small>
PACKED WEIGHT <small>Above + pegs, stuff sack, guys</small>	1110g 42.9 oz	1228g 43.3 oz	1340g 47.3 oz	1458g 51.4 oz	1657g 58.4 oz	1914g 67.5 oz	1706g 60.2 oz	2118g 74.7 oz	2229g 78.6 oz	PACKED WEIGHT <small>Above + pegs, stuff sack, guys</small>
FLOOR DIMENSIONS <small>(head-foot W) x L</small>	(107-60) x 215cm (42-24) x 84.5 in		(134-97) x 215cm (53-38) x 84.5 in		(134-109) x 215cm (53-43) x 84.5 in			(181-147) x 230cm (71-58) x 90.5 in		FLOOR DIMENSIONS <small>(head-foot W) x L</small>
DOOR HEIGHT	108cm 42.5 in		108cm 42.5 in		110cm 43.3 in			133cm 52.4in		DOOR HEIGHT
RIDGE HEIGHT	100cm 39.4 in		100cm 39.4 in		100cm 39.4 in			123cm 48.4in		RIDGE HEIGHT
PEAK HEIGHT	105cm 41.3 in		105cm 41.3 in		105cm 41.3 in			128cm 50.4 in		PEAK HEIGHT
FLOOR AREA	1.8m ² 19.5 ft ²		2.5m ² 27 ft ²		2.62m ² 28 ft ²			3.69m ² 39.5 ft ²		FLOOR AREA
VESTIBULE AREA	0.7m ² 7.5 ft ²		1.7m ² 18.5 ft ²		1.8m ² 19.5 ft ²			2m ² 21.5 ft ²		VESTIBULE AREA
MAT COMPATIBILITY <small>Sea to Summit</small>	1 Large Tapered		1 Large + 1 Regular Tapered		2 Large Tapered			2 Large Rectangular OR 3 Regular Tapered OR 2 Regular + 1 Large Tapered (inverted)		MAT COMPATIBILITY <small>Sea to Summit</small>
FLY FABRIC	15D Sil-PeU	15D Sil-PeU	15D Sil-PeU	15D Sil-PeU	15D Sil-PeU	15D Sil-PeU	15D Sil-PeU	15D Sil-PeU	15D Sil-PeU	FLY FABRIC
FLY WATERHEAD	1200mm	1200mm	1200mm	1200mm	1200mm	1200mm	1200mm	1200mm	1200mm	FLY WATERHEAD
FLOOR FABRIC	15D Sil-PeU	20D Sil-PeU	15D Sil-PeU	20D Sil-PeU	20D Sil-PeU	20D Sil-PeU	30D Sil-PeU	20D Sil-PeU	30D Sil-PeU	FLOOR FABRIC
FLOOR WATERHEAD	1200mm	2500mm	1200mm	2500mm	2500mm	2500mm	8000mm	2500mm	8000mm	FLOOR WATERHEAD
COLOUR										COLOUR



TELOS TR2 BIKEPACK



NEW
LIMITED IN '22

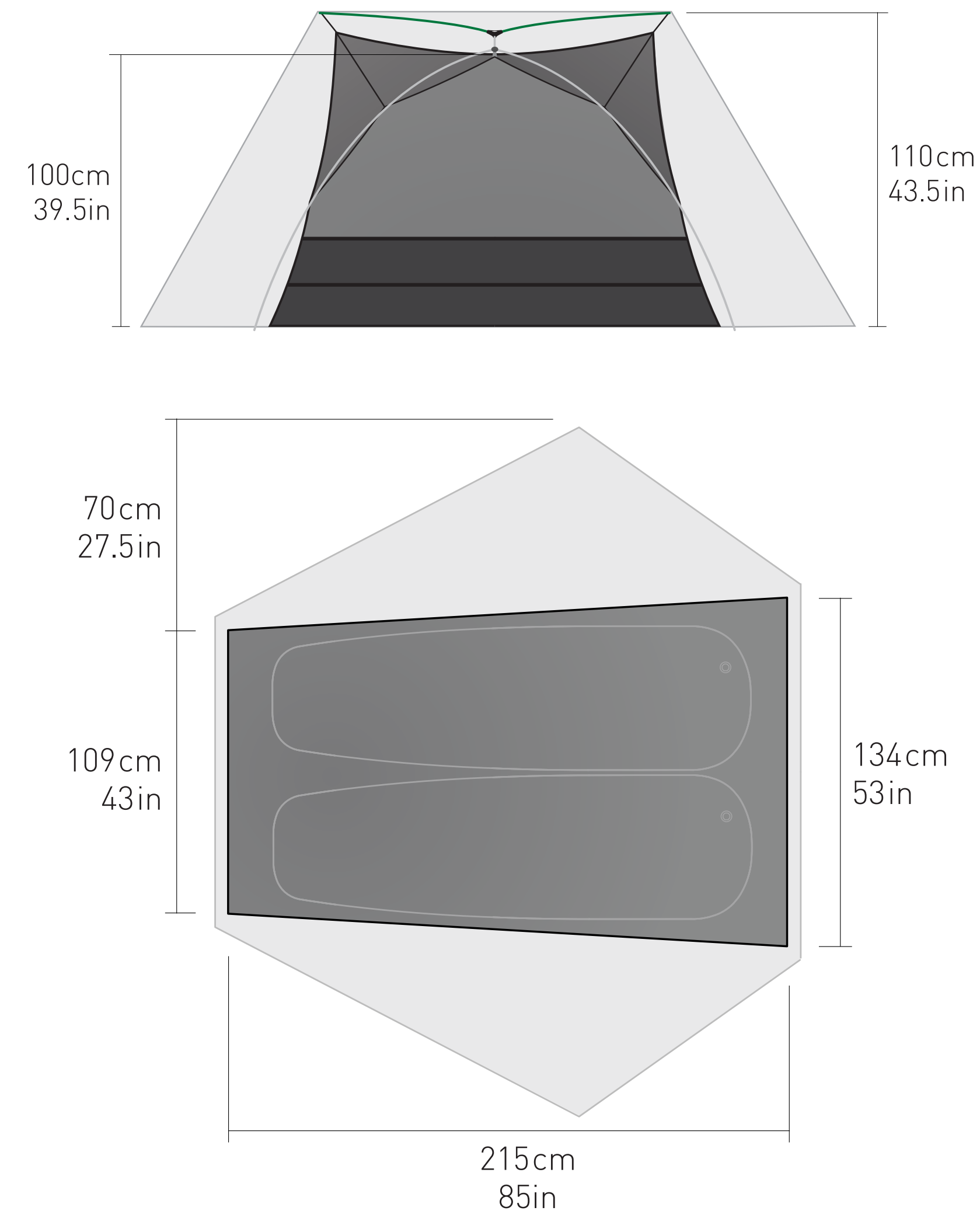

Ultra-lightweight 15D polyester high-airflow mesh inner for maximum ventilation and no-see-um insect protection.



Our modular storage system allows you to split the load between your fellow campers, or pack each component separately for even weight distribution and to suit space limitation of your bike.



Shorter pole sections to better suit bike packing needs.

FEATURES HANGOUT MODE





TELOS TR

TR2 TR2 PLUS TR3 TR3 PLUS

Featuring Hangout Mode, our award-winning freestanding Telos tents deliver the ultimate ultralight camp experience.

Available in two-person and three-person configurations.



*Telos TR2 pictured

FEATURES HANGOUT MODE



TELOS TR2 TR3

Ultra-lightweight 15D polyester high-airflow mesh inner for maximum ventilation and no-see-um insect protection.



TELOS TR2 PLUS TR3 PLUS

Breathable 20D Nylon fabric canopy with a 30D Sil-PeU coated, seam-taped 8000mm waterhead floor for dependable performance in cold and wet conditions.

TELOS TR2 TR2 PLUS

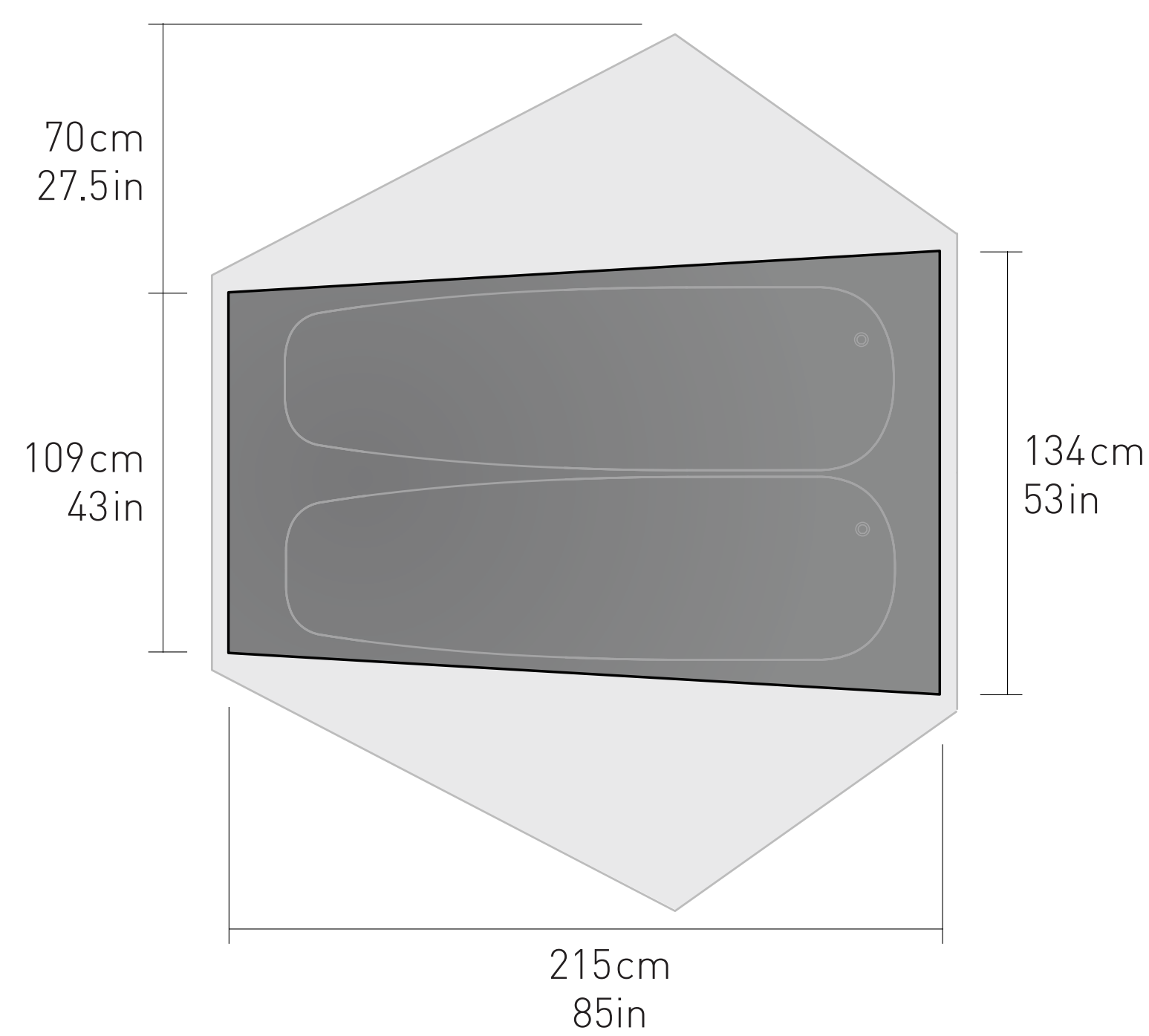
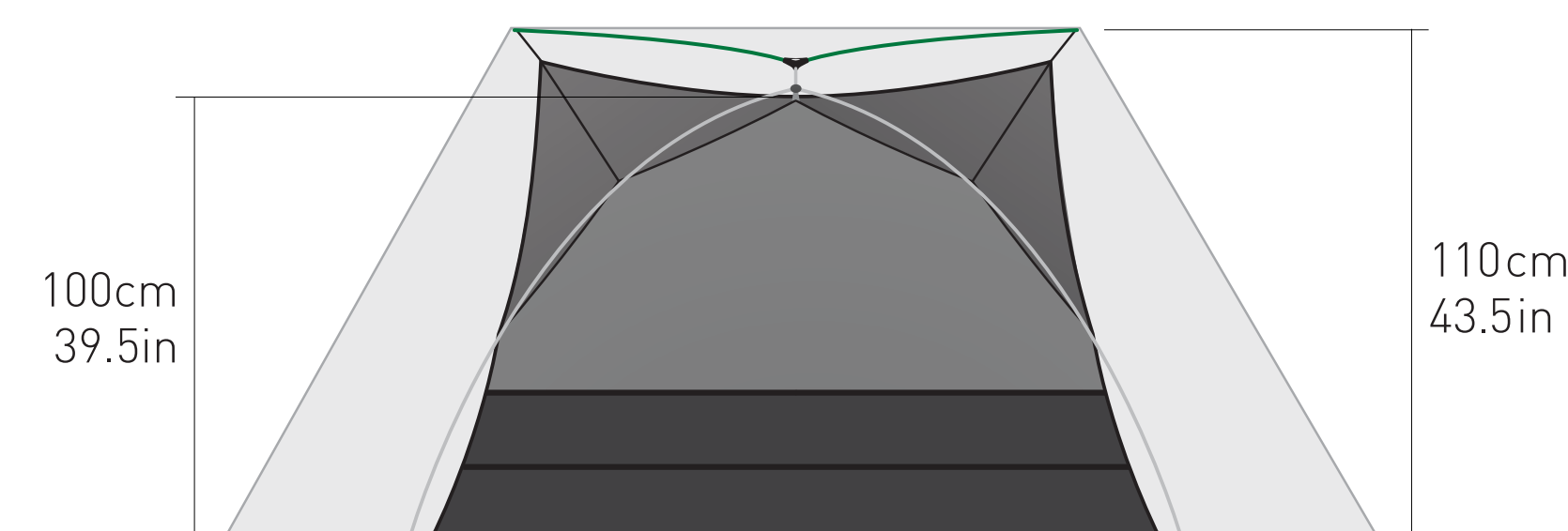

TELOS TR3 TR3 PLUS

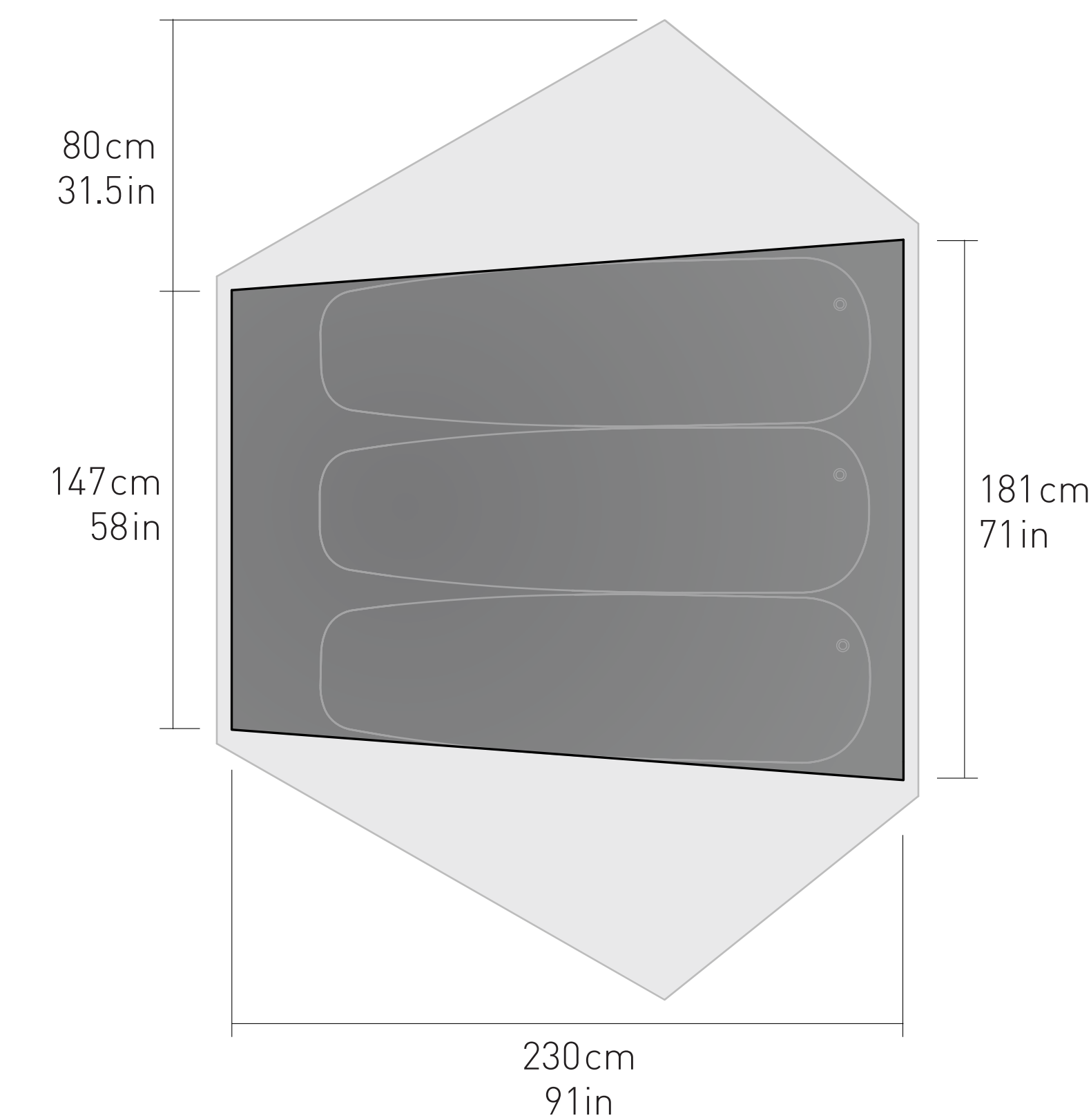
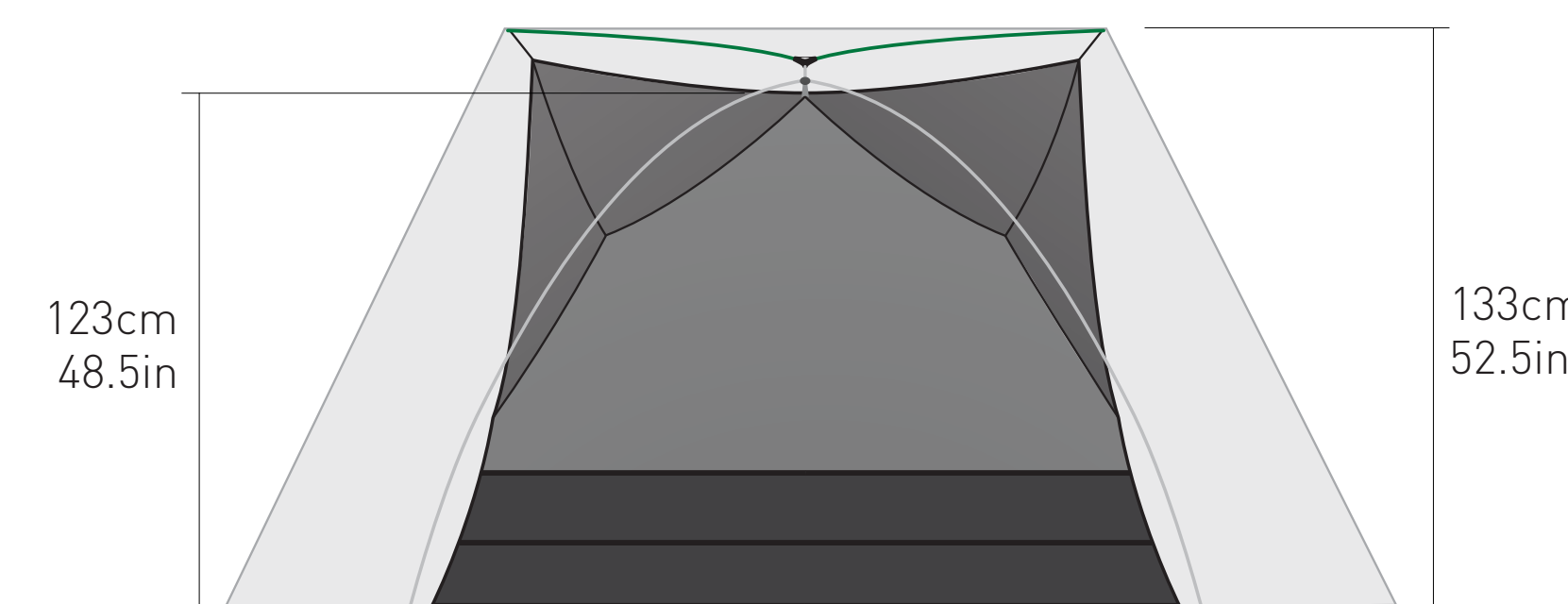



TELOS TR2

PRODUCT	CODE	INNER CONSTRUCTION	POLE TYPE	PACKED DIMENSIONS	MIN TRAIL WEIGHT	PACKED WEIGHT	COLOUR	RRP
 NEW TELOS TR2 BIKEPACK	ATS042051-170401	Mesh / Fabric	DAC Featherlite NSL 8.5mm & 9.0mm Anodised Aluminium	15 x 22 x 30cm 5.9 x 8.7 x 11.8in	1507g 53.2oz	1914g 67.5 oz	<input checked="" type="radio"/>	
	ATS042051-170502						<input type="radio"/>	
TELOS TR2	ATS2040-01170409	Mesh / Fabric	DAC Featherlite NSL 8.5mm & 9.0mm Anodised Aluminium	Ø13 x 48cm Ø5.1 x 18.9in	1482g 52.3 oz	1657g 58.4 oz	<input checked="" type="radio"/>	
	ATS2040-01170501						<input type="radio"/>	
TELOS TR2 PLUS	ATS2040-01170402	Fabric / Fabric	DAC Featherlite NSL 8.5mm & 9.0mm Anodised Aluminium	Ø13 x 48cm Ø5.1 x 18.9in	1531g 54 oz	1706g 60.2 oz	<input checked="" type="radio"/>	
	ATS2040-01170510						<input type="radio"/>	

TELOS TR3

PRODUCT	CODE	INNER CONSTRUCTION	POLE TYPE	PACKED DIMENSIONS	MIN TRAIL WEIGHT	PACKED WEIGHT	COLOUR	RRP
TELOS TR3	ATS2040-01180411	Mesh / Fabric	Featherlite NSL 9.6mm & PF 9.5mm Anodised Aluminium	Ø15 x 49cm Ø5.9 x 19.3in	1921g 67.8 oz	2118g 74.7 oz	<input checked="" type="radio"/>	
	ATS2040-01180505						<input type="radio"/>	
TELOS TR3 PLUS	ATS2040-02180406	Fabric / Fabric	Featherlite NSL 9.6mm & PF 9.5mm Anodised Aluminium	Ø15 x 49cm Ø5.9 x 19.3in	2127g 71.7 oz	2229g 78.6 oz	<input checked="" type="radio"/>	
	ATS2040-02180512						<input type="radio"/>	



ALTO TR

TR1 TR1 PLUS TR2 TR2 PLUS

Our semi-freestanding Alto tents are our lightest and most compact models—perfect for weight-conscious backpackers.

Available in one-person and two-person configurations.



*Alto TR2 pictured



Fairshare storage system allows you to split the load between your fellow campers.



ALTO TR1 TR2

Ultra-lightweight 15D polyester high-airflow mesh inner for maximum ventilation and no-see-um insect protection.



ALTO TR1 PLUS TR2 PLUS

Breathable 20D Nylon fabric canopy with a 20D Sil-PeU coated, seam-taped 2500mm waterhead floor for dependable performance in cold and wet conditions.

ALTO TR1 TR1 PLUS

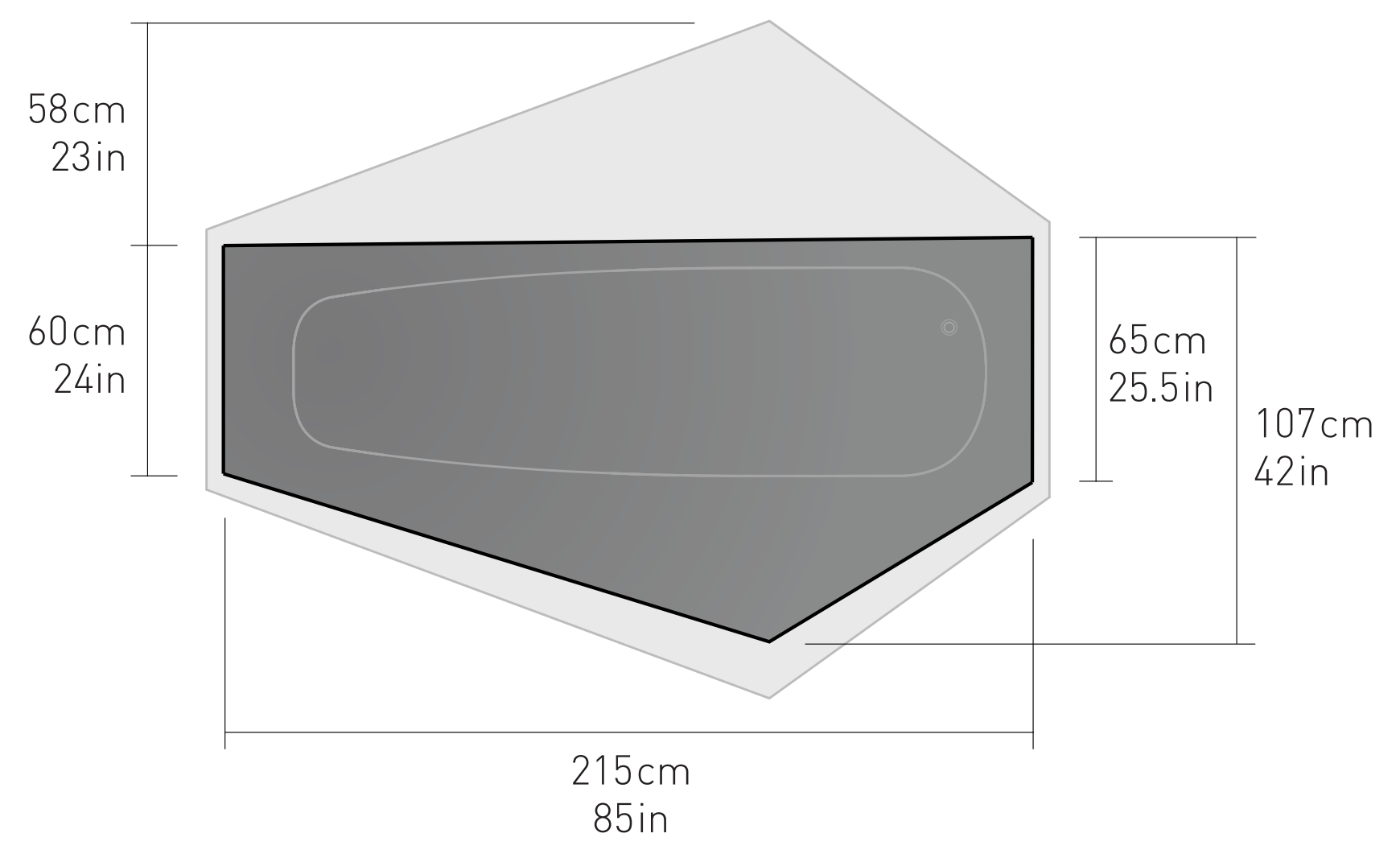
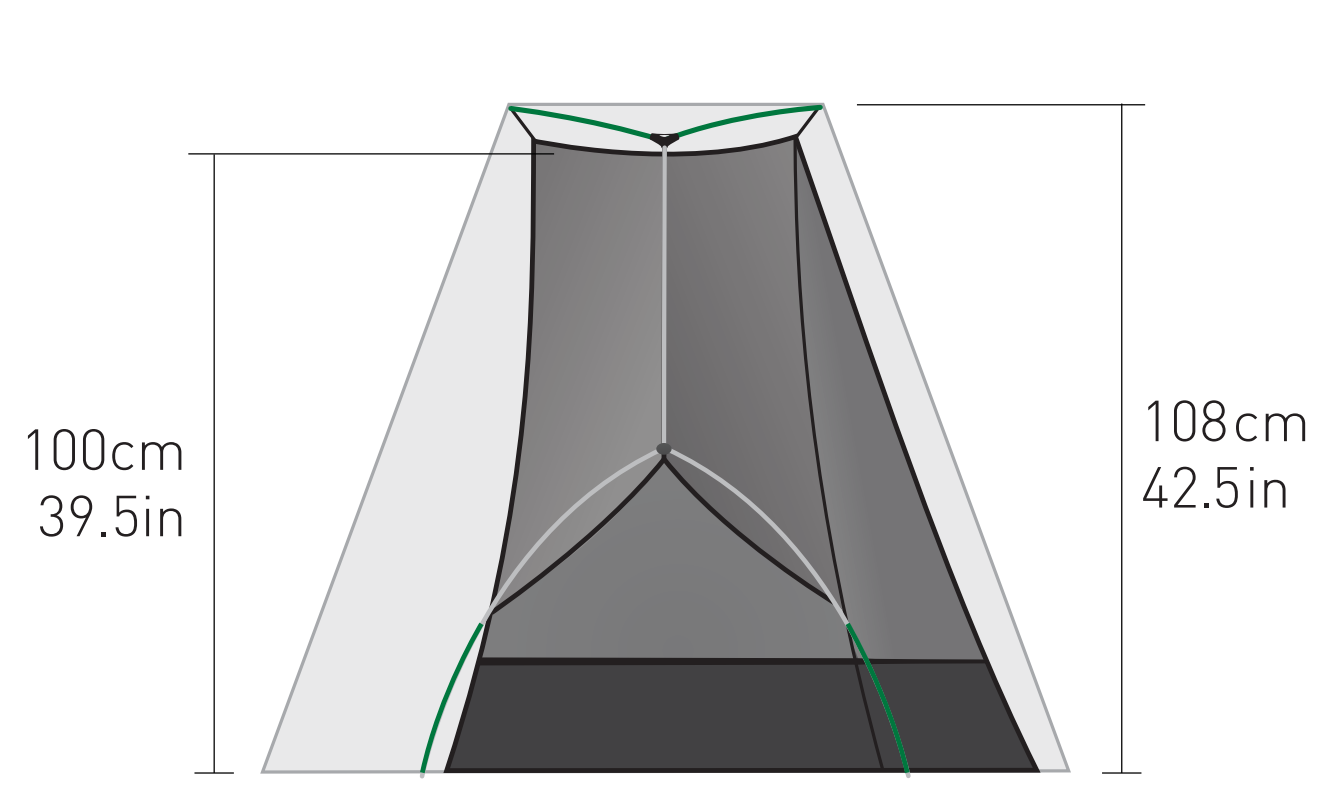

ALTO TR2 TR2 PLUS

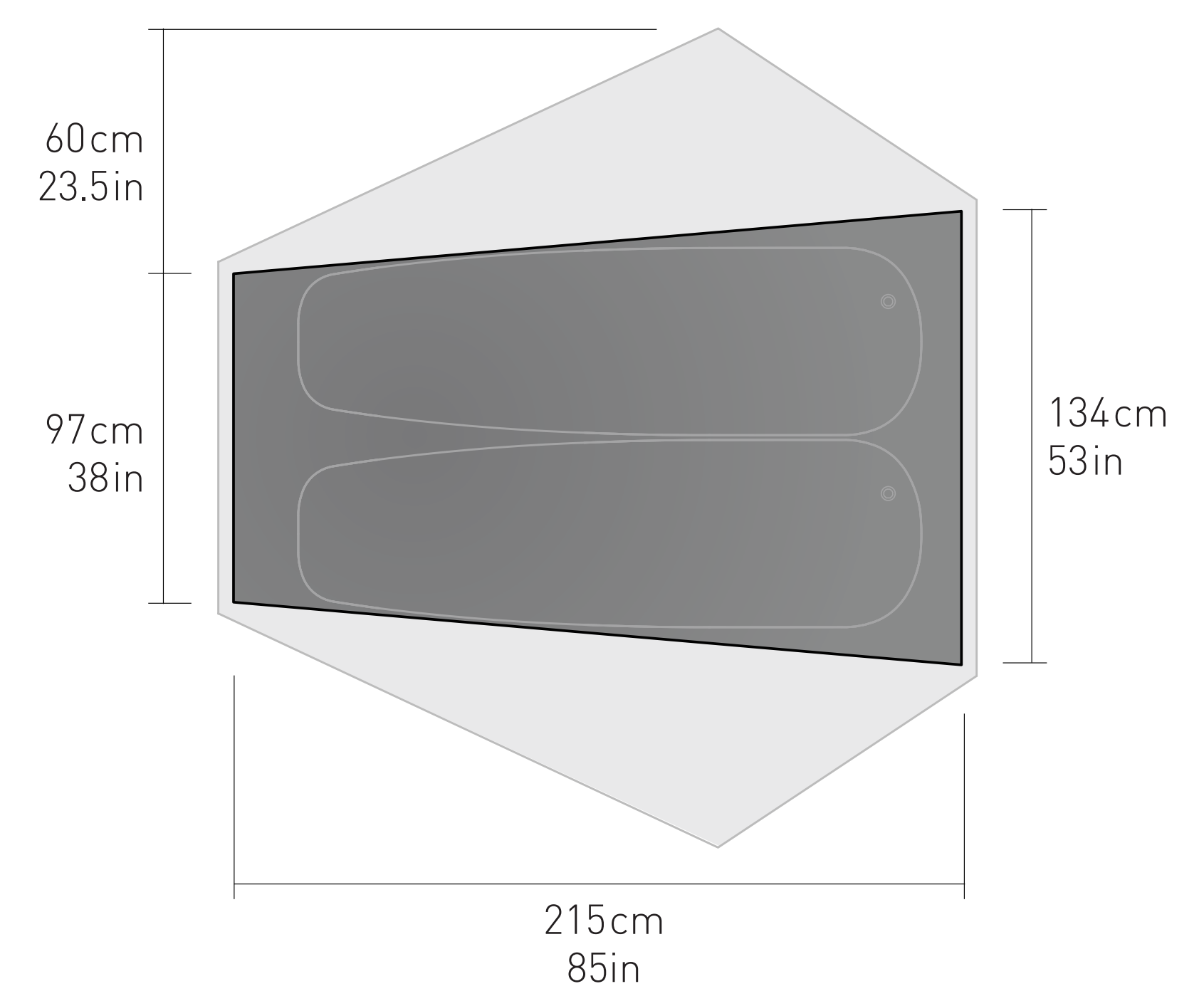
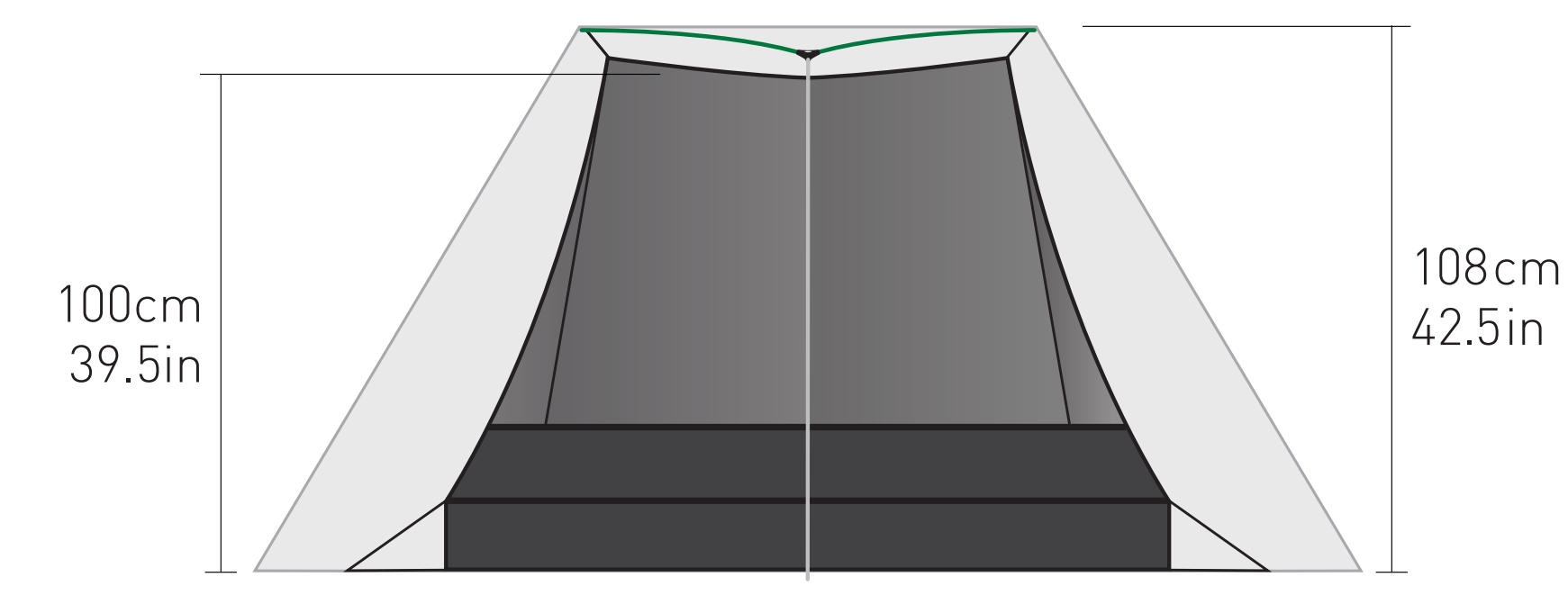

**ALTO TR1**

PRODUCT	CODE	INNER CONSTRUCTION	POLE TYPE	PACKED DIMENSIONS	MIN TRAIL WEIGHT	PACKED WEIGHT	COLOUR	RRP
ALTO TR1	ATS2039-01160410	Mesh / Fabric	DAC Featherlite NSL 8.7mm, PF 9.5mm & 9.8mm Anodised Aluminium	Ø11 x 44cm Ø4.3 x 17.3in	938g 33.1 oz	1110g 42.9 oz	<input checked="" type="radio"/>	
	ATS2039-01160501						<input type="radio"/>	
ALTO TR1 PLUS	ATS2039-02160402	Fabric / Fabric	DAC Featherlite NSL 8.7mm, PF 9.5mm & 9.8mm Anodised Aluminium	Ø11 x 44cm Ø4.3 x 17.3in	1056g 37.2 oz	1228g 43.3 oz	<input checked="" type="radio"/>	
	ATS2039-02160511						<input type="radio"/>	

ALTO TR2

PRODUCT	CODE	INNER CONSTRUCTION	POLE TYPE	PACKED DIMENSIONS	MIN TRAIL WEIGHT	PACKED WEIGHT	COLOUR	RRP
ALTO TR2	ATS2039-01170409	Mesh / Fabric	DAC Featherlite NSL 8.7mm, PF 9.5mm & 9.8mm Anodised Aluminium	Ø12 x 52cm Ø4.7 x 20.5in	1156g 40.8 oz	1340g 47.3 oz	<input checked="" type="radio"/>	
	ATS2039-01170505						<input type="radio"/>	
ALTO TR2 PLUS	ATS2039-02170406	Fabric / Fabric	DAC Featherlite NSL 8.7mm, PF 9.5mm & 9.8mm Anodised Aluminium	Ø12 x 52cm Ø4.7 x 20.5in	1247g 44.9 oz	1458g 51.4 oz	<input checked="" type="radio"/>	
	ATS2039-02170512						<input type="radio"/>	



TENTS, TARPS + SHELTER ACCESSORIES

From ultralight Footprints to space-optimising Gear Lofts—complete your tent set-up with customised accessories.





EXPLORE THE RANGE

TENT ACCESSORIES



FOOTPRINTS



HANGOUT MODE
POLESET



GEAR LOFTS



GUY LINES



TENT PEGS

SHELTER + TARP ACCESSORIES



GROUNDSHEETS



TENT FOOTPRINTS

The minimalist Lightfoot covers the outline of your tent tub floor while the full coverage Bigfoot extends to include vestibules.

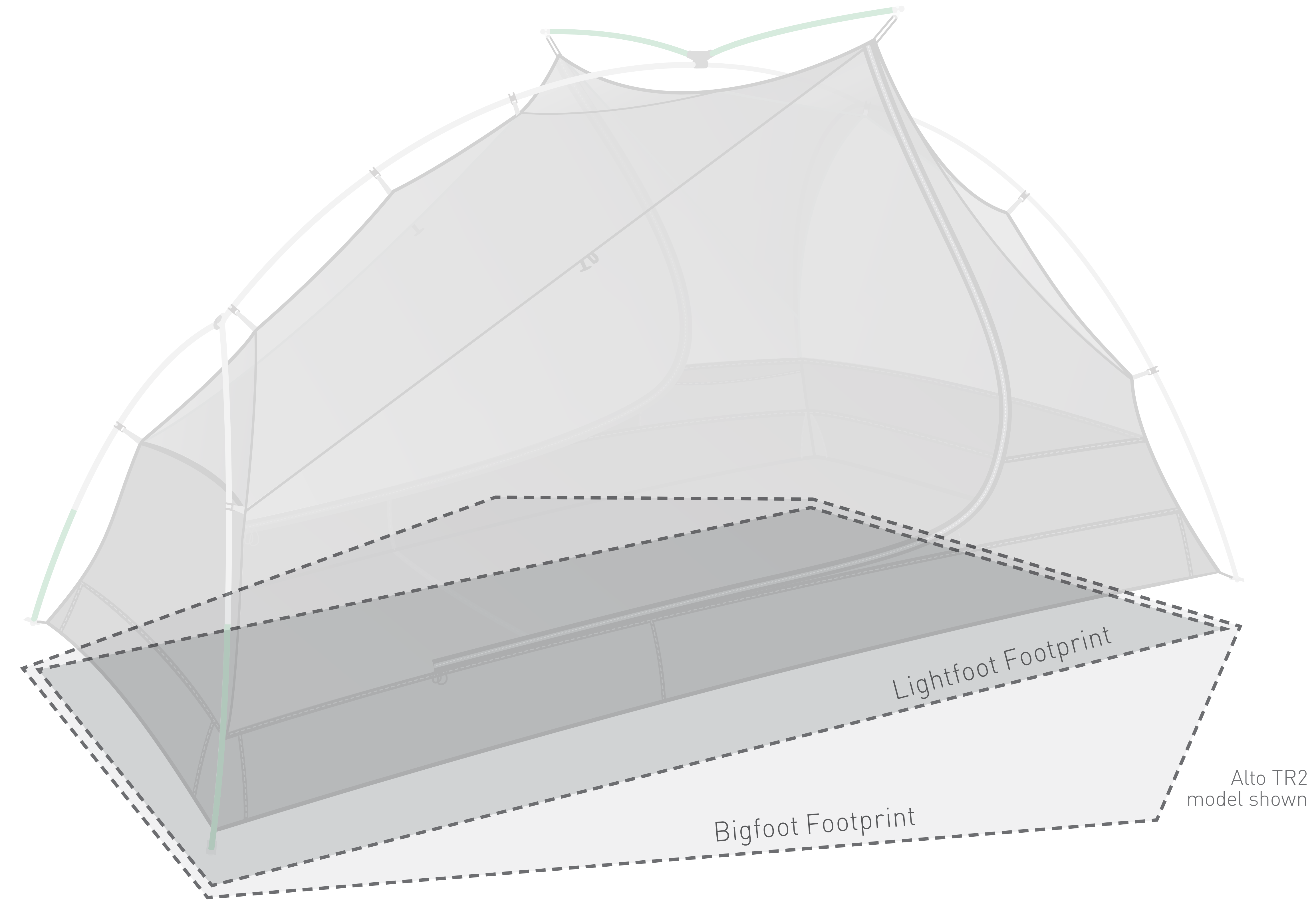

Protect your tent floor from abrasion, tears and dirt with our durable and lightweight footprints.



Perfect fit for an easy Fly Only tent set-up



Comes with a lightweight storage pouch

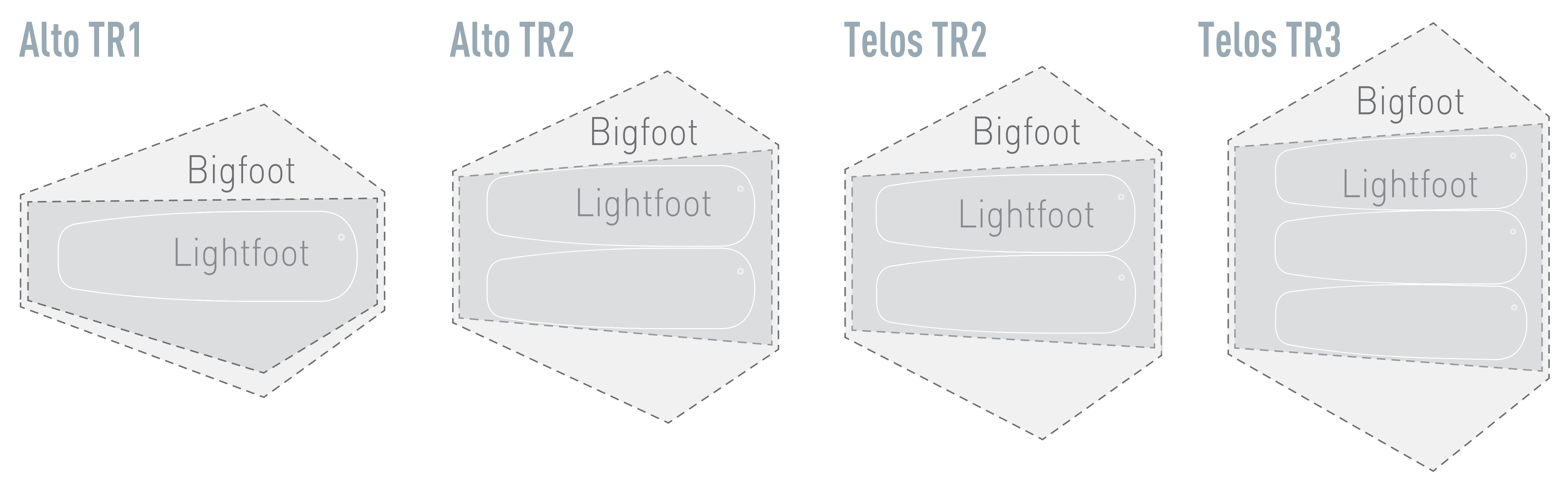

Strong Hypalon attachment points are flexible and secure



HANGOUT MODE POLESET

Activate Hangout Mode in your Telos tent with these custom DAC Featherlite NSL poles..

FEATURES

- Easy-to-use pole strap to keep the two-pole set bundled together
- Three-segment poles fold away to fit with the main tent pole set



GEAR LOFT

Stash gear within easy reach and keep it off the tent floor.

FEATURES

- Perfect for clothes when delayering before bed
- Easily attach and detach with quick-connect V-Toggles

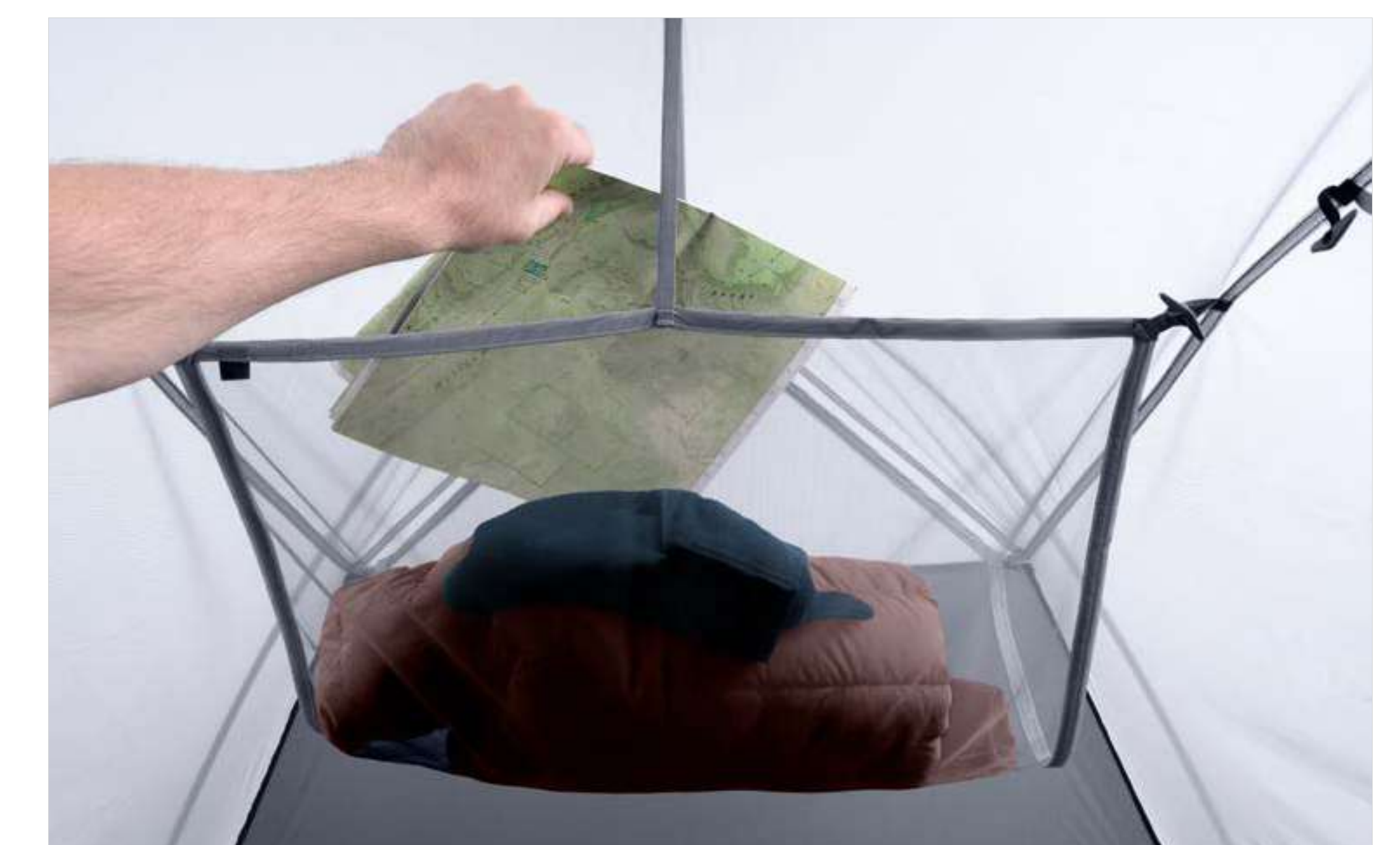



GROUND CONTROL GUY CORDS

Make it easy to weather the storm with our quick-connect guy cords for tents and shelters.

FEATURES

- Quick-connect, knot-free V-Toggle attachment for ease of use
- Integrated cord length adjuster—multiple guy cords can also join together for extra length
- Tightly woven, reflective cord resists tangling

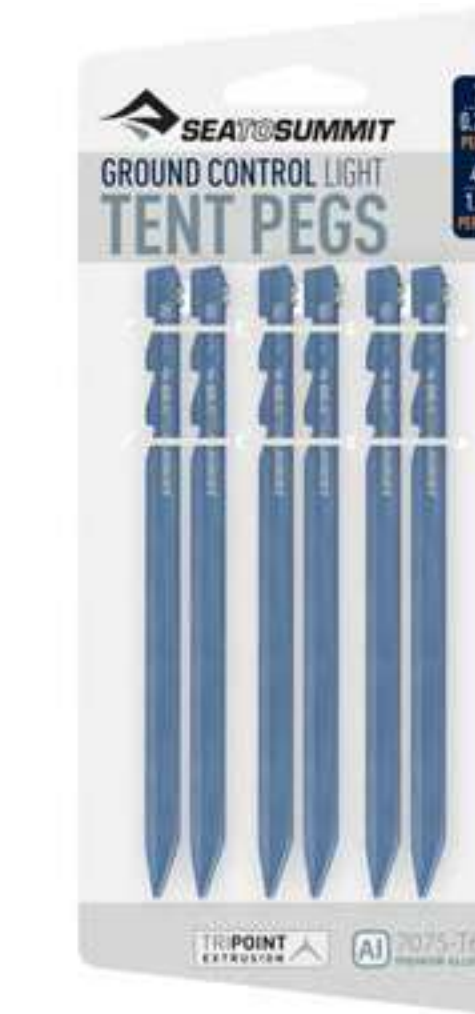
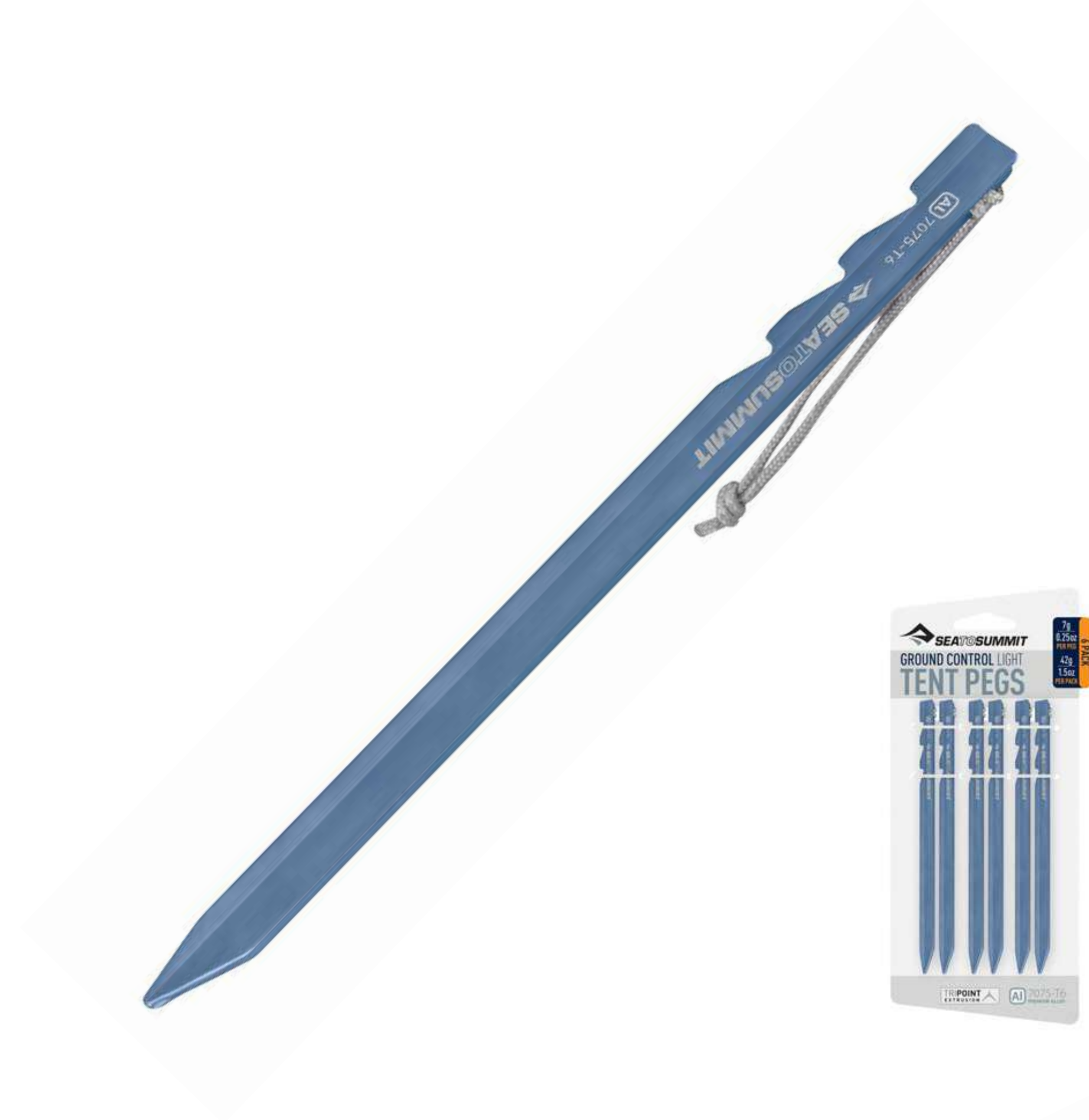

GROUND CONTROL LIGHT PEGS

Strong and ultralight premium 7 series aircraft alloy (7075-T6) tent pegs with a unique TriPoint shape.

FEATURES

- Rigid TriPoint design maximises grip in varied ground conditions
- Multiple notches keep guy cord low and secure in hard ground
- Reflective pull-cords for easy removal and improved visibility at night



GROUND CONTROL TENT PEGS

Light and strong three-sided replacement pegs for your tent, tarp or shelter.

FEATURES

- Reflective cord and luminescent pull loop for peg extraction
- Multi-height guy points to reduce leverage on the peg
- Available as a pack of 8 pegs including Ultra-Sil stuff sack, or a bulk refill pack for individual sale





Escapist **GROUND SHEET**

Protect your shelter floor or sleeping mat from groundwater, thorns, mud, and dirt with this tough, lightweight and waterproof ground sheet.

FEATURES

- Sized to fit under both our Escapist 15D Tarp shelters and our Escapist Ultra-Mesh Bug Tent







TENT ACCESSORIES

PRODUCT	SUITS TENT	MODEL	CODE	DIMENSIONS	PACKED DIMENSIONS	WEIGHT	MATERIALS	RRP
 Footprint	Alto TR1	Lightfoot	ATS6039-06160502	112 x 225.5cm 44.1 x 88.8 in	14 x 16 x 3cm 5.5 x 6.3 x 1.2 in	171g 6 oz	68D PU coated Polyester, 1200mm waterhead	
		Bigfoot	ATS6039-05160501	166 x 225.5cm 65.4 x 88.8 in	20 x 16 x 4cm 7.9 x 6.3 x 1.6 in	224g 7.9 oz		
	Alto TR2	Lightfoot	ATS6039-06170504	148 x 222cm 54.3 x 87.4 in	14 x 16 x 3cm 5.5 x 6.3 x 1.2 in	237g 8.4 oz		
		Bigfoot	ATS6039-05170503	244 x 222cm 96.1 x 87.4 in	20 x 16 x 4cm 7.9 x 6.3 x 1.6 in	350g 12.3 oz		
	Telos TR2	Lightfoot	ATS6040-06170502	144 x 222cm 56.7 x 87.4 in	14 x 16 x 3cm 5.5 x 6.3 x 1.2 in	243g 8.6 oz		
		Bigfoot	ATS6040-05170501	266 x 222cm 104.7 x 87.4 in	20 x 16 x 4cm 7.9 x 6.3 x 1.6 in	382g 13.5 oz		
	Telos TR3	Lightfoot	ATS6040-06180504	191 x 235cm 75.2 x 92.5in	14 x 16 x 3cm 5.5 x 6.3 x 1.2 in	338g 11.9 oz		
		Bigfoot	ATS6040-05180503	349 x 235cm 137.4 x 92.5in	20 x 16 x 4cm 7.9 x 6.3 x 1.6 in	511g 18 oz		
 Telos Hangout Mode Pole Set			ATS0040-00130501	125cm 4.1 ft	ø3 x 45cm 1.2 x 17.8 in	135g 4.8 oz	DAC Featherlite NSL 8.5mm & 9.0mm Anodised Aluminum	
 Gear Loft	Alto TR1		ATS0039-01160501	100 x 39 x 0.5cm 39.4 x 15.4 x 0.2 in		24g 0.8 oz	15D Polyester Mesh	
	Alto TR2		ATS0039-01170502	89 x 56 x 0.5cm 35 x 22 x 0.2 in	23 x 13 x 2.5cm 9 x 5.1 x 1 in	28g 1 oz		
	Telos TR2		ATS0040-01170501	72 x 59 x 0.5cm 28.3 x 23.2 x 0.2 in		24g 0.8 oz		
	Telos TR3		ATS0040-01180502	68 x 85 x 0.5cm 26.8 x 33.4 x 0.2 in		26g 0.9 oz		



TENT ACCESSORIES

PRODUCT NAME	CODE	SIZE	DIMENSIONS	WEIGHT	MATERIALS	RRP
 Ground Control Guy Cords	ATS0085-00121702	4 pack	2 x 2.2m 7ft 3 in & 2 x 1m 3ft 3 in	18g 0.6 oz	UV-resistant Polyester cord	
 Ground Control Light Pegs	ATS0085-00120201	6 pack	1 x 15cm 0.4 x 5.7 in	7g 0.2 oz (ea)	7075-T6 Anodised Aluminium Alloy	
 Ground Control Tent Pegs	APEGS8PK	8 Pack	1 x 20cm 0.4 x 8 in	118g 4 oz	7075-T6 Anodised Aluminium Alloy	
	APEG	Bulk (x20)		12g 0.4 oz (ea)		

TARP + SHELTER ACCESSORIES

PRODUCT NAME	CODE	DIMENSIONS	PACKED DIMENSIONS	WEIGHT	MATERIALS	RRP
 Escapist Ground Sheet	AESCGS	220 x 130cm 86.6 x 51.2 in	20 x 11 x 5cm 7.87 x 4.33 x 1.9 in	165g 5.8 oz	Lightweight Tyvek®	



TARPS + SHELTERS

Technical, versatile and ultra-lightweight
—loved by gram counters.





15D ULTRA-SIL™



Escapist 15D TARP

Protects two sleepers from the rain when set up close to the ground as an A-Frame—doubles as a tent awning, sun shelter or kitchen area.

FEATURES

- Reinforced corners with cord lock and reflective guy lines (which can be adjusted from under the tarp)
- To make a tarp shelter place a trekking pole through the circular bar-tack

SIZES M / L



Escapist ULTRA-MESH INNER TENT

Persistent insects meet their match—and you'll barely know it's in your pack.

FEATURES

- Siliconised Nylon tape-seamed tub floor with generous splash skirt and curved zip entrance
- Strong and durable black fine mesh upper for better visibility



310 HOLES per cm²





TARPS + SHELTERS

PRODUCT NAME	CODE	SIZE	DIMENSIONS	COLLAPSED DIMENSIONS	WEIGHT	MATERIALS	RRP
 Escapist 15D Tarp	AESCTARPM	Medium	260 x 200cm 102.4 x 78.7 in	ø8.5 x 19cm ø3.3 x 7.5 in	300g 10.6 oz	15D Sil/PU coated Nylon, 1,200mm waterhead	
	AESCTARPL	Large	300 x 300cm 118.1 x 118.1 in	ø9 x 23cm ø3.5 x 9.1 in	440g 15.5 oz		
 Escapist Ultra-Mesh Inner Tent	AESCUMBUGTENT		220 x 120 x 100cm 86.6 x 47.2 x 39.4 in	ø10 x 23cm ø3.9 x 9.1 in	385g 13.6 oz	15D Sil/PU coated Nylon, 1,200mm waterhead, 15D Nylon Mesh	

SLEEP

IMPROVE SLEEP.
INCREASE
PERFORMANCE.



SLEEPING BAGS



LINERS



SLEEPING MATS



PILLOWS



HAMMOCKS



WOMEN'S SPECIFIC SLEEP SYSTEMS

More warmth and room to move for a better sleep outdoors.

Statistically, women tend to sleep a few degrees colder than men and particularly feel the cold in the feet and hands. And while this may not be a surprise, on average, Women's height, sleeping style and metabolism can differ too.

This is why Sea to Summit offers the broadest range of women's specific sleeping bags and mats on the market. Designed with more insulation and room to move, our bags and mats are engineered to compliment the way women typically sleep, while removing unnecessary weight and bulk.



WARMTH WHERE IT'S NEEDED

Extra insulation in core zones increases overall warmth, particularly in the areas where women typically feel the cold the most.

WOMEN'S SPECIFIC FIT

Narrower in the shoulders with more leg and hip room for side sleepers and typical women's body shapes.

ENGINEERED FOR WOMEN



SLEEPING BAGS

The devil is in the detail.

You will find a Sea to Summit sleeping bag that will be perfect for any scenario or environment, giving you a better sleep and helping you perform better.

From ultra-light through hiking, to high-altitude mountaineering or vehicle supported expeditions, we've made sure to think about all the little details that will keep you more comfortable and better rested.

With 19 models and 98 variants on offer, we've tried to create a sleeping bag or quilt for any situation that you might find yourself in.

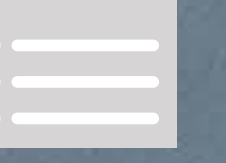

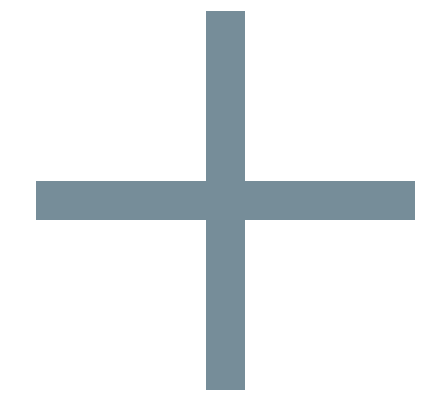

OUR SLEEPING BAGS
FEATURE:

QUALITY MATERIALS



CO DWR

PFC-Free Fabrics with CO treatment provide environmentally friendly resistance to condensation or other moisture.

INDEPENDENTLY TESTED

All of our sleeping bags are independently tested in Norway to the EN/ISO standard for published Sleeping Bag warmth.

TECHNICAL FABRICS

Are selected balancing weight, breathability, quietness, water resistance, and comfort for each model.

YKK ZIPPERS

YKK Zippers are strong and durable.

DESIGN DETAILS



FREE FLOW ZIP SYSTEM

Our Free Flow Zip System offers greater versatility and comfort across a wider temperature range.



ZIP COUPLING

Most bags are designed to be zipped together to create double sized sleeping sacks.

INTERNAL POCKETS

Small Zippered Pockets inside your bag provide space for valuables or small electronics in freezing conditions.



QUILT LOCK SYSTEM

Every Sleeping Bag can combine with a quilt to increase warmth.

ZIPPER DRAFT TUBES

Zip Draft Tubes with anti-snap prevent cold leaching in via the zipper opening.

INTERNAL CORD TUNNELS

Our Cord Tunnels are buried within Draft Tubes to keep drawcords from irritating your face or neck.

CLEVER ADJUSTMENT

Hood and Collar Draft Tubes all have dual adjusters, one on each side, for even cinching and maximum warmth.

STORAGE SOLUTIONS

AT HOME STORAGE

Zippered Storage Cell for keeping your bag lofty when packed away at home.

BETTER COMPRESSION

Three-strap “flip top” compression sacks for easy storage and packing (except Treeline).





DOWN SLEEPING BAGS

Even in this modern day of synthetics, down is still the best insulation for sleeping bags.

It has the best warmth to weight ratio, it is the most durable sleeping bag insulation, and if looked after (and occasionally washed) it will last a lifetime.



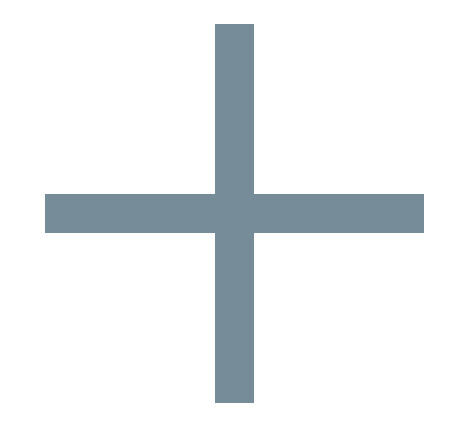

OUR DOWN SLEEPING BAGS FEATURE:

QUALITY MATERIALS



RESPONSIBLE DOWN STANDARD (RDS)

The RDS is helping to shift the entire down and feather industry towards more humane animal rearing and handling practices. Overseen by the industry leading Textile Exchange, the RDS requires independent, third party assessments of all aspects of animal rearing and handling throughout the entire supply chain.

To find out more about how the RDS is improving animal welfare during down collection, please visit responsibledown.org

DESIGN DETAILS

ULTRA-DRY DOWN

Ultra-Dry Down is a PFC-free, permanent polymer treatment that absorbs 30% less moisture and dries 60% quicker than untreated down.

UNIQUE DOWN CERTIFICATE

Each bag includes a Batch Test Report from the International Down and Feather Laboratory to certify the loft and quality of down used.

MINIMUM FILL RATING

All down used in our bags exceeds the published loft that is specified for that model.

BESPOKE DESIGN

The baffle height in our bags is adjusted for each variant, so that the down insulation has the perfect amount of space in which to achieve maximum loft.

DIFFERENTIAL CUT

A differentially cut shell design allows the down to expand outward for better lofting and also reduces the chance of cold spots.

VERTICAL CHEST BAFFLES

Vertical Chest Baffles prevent down migration and cold spots, particularly for side sleepers.

SIDE BLOCK BAFFLES

Side Block Baffles prevents down shifting around, and maintains warmth where it is needed.



EXPLORE THE RANGE

ULTRA-DRY Down™
850+ Loft

ULTRA-DRY Down™
750+ Loft

ULTRA-DRY Down™
650+ Loft

600+ Loft

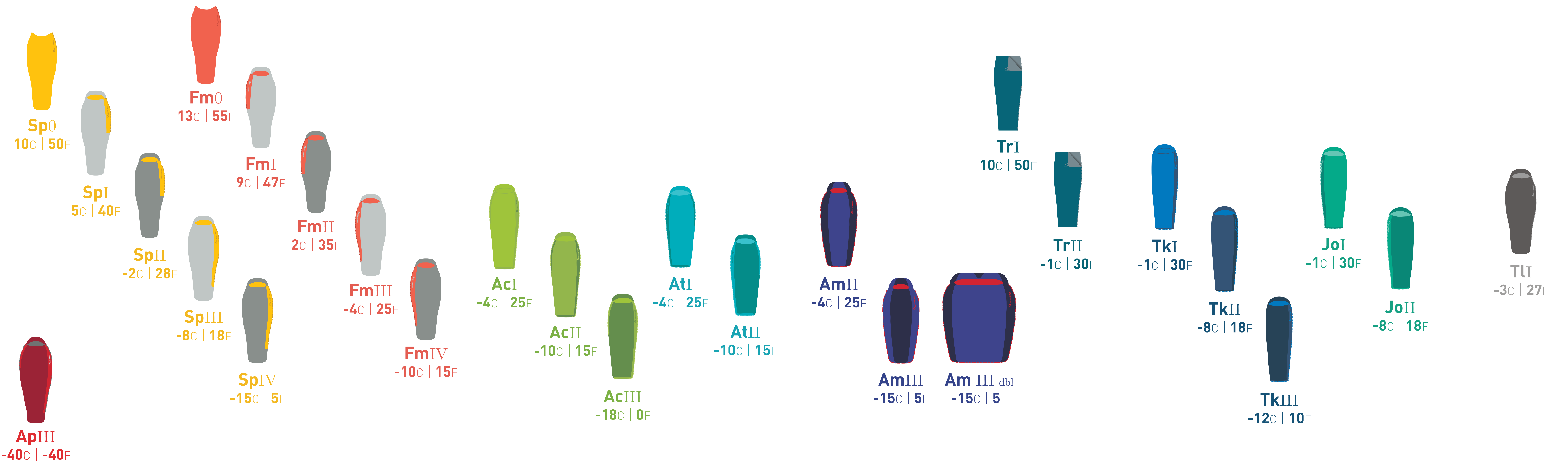
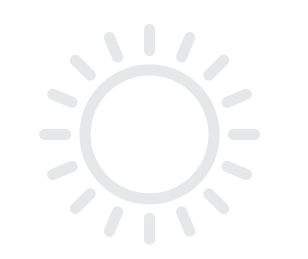



Alpine Ap



Our first choice for extreme cold and high altitude conditions where sleeping well can make or break an expedition.





Alpine Ap

Regular

160cm | 63"

142cm | 56"

131cm | 51"

<183cm | 6'

Long

168cm | 66"

150cm | 59"

145cm | 57"

<198cm | 6'6"

MAX USER HEIGHT

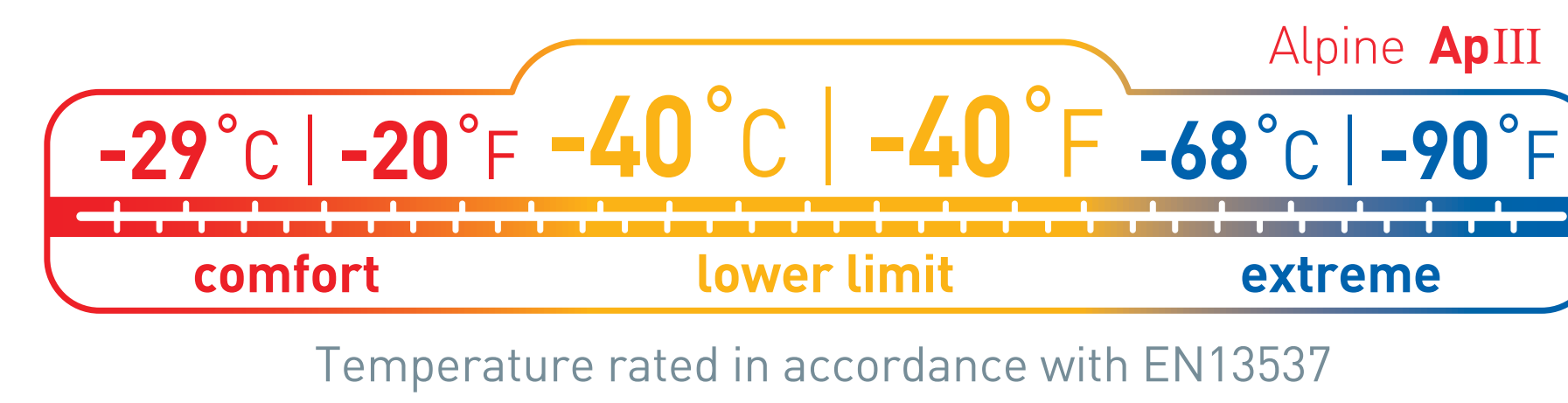
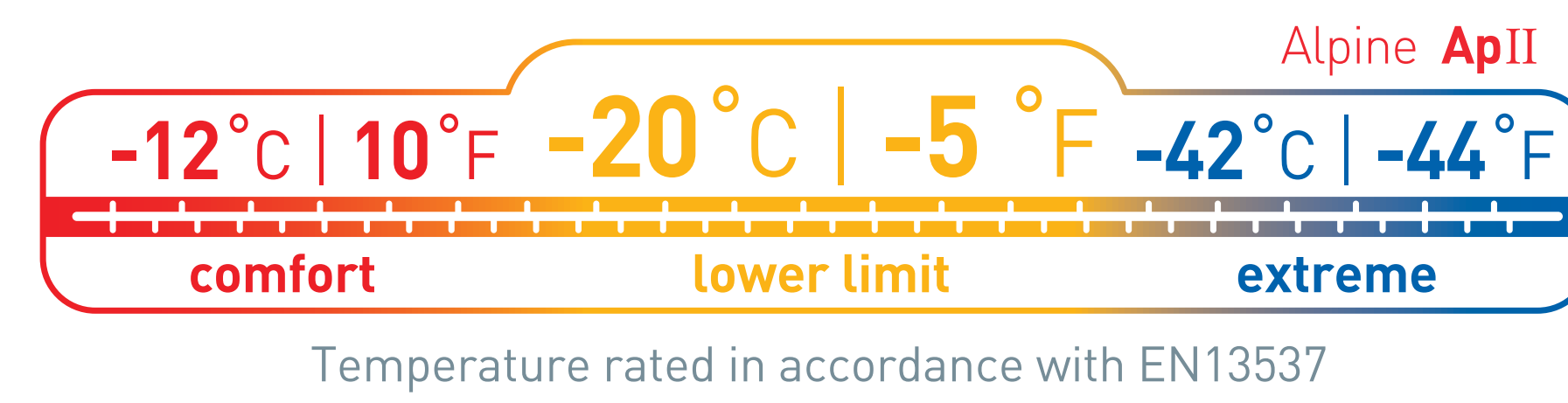
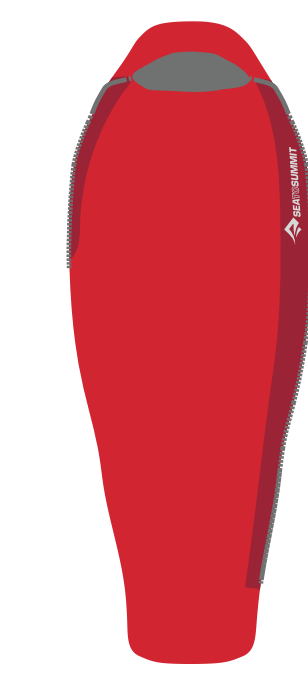

PRODUCT NAME	CODE	SIZE	MAX USER HEIGHT	WEIGHT	FILL WEIGHT	COMPRESSED SIZE	STORAGE	BAFFLE CONSTRUCTION	RRP
Alpine ApII	AAP2-R	Regular	<183 cm 6'	1340g 47.3 oz	800g 28.2 oz	ø24 x 21cm 9.3L	L / 20L	Vertical chest baffles, horizontal baffles lower half and base, box wall baffle construction throughout	
	AAP2-L	Long	<198 cm 6' 6"	1500g 52.9 oz	920g 32.5 oz	ø24 x 29cm 13.1L			
Alpine ApIII	AAP3-R	Regular	<183 cm 6'	1870g 66 oz	1250g 44.1 oz	ø27 x 26cm 14.7L	XL / 30L		
	AAP3-L	Long	<198 cm 6' 6"	2100g 74.1 oz	1440g 50.8 oz	ø27 x 34cm 19.5L			

- FABRIC** Waterproof, breathable NanoShell outer fabric
- ZIPS** Full length YKK #5 side zip, two sliders. 1/3 length YKK #5 Free-flow zip.
- PAIRING** This bag is NOT designed to pair with another
- SHAPE** Expedition shaped Mummy
- FOOTBOX** Anatomically shaped and oversized footbox can accommodate boots
- NECK DRAFT TUBE**
- SECURITY POCKET**



UPDATED

Spark Sp



The Spark Series spans everything from an ultralight liner to an expedition weight mid-winter bag. While the end usage of each variant is very different, they reflect a design ethos of matching weather conditions to the lightest bag possible.

ULTRA-DRY Down™
850+ Loft



Sp0

FEATURES

- Ideal for mid-summer fast hikes or adventure racing
- Doubles as a liner to significantly boost the warmth of a second bag



SpI



SpII

FEATURES

- Sizing provides extra room for both shoulders and hips while still maintaining insulation efficiency



SpIII



SpIV

FEATURES

- Expedition mummy bag sizing provides extra space for layered clothing or extra wriggle room
- Vertical baffles on chest optimises positions of down to prevent it moving during use





Spark Sp

Sp0

Regular

150cm | 59"

130cm | 51"

88cm | 35"

<183cm | 6' MAX USER HEIGHT

Long

158cm | 62"

138cm | 54"

97cm | 38"

<198cm | 6'6"

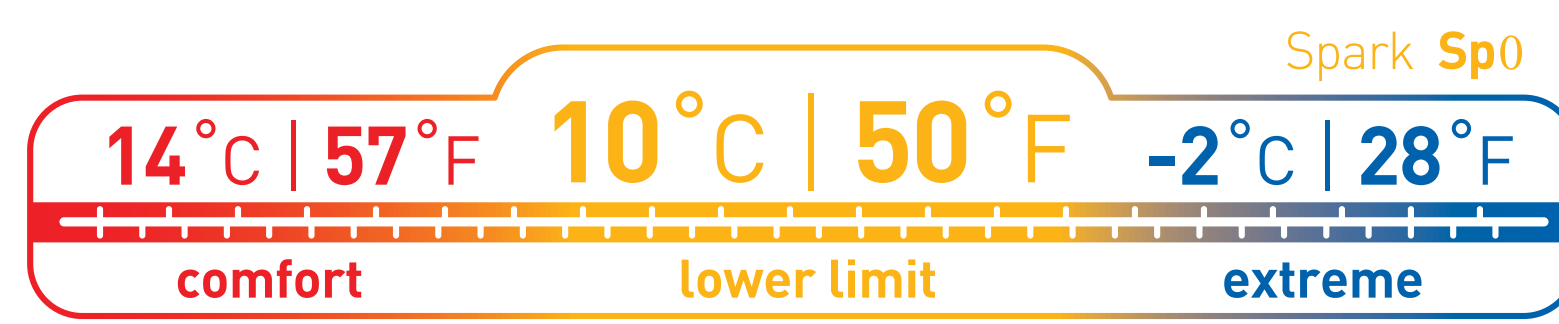

Temperature rated in accordance with EN13537

SpI

Regular

150cm | 59"

130cm | 51"

88cm | 35"

<183cm | 6' MAX USER HEIGHT

Long

158cm | 62"

138cm | 54"

97cm | 38"

<198cm | 6'6"

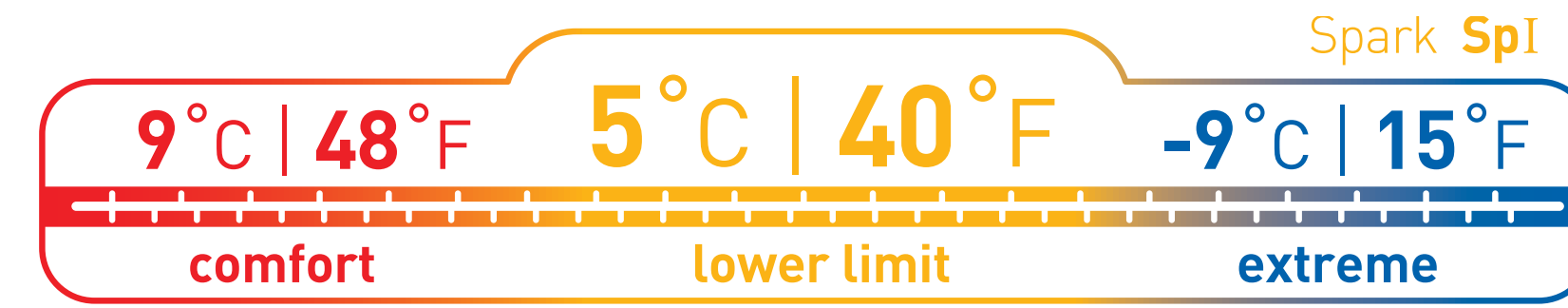
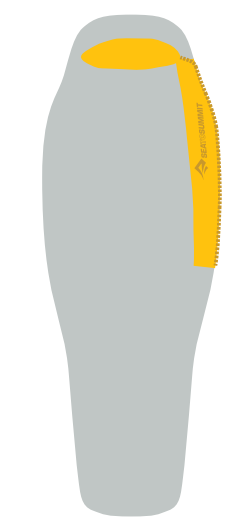

Temperature rated in accordance with EN13537

SpII

Regular

150cm | 59"

130cm | 51"

88cm | 35"

<183cm | 6' MAX USER HEIGHT

Long

158cm | 62"

138cm | 54"

97cm | 38"

<198cm | 6'6"

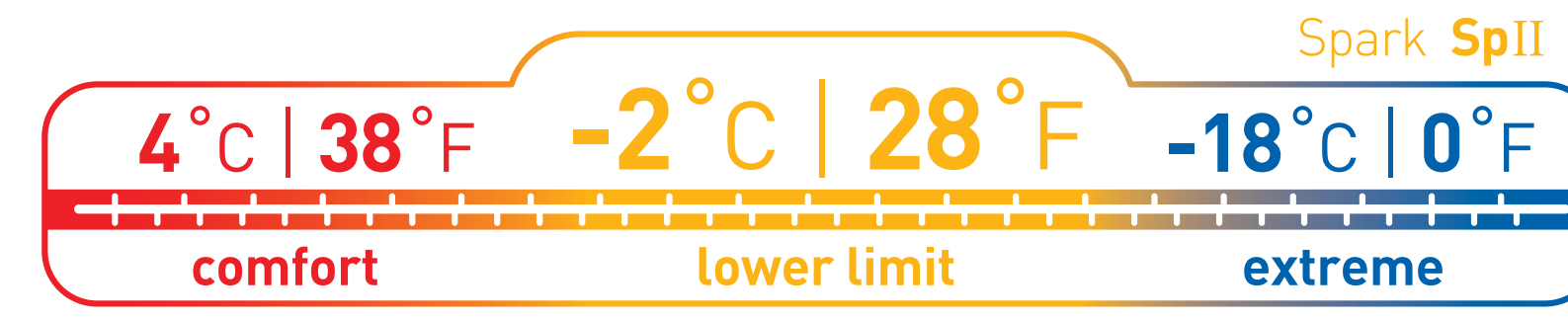

Temperature rated in accordance with EN13537

SpIII

Regular

155cm | 61"

135cm | 53"

94cm | 37"

<183cm | 6' MAX USER HEIGHT

Long

162cm | 64"

142cm | 56"

100cm | 39"

<198cm | 6'6"

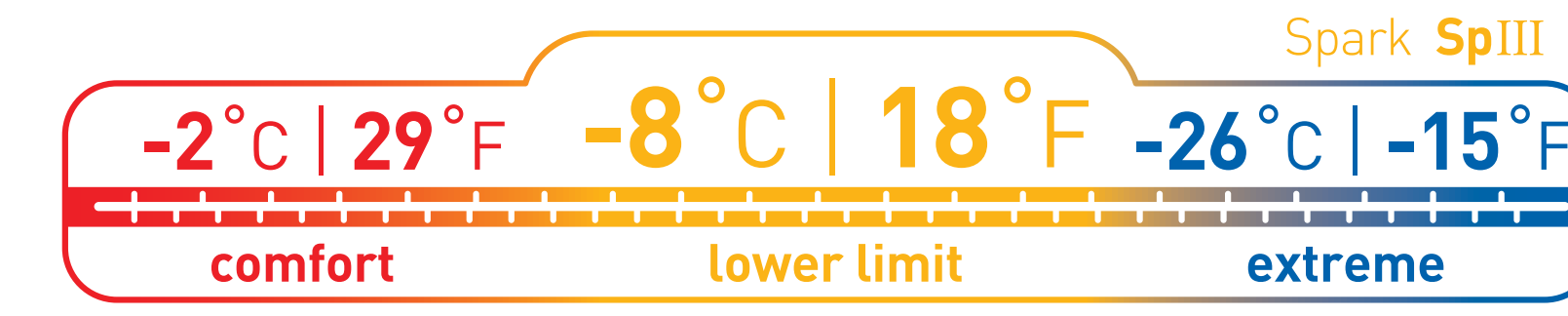

Temperature rated in accordance with EN13537

SpIV

Regular

155cm | 61"

135cm | 53"

94cm | 37"

<183cm | 6' MAX USER HEIGHT

Long

162cm | 64"

142cm | 56"

100cm | 39"

<198cm | 6'6"



Temperature rated in accordance with EN13537



PRODUCT NAME	CODE	SIZE	WEIGHT	FILL WEIGHT	COMPRESSED SIZE	STORAGE	BAFFLE CONSTRUCTION	RRP
Spark Sp0	ASP0-R	Regular	225g 7.9 oz	100g 3.5 oz	ø9.5 x 18cm 0.9L	Integrated stuff sack (uncompressed dimensions)	Narrow horizontal baffles, sewn through quilted construction throughout	
	ASP0-L	Long	260g 9.2 oz	115g 4.1 oz	ø10.5 x 20cm 1.3L			
Spark SpI	ASP1-R	Regular	340g 12 oz	180g 6.3 oz	ø11.5 x 14cm 1.5L	3XS / 2.5L	Vertical chest baffles, horizontal baffles lower half and base, sewn through quilted construction throughout	
	ASP1-L	Long	385g 13.6 oz	205g 7.2 oz	ø11.5 x 21cm 2.2L			
Spark SpII	ASP2-R	Regular	490g 18 oz	300g 10.6 oz	ø13 x 19cm 2.5L	2XS / 3.3L	Vertical chest baffles, horizontal baffles lower half and base, box wall baffles top half of bag and sewn through quilted	
	ASP2-L	Long	560g 20 oz	345g 12.2 oz	ø15.5 x 19cm 3.5L			
Spark SpIII	ASP3-R	Regular	665g 24 oz	430g 15.2 oz	ø15.5 x 24cm 4.6L	XS / 6L	Vertical chest baffles, horizontal baffles lower half and base, box wall baffle construction throughout	
	ASP3-L	Long	745g 26 oz	485g 17.1 oz	ø15.5 x 29cm 5.4L			
Spark SpIV	ASP4-R	Regular	880g 31 oz	620g 21.9 oz	ø18.5 x 25cm 6.6L	S / 10L		
	ASP4-L	Long	985g 34.7 oz	700g 24.7 oz	ø18.5 x 29cm 7.7L			

DESIGNED FOR

Unisex design

ZIPS

Sp 0-II: Light gauge YKK #3
Sp III-IV: YKK #5

PAIRING

These bags are NOT designed to pair with another

SHAPE

Sp 0-II: Contoured Mummy
Sp III-IV: Expedition Mummy

NECK DRAFT TUBE

Sp 0-I:
Sp II-IV:

SECURITY POCKET





UPDATED

Flame Fm



Engineered for women to provide extra warmth where needed, our Flame is what you reach for when you need a high performance sleeping bag but don't want to be weighed down by one.

ENGINEERED FOR WOMEN

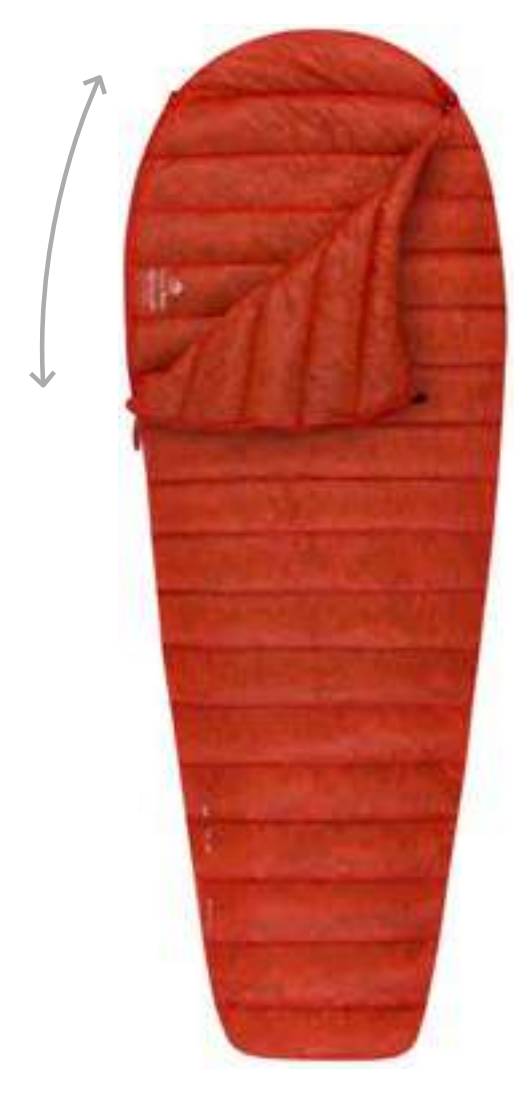

Fm0

FEATURES

- Ideal for mid-summer fast hikes or adventure racing
- Doubles as a liner to significantly boost the warmth of a second bag



FmI



FmII

FEATURES

- Lower part of the bag uses a sewn through horizontal baffle construction to minimise weight
- Includes hood draft collar



FmIII



FmIV

FEATURES

- Full side zip with two sliders provides easy access and extra ventilation options





Flame Fm



Fm0

Regular	Long
146cm 57"	152cm 58"
136cm 53"	142cm 56"
88cm 35"	94cm 38"
<183cm 6'	<198cm 6'6"

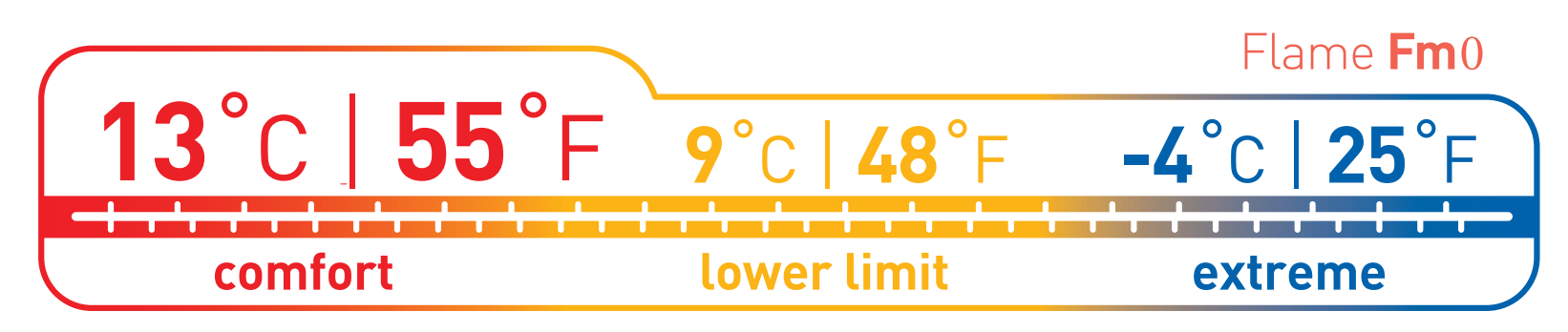
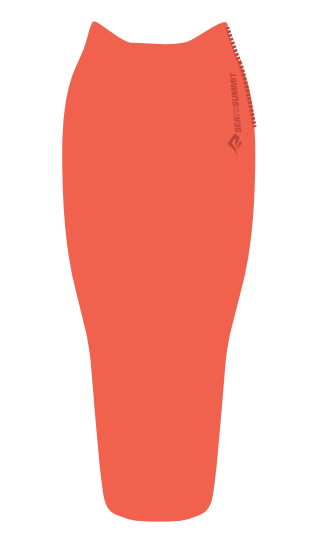

Temperature rated in accordance with EN13537

FmI

Regular	Long
146cm 57"	152cm 58"
136cm 53"	142cm 56"
88cm 35"	94cm 38"
<183cm 6'	<198cm 6'6"

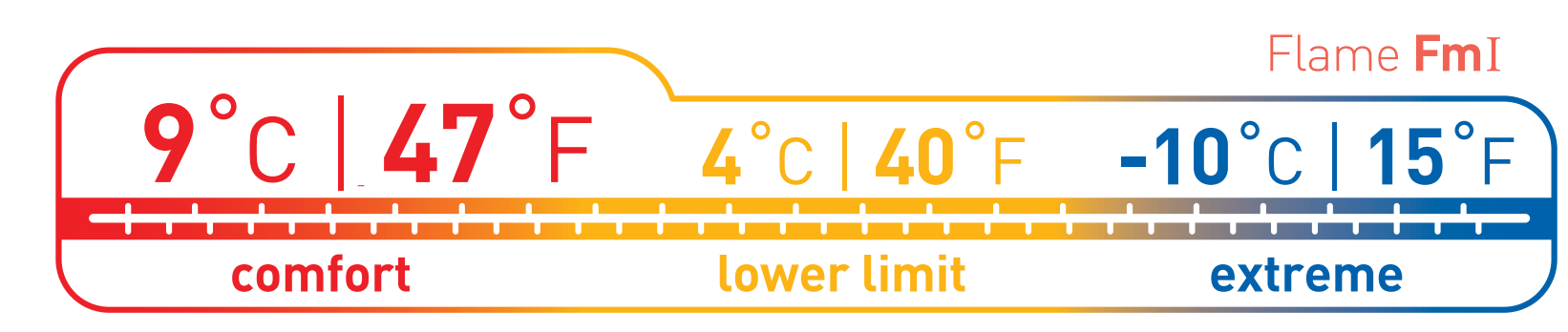
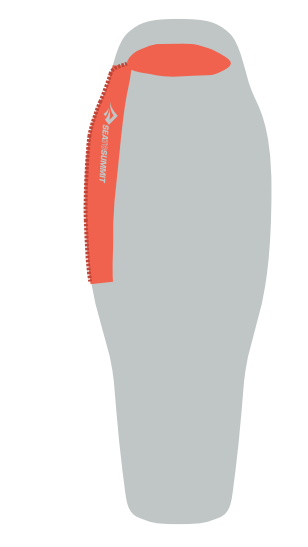

Temperature rated in accordance with EN13537

FmII

Regular	Long
146cm 57"	152cm 58"
136cm 53"	142cm 56"
88cm 35"	94cm 38"
<183cm 6'	<198cm 6'6"

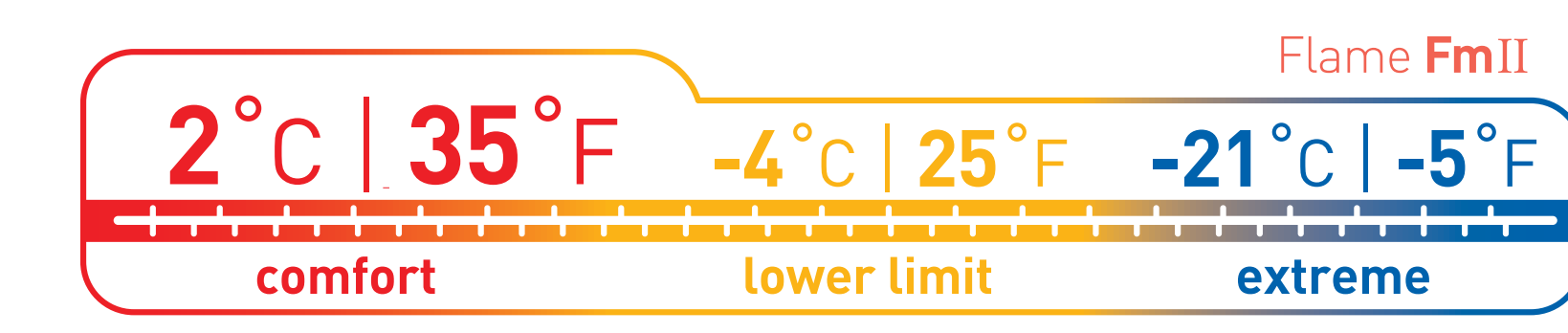
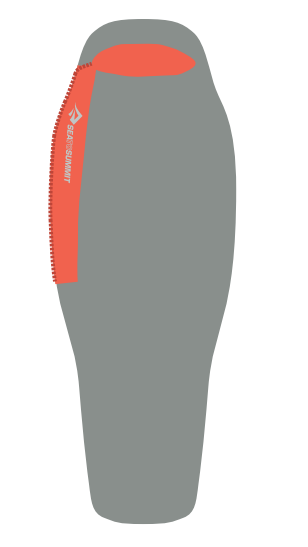

Temperature rated in accordance with EN13537

FmIII

Regular	Long
150cm 59"	155cm 61"
142cm 56"	148cm 58"
90cm 36"	96cm 38"
<183cm 6'	<198cm 6'6"

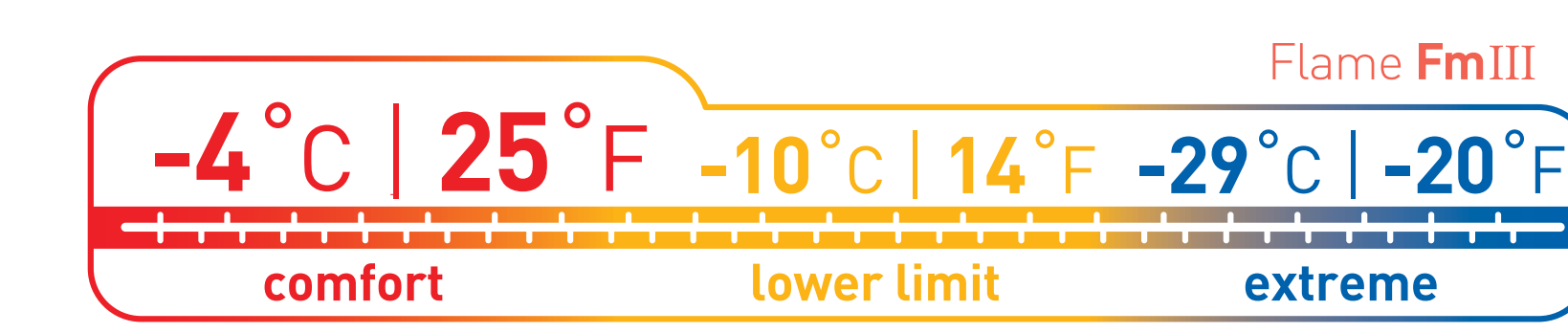
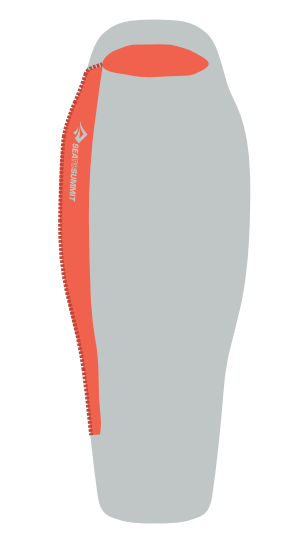

Temperature rated in accordance with EN13537

FmIV

Regular	Long
150cm 59"	155cm 61"
142cm 56"	148cm 58"
90cm 36"	96cm 38"
<183cm 6'	<198cm 6'6"

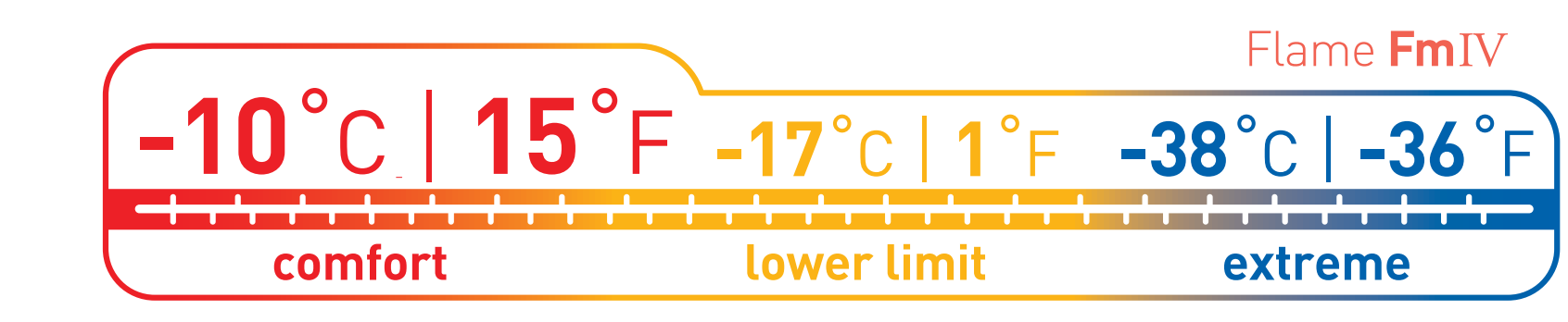
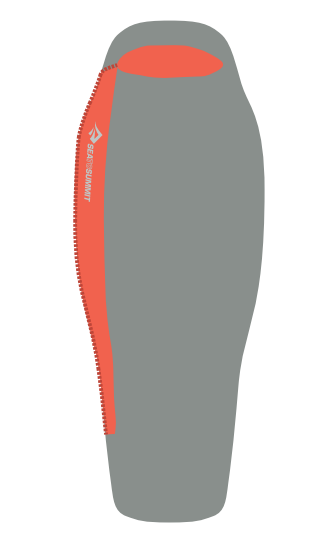

Temperature rated in accordance with EN13537

PRODUCT NAME	CODE	SIZE	WEIGHT	FILL WEIGHT	COMPRESSED SIZE	STORAGE	BAFFLE CONSTRUCTION	RRP
Flame Fm0	AFM0-WR	Regular	215g 7.6 oz	100g 3.5 oz	ø9.5 x 16cm 0.7L	Integrated stuff sack (uncompressed dimensions)	Narrow horizontal baffles, sewn through quilted construction throughout	
	AFM0-WL	Long	250g 8.8 oz	115g 4.1 oz	ø10.5 x 18cm 1.1L			
Flame FmI	AFM1-WR	Regular	350g 12.3 oz	190g 6.7 oz	ø11.5 x 15cm 1.6L	3XS / 2.5L	Vertical chest baffles, horizontal baffles lower half and base, sewn through quilted construction throughout	
	AFM1-WL	Long	395g 13.9 oz	215g 7.6 oz	ø11.5 x 21cm 2.2L			
Flame FmII	AFM2-WR	Regular	505g 17.8 oz	310g 10.9 oz	ø13 x 22cm 2.9L	2XS / 3.3L	Vertical chest baffles, horizontal baffles lower half and base, box wall baffles top half of bag and sewn through quilted	
	AFM2-WL	Long	575g 20.3 oz	355g 12.5 oz	ø15.5 x 20cm 3.8L	XS / 6L		
Flame FmIII	AFM3-WR	Regular	665g 23.5 oz	440g 15.5 oz	ø15.5 x 28cm 5.3L	XS / 6L	Vertical chest baffles, horizontal baffles lower half and base, box wall baffle construction throughout	
	AFM3-WL	Long	745g 26.3 oz	495g 17.5 oz	ø18.5 x 23cm 6.3L	S / 10L		
Flame FmIV	AFM4-WR	Regular	890g 31.4 oz	650g 22.9 oz	ø18.5 x 26cm 7.1L	S / 10L		
	AFM4-WL	Long	995g 35.1 oz	730g 25.7 oz	ø18.5 x 29cm 7.9L			

DESIGNED FOR	Women's specific design
ZIPS	Fm 0-II: Light gauge YKK #3 Fm III-IV: YKK #5
PAIRING	These bags are NOT designed to pair with another
SHAPE	Fm 0-II: Contoured Mummy Fm III-IV: Expedition Mummy
NECK DRAFT TUBE	Sp 0-I: <input type="checkbox"/> Sp II-IV: <input checked="" type="checkbox"/>
SECURITY POCKET	<input type="checkbox"/>



Ascent Ac



Offering the perfect backpacking balance of comfort vs weight, our Ascent Series sleeping bags have more space than traditional mummy bags, yet still provide the thermal efficiency you need when exploring above the tree-line.



Altitude At



Engineered for women to provide extra warmth where needed, be prepared for the unpredictable with our adaptable Altitude Series bags.

ENGINEERED FOR WOMEN





Ascent Ac

Regular

155cm | 61"

146cm | 57"

122cm | 48"

<183cm | 6'



MAX USER HEIGHT

Long

165cm | 65"

156cm | 61"

129cm | 51"

<198cm | 6'6"

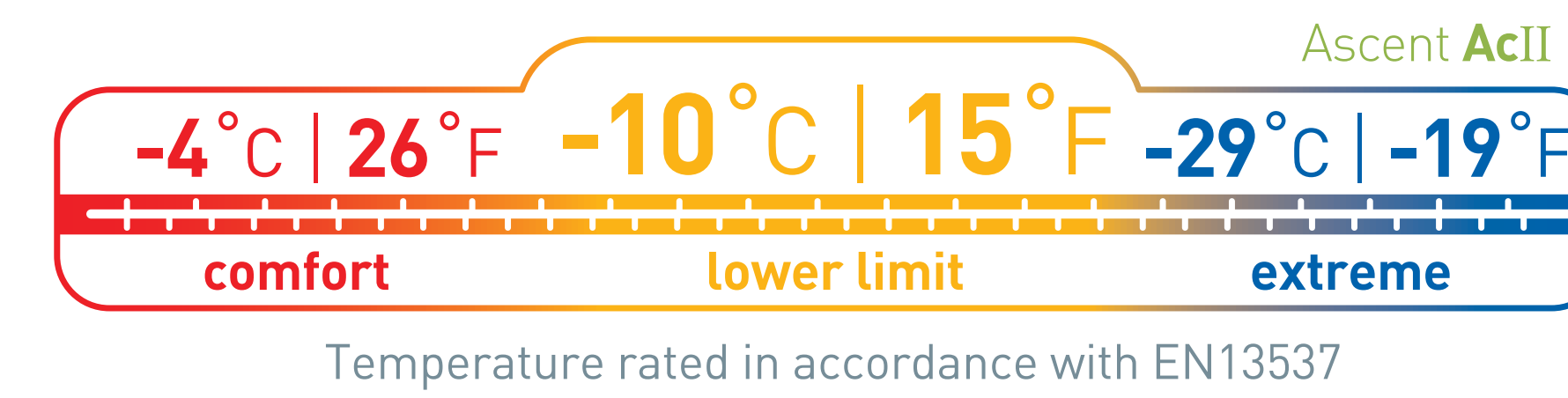
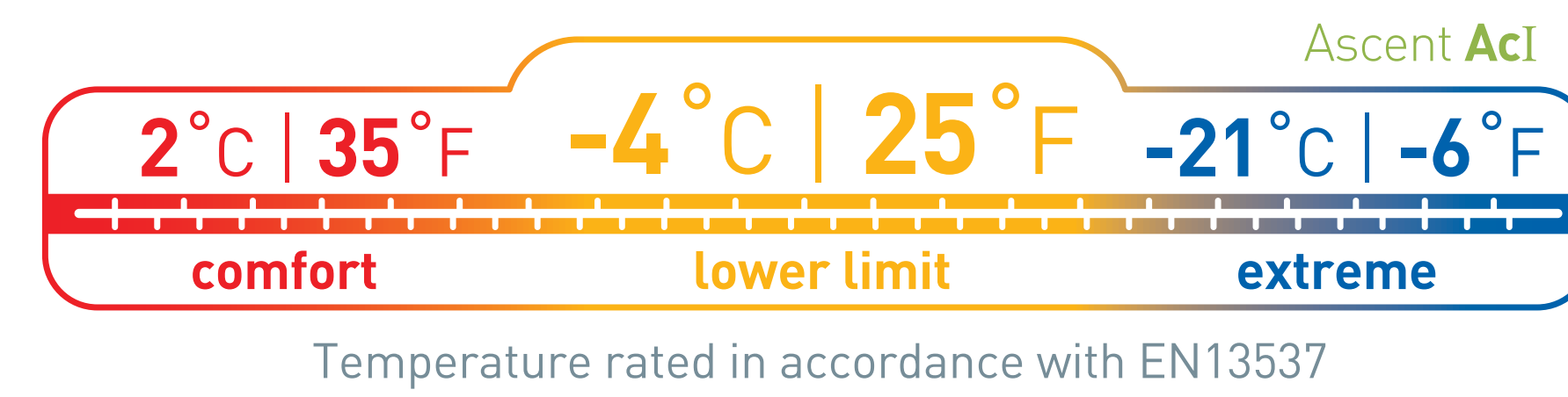

PRODUCT NAME	CODE	SIZE	MAX USER HEIGHT	WEIGHT	FILL WEIGHT	COMPRESSED SIZE	STORAGE	BAFFLE CONSTRUCTION	RRP
Ascent AcI	AAC1-R	Regular	< 183 cm 6'	860g 30.3 oz	330g 11.6 oz	ø18.5 x 18cm 4.9L			
	AAC1-L	Long	< 198 cm 6' 6"	930g 32.8 oz	370g 13.1 oz	ø18.5 x 24cm 6.4L	S / 10L Ultra-Sil Compression		
Ascent AcII	AAC2-R	Regular	< 183 cm 6'	1100g 38.8 oz	550g 19.4 oz	ø18.5 x 23cm 6.2L		Vertical chest baffles, horizontal baffles lower half and base, box wall baffle construction throughout	
	AAC2-L	Long	< 198 cm 6' 6"	1195g 42.2 oz	615g 21.7 oz	ø21 x 23cm 7.8L			
Ascent AcIII	AAC3-R	Regular	< 183 cm 6'	1325g 46.7 oz	750g 26.5 oz	ø21 x 24cm 8.2L	M / 14L Ultra-Sil Compression		
	AAC3-L	Long	< 198 cm 6' 6"	1445g 51 oz	840g 29.6 oz	ø21 x 29cm 10.2L			

DESIGNED FOR Unisex design

ZIPS YKK #5 Double sliders

PAIRING This bag IS designed to pair with another

SHAPE Tapered rectangular

NECK DRAFT TUBE

SECURITY POCKET



Altitude At

Regular

148cm | 58"

148cm | 58"

118cm | 46"

<183cm | 6'

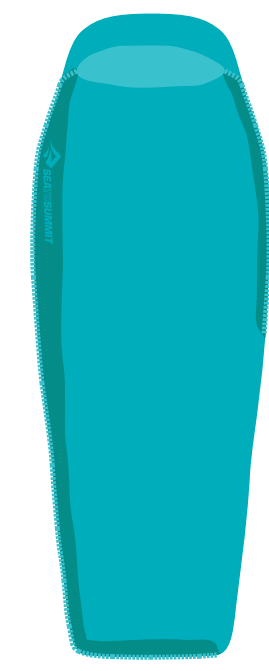

MAX USER HEIGHT

Long

152cm | 60"

152cm | 60"

122cm | 48"

<198cm | 6'6"

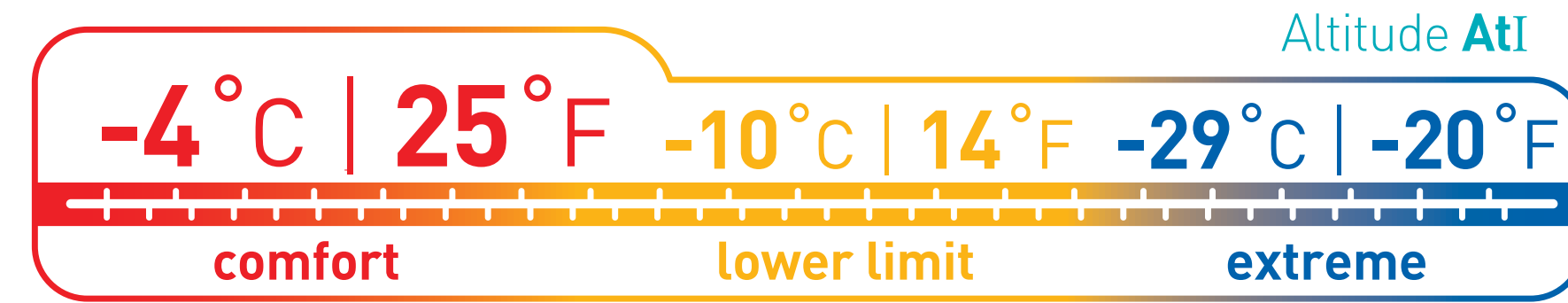

Temperature rated in accordance with EN13537

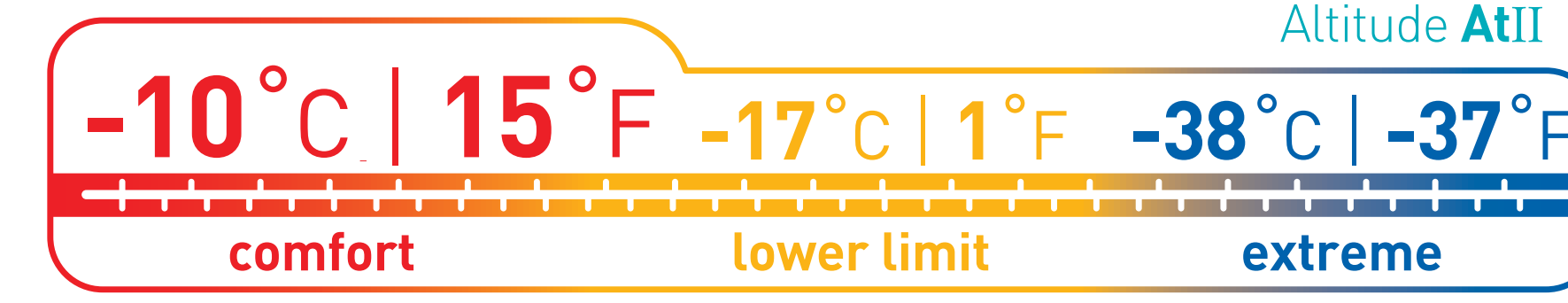

Temperature rated in accordance with EN13537

PRODUCT NAME	CODE	SIZE	MAX USER HEIGHT	WEIGHT	FILL WEIGHT	COMPRESSED SIZE	STORAGE	BAFFLE CONSTRUCTION	RRP
Altitude AtI	AAT1-WR	Regular	< 170 cm 5' 7"	1080g 38.1 oz	520g 18.3 oz	ø18.5 x 24cm 6.5L	S / 10L Ultra-Sil Compression	Vertical chest baffles, horizontal baffles lower half and base, box wall baffle construction throughout	
	AAT1-WL	Long	< 183cm 6'	1170g 41.3 oz	580g 20.5 oz	ø18.5 x 31cm 8.3L			
Altitude AtII	AAT2-WR	Regular	< 170 cm 5' 7"	1280g 45.1 oz	720g 25.4 oz	ø21 x 23cm 8.1L	M / 14L Ultra-Sil Compression		
	AAT2-WL	Long	< 183cm 6'	1390g 49 oz	800g 28.2 oz	ø21 x 28cm 9.8L			

DESIGNED FOR Women's specific design

FEATURES Extra down overall, THERMOLITE® panels in foot area

ZIPS YKK #5 Double sliders

PAIRING This bag IS designed to pair with another

SHAPE Tapered rectangular

NECK DRAFT TUBE

SECURITY POCKET



Amplitude Am



Comfort and versatility for long trips when shaving weight is not your highest priority.

The Amplitude is ideal for outdoor adventures that return to the same camp site each evening, for car camping road trips, crag-hopping van life or hut-based expeditions.



Traveller Tr



Small and light yet warm and lofty 750+ down, the Traveller is your couch-surfing comrade.

The ultimate choice for your Camino pilgrimage, round-the-world adventure or keeping warm on a plane.





Amplitude Am

Regular	Long	Double
194cm 76"	208cm 82"	326cm 128"
190cm 75"	204cm 80"	319cm 126"
142cm 56"	172cm 68"	282cm 111"
<183cm 6'	<198cm 6'6"	<183cm 6'

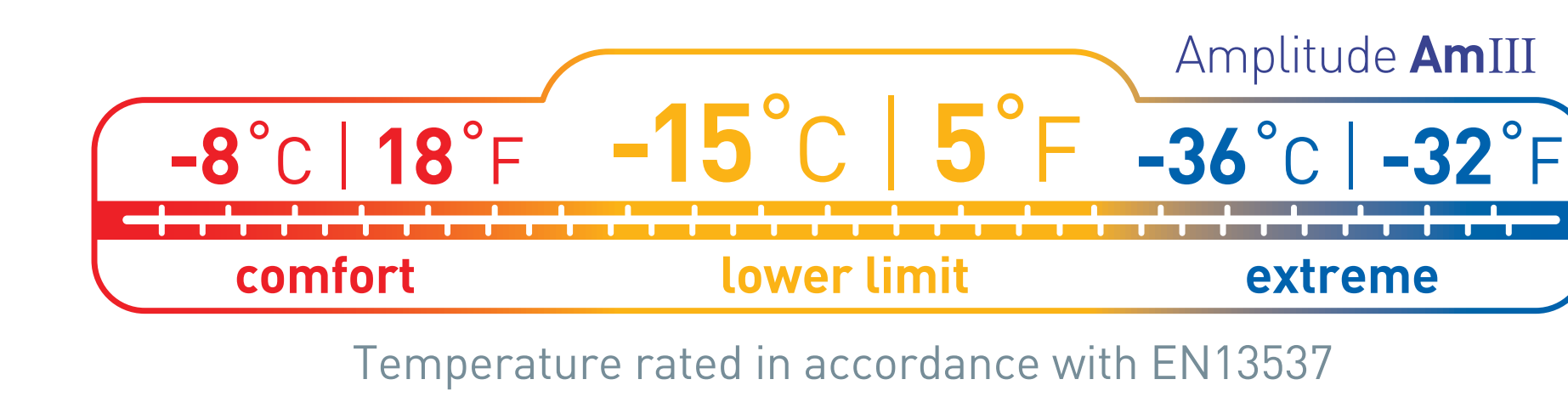
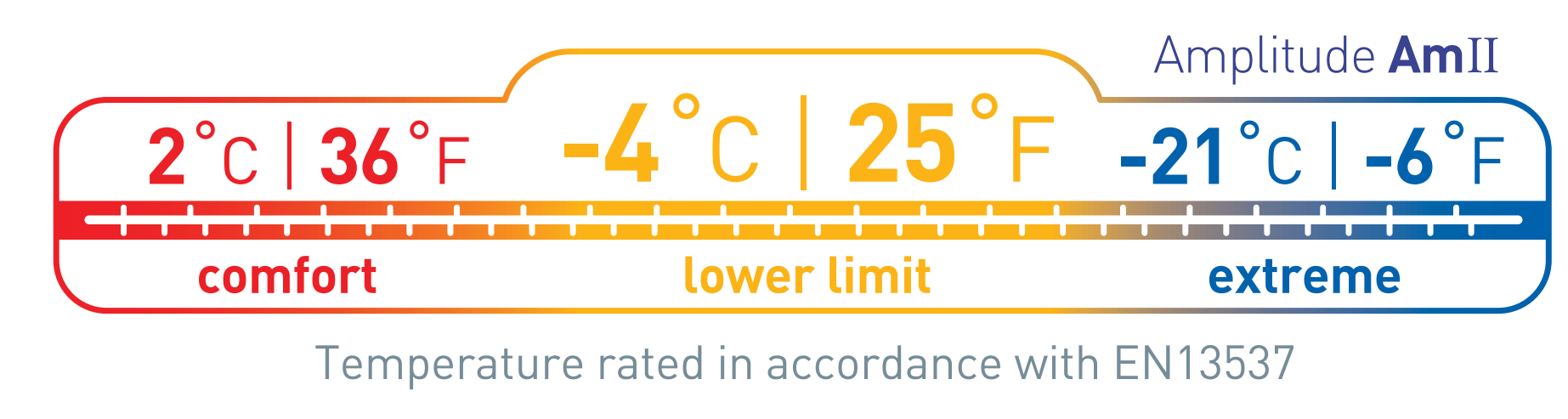
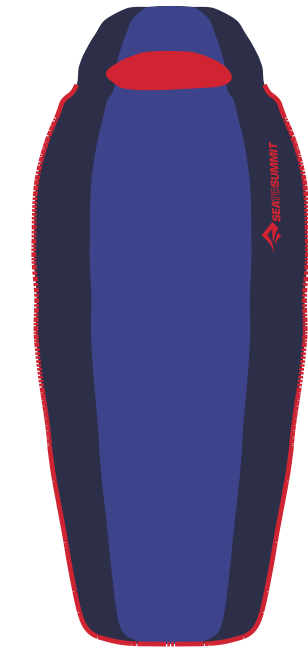

PRODUCT NAME	CODE	SIZE	MAX USER HEIGHT	WEIGHT	FILL WEIGHT	COMPRESSED SIZE	STORAGE	BAFFLE CONSTRUCTION	RRP
Amplitude AmII	AMP2-R	Regular	< 183 cm 6'	1095g 38.6 oz	450g 15.9 oz	ø18.5 x 23cm 6.3L	S / 10L	Vertical chest baffles, horizontal baffles lower half and base, box wall baffle construction throughout	
	AMP2-L	Long	< 198 cm 6' 6"	1205g 42.5 oz	520g 18.3 oz	ø18.5 x 30cm 8L			
Amplitude AmIII	AMP3-R	Regular	< 183 cm 6'	1395g 49.2 oz	750g 26.5 oz	ø21 x 30cm 10.4L	M / 14L		
	AMP3-L	Long	< 198 cm 6' 6"	1595g 56.3 oz	860g 30.3 oz	ø21 x 36cm 12.3L			
	AMP3-D	Double	< 183 cm 6'	1780g 62.8 oz	1000g 35.3 oz	ø24 x 31cm 14L			

- DESIGNED FOR: Unisex design
- ZIPS: Full length YKK #5 side zips with two sliders on both sides of bag. YKK #5 foot opening zip
- MULTI-ZIP: Multi-zip configuration converts bag to a standalone quilt for warmer conditions
- PAIRING: This bag IS designed to pair with another
- FEATURES: Adjustable webbing loop system connects sleeping mat to bag
- SHAPE: Spacious contoured rectangle
- NECK DRAFT TUBE:
- SECURITY POCKET:



Traveller Tr

TrI

Regular

148cm | 58"
134cm | 53"
98cm | 39"
<183cm | 6'
MAX USER HEIGHT

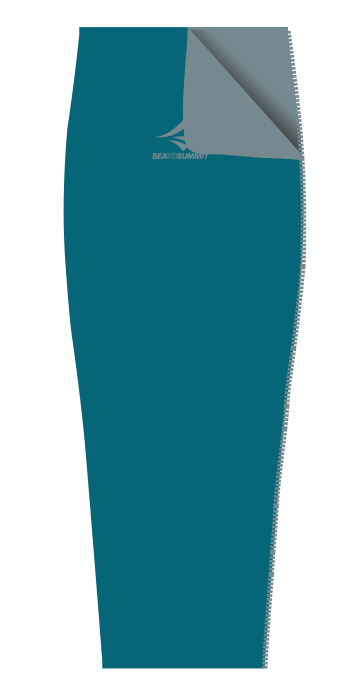

Long

168cm | 66"
154cm | 61"
118cm | 46"
<198cm | 6'6"
MAX USER HEIGHT

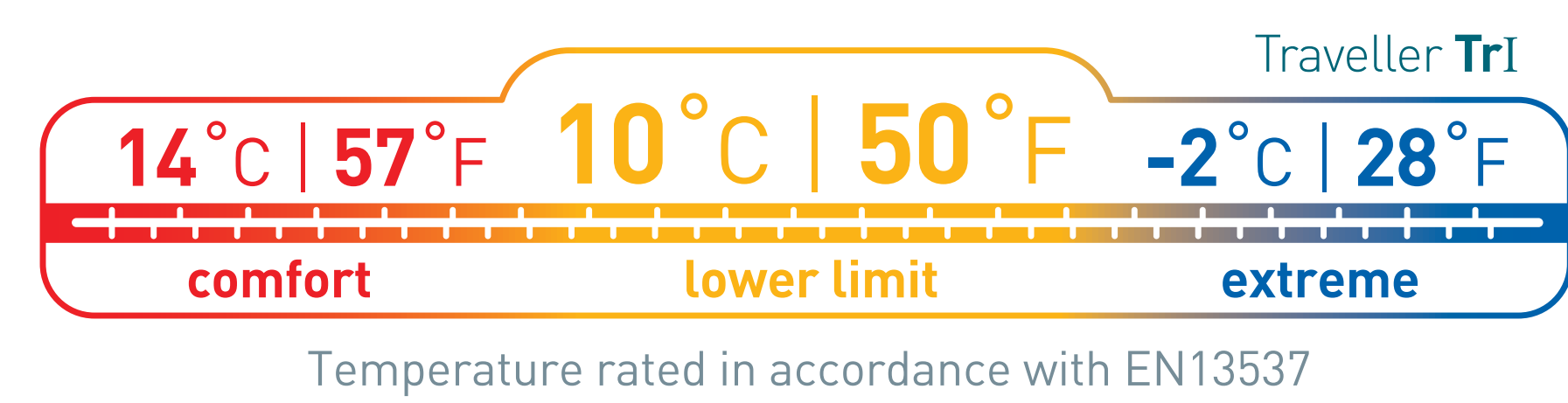

TrII

Regular

155cm | 61"
141cm | 55"
105cm | 41"
<183cm | 6'
MAX USER HEIGHT

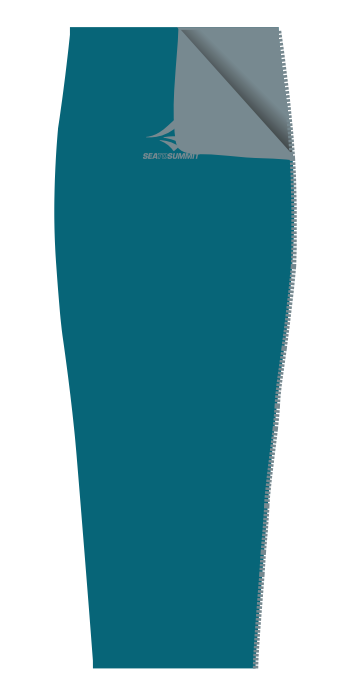

Long

168cm | 66"
154cm | 61"
118cm | 46"
<198cm | 6'6"
MAX USER HEIGHT

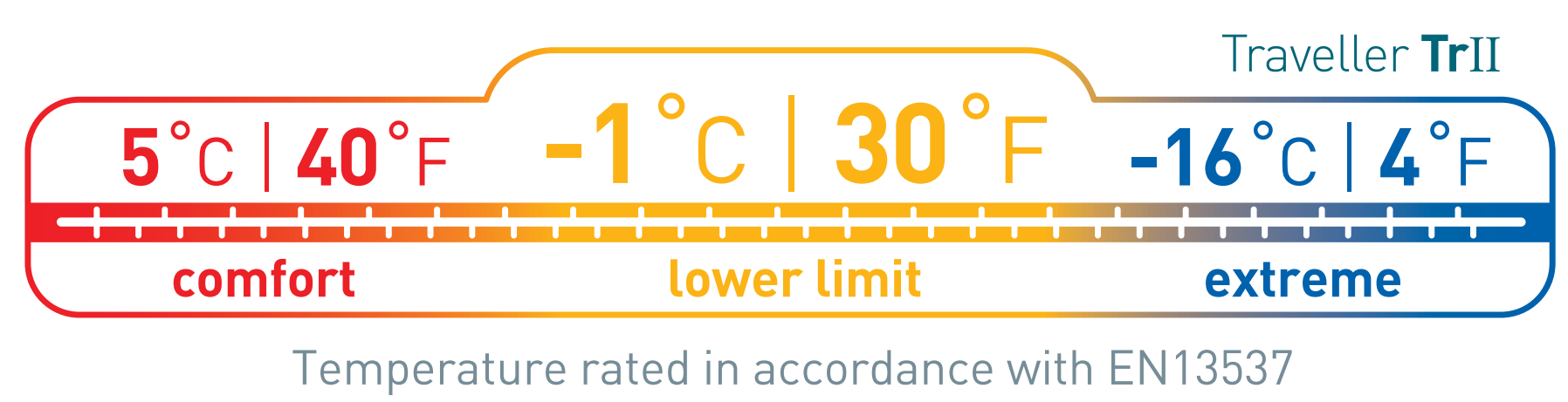

PRODUCT NAME	CODE	SIZE	MAX USER HEIGHT	WEIGHT	FILL WEIGHT	COMPRESSED SIZE	STORAGE	BAFFLE CONSTRUCTION	RRP
Traveller TrI	ATR1-R	Regular	< 183 cm 6'	420g 14.8 oz	200g 7.1 oz	ø11.5 x 15cm 1.6L	3XS / 2.5L	Box quilted sewn through baffles	
	ATR1-L	Long	< 198 cm 6' 6"	500g 17.6 oz	240g 8.5 oz	ø13 x 18cm 2.4L	2XS / 3.3L		
Traveller TrII	ATR2-R	Regular	< 183 cm 6'	645g 22.8 oz	350g 12.3 oz	ø15.5 x 24cm 4.5L	XS / 6L	Narrow horizontal box wall baffles	
	ATR2-L	Long	< 198 cm 6' 6"	755g 26.6 oz	420g 14.8 oz	ø18 x 23cm 5.8L	S / 10L		

- DESIGNED FOR** Unisex design
- ZIPS** Full length YKK #3 side zip, two sliders
- PAIRING** This bag IS designed to pair ONLY with another Traveller
- SHAPE** Tapered rectangular / quilt
- FEATURES** Shoulder and foot drawcords cinch the bag tight to retain maximum warmth
- NECK DRAFT TUBE**
- SECURITY POCKET**



Trek Tk



Comfort, versatility and value in a classic tapered rectangular down bag.

Traditional comfort and value, with an anything but traditional design approach, the Trek Series sleeping bags are what we grab for globe-trotting adventures on a budget.



Journey Jo



Engineered for women to provide extra warmth where needed in a classic tapered rectangular down bag for comfort, versatility and value.

Our Journey Series sleeping bags are what we grab for globe-trotting adventures on a budget.

ENGINEERED FOR WOMEN





Trek Tk

Regular	Reg Wide	Long
152cm 60"	172cm 68"	162cm 64"
146cm 57"	161cm 63"	157cm 62"
102cm 40"	122cm 48"	108cm 43"
<183cm 6'	<183cm 6'	<198cm 6'6"



MAX USER HEIGHT

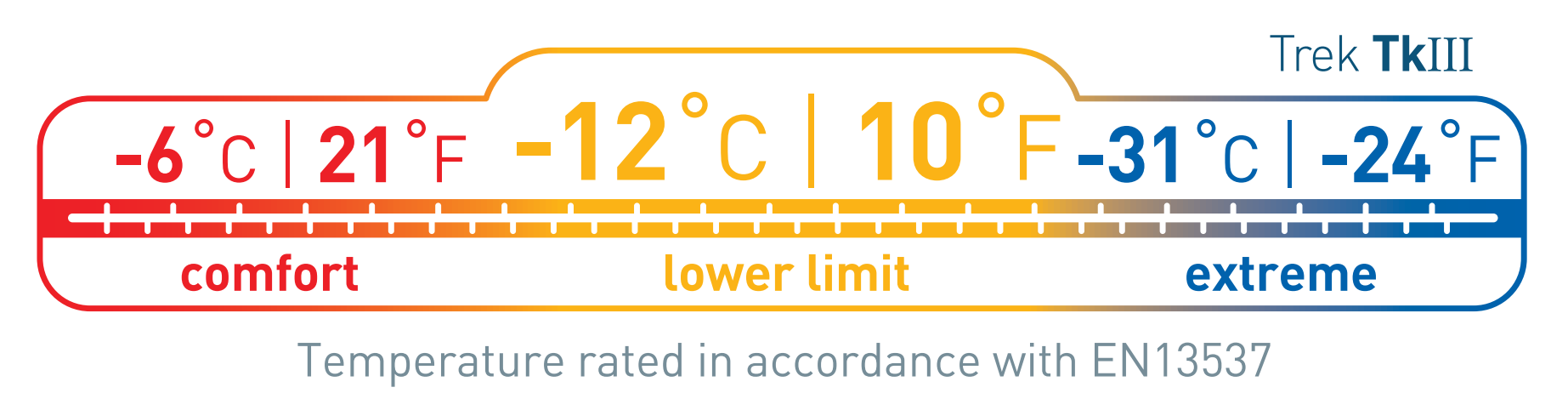
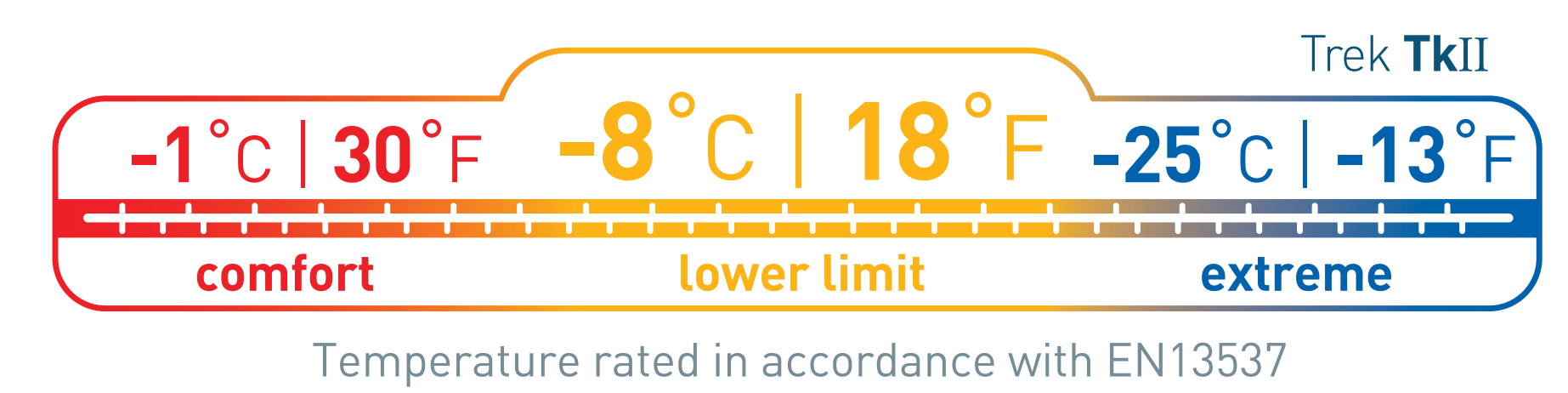
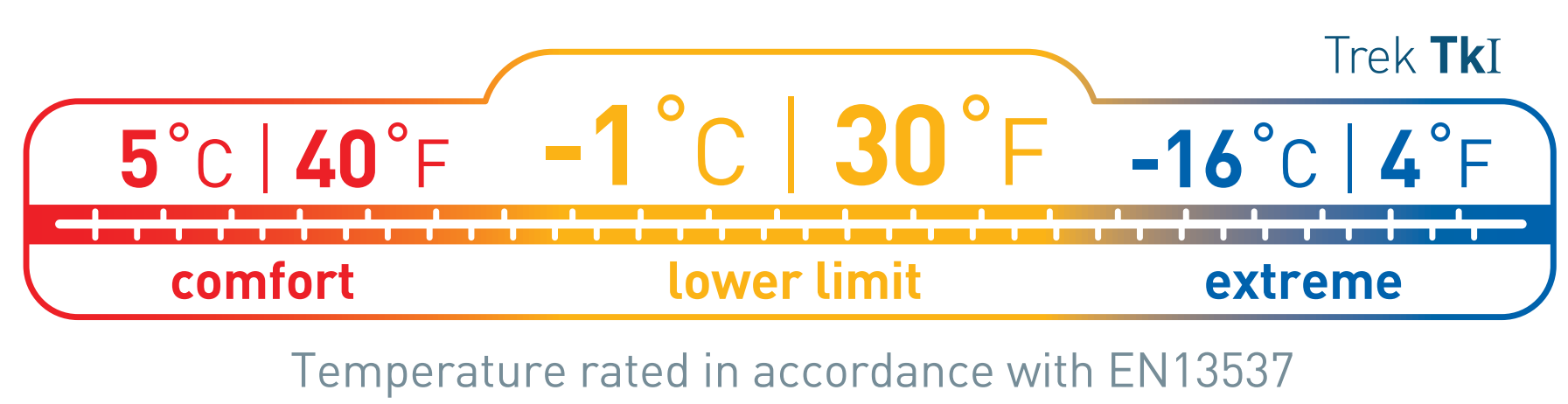

PRODUCT NAME	CODE	SIZE	MAX USER HEIGHT	WEIGHT	FILL WEIGHT	COMPRESSED SIZE	STORAGE	BAFFLE CONSTRUCTION	RRP
Trek TkI	ATK1-R	Regular	< 183 cm 6'	760g 26.8 oz	350g 12.3 oz	ø18.5 x 17cm 4.6L	S / 10L	Vertical chest baffles, horizontal baffles lower half and base, box wall baffle construction on top and sewn through on base	
	ATK1-RW	Regular Wide		920g 32.5 oz	450g 15.9 oz	ø18.5 x 23cm 6.2L			
	ATK1-L	Long	< 198 cm 6' 6"	850g 30 oz	400g 14.1 oz	ø18.5 x 21cm 5.5L			
Trek TkII	ATK2-R	Regular	< 183 cm 6'	980g 34.6 oz	500g 17.6 oz	ø18.5 x 23cm 6.1L	M / 14L	Vertical chest baffles, horizontal baffles lower half and base, box wall baffle construction throughout	
	ATK2-RW	Regular Wide		1160g 40.9 oz	600g 21.2 oz	ø21 x 21cm 7.4L			
	ATK2-L	Long	< 198 cm 6' 6"	1080g 38.1 oz	560g 19.8 oz	ø21 x 21cm 7.3L			
Trek TkIII	ATK3-R	Regular	< 183 cm 6'	1190g 42 oz	700g 24.7 oz	ø21 x 24cm 8.4L			
	ATK3-L	Long	< 198 cm 6' 6"	1310g 46.2 oz	780g 27.5 oz	ø21 x 29cm 10L			

- DESIGNED FOR** Unisex design
- ZIPS** Full length YKK #5 side zip, two sliders. YKK #5 foot opening zip
- PAIRING** This bag IS designed to pair with another
- SHAPE** Tapered rectangular
- FEATURES** Full length zipper provides maximum versatility, including the option to use as a quilt in warmer conditions
- NECK DRAFT TUBE** TkI-II: TkIII:
- SECURITY POCKET**



Journey Jo

Regular

148cm | 58"

148cm | 58"

118cm | 46"

<183cm | 6'

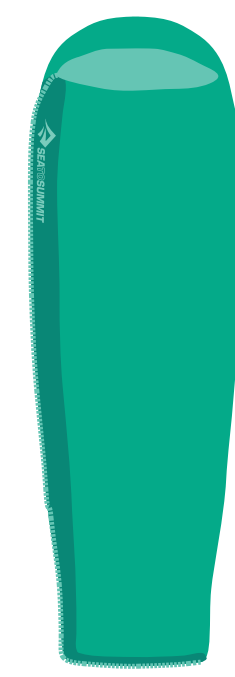

MAX USER HEIGHT

Long

152cm | 60"

152cm | 60"

122cm | 48"

<198cm | 6'6"

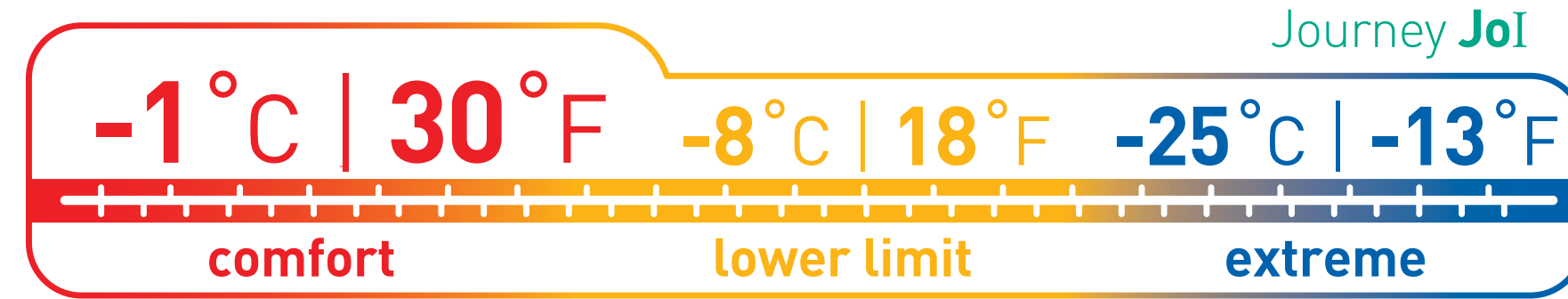

Temperature rated in accordance with EN13537

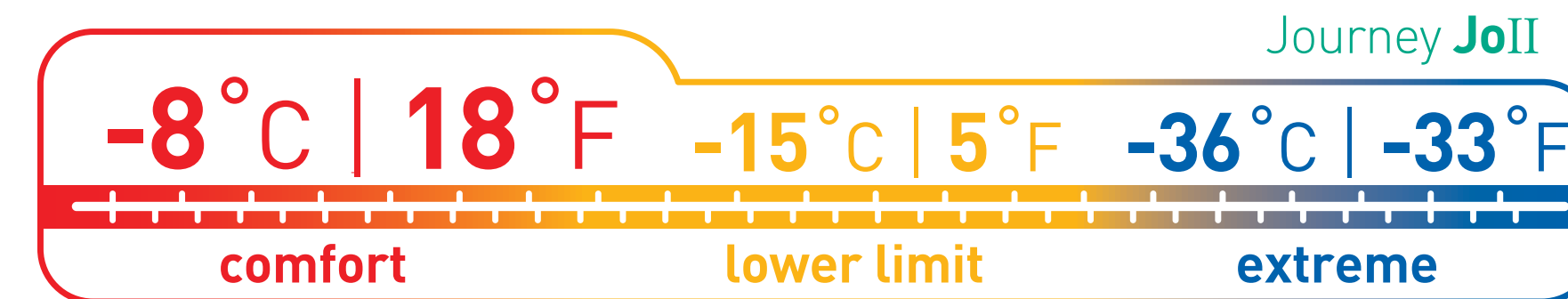

Temperature rated in accordance with EN13537



PRODUCT NAME	CODE	SIZE	MAX USER HEIGHT	WEIGHT	FILL WEIGHT	COMPRESSED SIZE	STORAGE	BAFFLE CONSTRUCTION	RRP
Journey JoI	AJ01-WR	Regular	< 170 cm 5' 7"	960g 33.9 oz	500g 17.6 oz	ø18.5 x 23cm 6.2L	S / 10L	Vertical chest baffles, horizontal baffles lower half and base, box wall baffle construction throughout	
	AJ01-WL	Long	< 183cm 6'	1050g 37 oz	560g 19.8 oz	ø18.5 x 28cm 7.4L			
Journey JoII	AJ02-WR	Regular	< 170 cm 5' 7"	1180g 41.6 oz	700g 24.7 oz	ø21 x 24cm 8.4L	M / 14L		
	AJ02-WL	Long	< 183cm 6'	1290g 45.5 oz	780g 27.5 oz	ø21 x 29cm 9.9L			

DESIGNED FOR Women's specific design

FEATURES Extra down overall THERMOLITE® panels in foot area

ZIPS Full length YKK #5 side zip, two sliders. YKK #5 foot opening zip

ZIPS Unzips to allow use as a quilt in warmer conditions

PAIRING This bag IS designed to pair with another

SHAPE Tapered rectangular

NECK DRAFT TUBE JoI: JoII:

SECURITY POCKET



Treeline TL



Simple and durable, yet refined, this bag is your perfect companion for uncomplicated summer adventures.

While we've given this design a little extra room around the shoulders and hips for freedom of movement, the relaxed mummy shape still provides efficient warmth and heat retention when you need it.

 **ZIP COUPLING**
BAGS ZIP TOGETHER

 **600+ Loft**

 VIDEO





Treeline TL

Regular

155cm | 61"

136cm | 54"

103cm | 41"

<183cm | 6'



MAX USER HEIGHT

Long

165cm | 65"

143cm | 56"

107cm | 42"

<198cm | 6'6"



PRODUCT NAME	CODE	SIZE	MAX USER HEIGHT	WEIGHT	FILL WEIGHT	COMPRESSED SIZE	STORAGE	BAFFLE CONSTRUCTION	RRP
Treeline TL	ATL1-R	Regular	< 183 cm 6'	970g 34.2 oz	400g 14.1 oz	5.4L	M / 14L	Horizontal baffles, box wall baffle construction throughout	
	ATL1-L	Long	< 198 cm 6' 6"	1120g 39.5 oz	450g 15.9 oz	6.1L			

- DESIGNED FOR: Unisex design
- ZIPS: Full length YKK #5 side zip, two sliders.
- PAIRING: This bag IS designed to pair with another
- SHAPE: Relaxed mummy
- NECK DRAFT TUBE:
- SECURITY POCKET:



SYNTHETIC SLEEPING BAGS

Boasting all of the details that make our range of Down Sleeping Bags supremely comfortable—our range of technical, synthetic filled bags provide insulation even in the wettest of conditions.

Synthetic bags are also easy to launder and tough enough to withstand camping out of cars with dogs and kids.

Our synthetic bags are lighter, warmer, more technical and designed to be the best on the market.



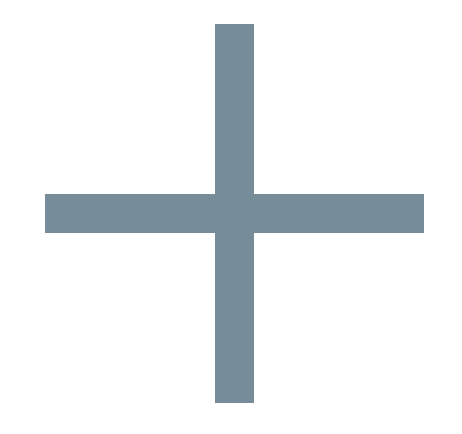

OUR SYNTHETIC SLEEPING BAGS FEATURE:



WAVE LOFT CONSTRUCTION

WaveLoft construction uses thick layers of synthetic insulation looped together to gain extra loft and trap extra pockets of warm air for superior insulation.



THERMOLITE®

THERMOLITE INSULATION

On our high-end bags we use a proprietary blend of THERMOLITE branded insulation, where fine denier hollow-core fibres provide higher loft and superior compressibility.

SECURED LINING FABRIC

Lining fabric is secured to both the insulation and the shell to keep it secure, and to prevent the feeling of getting caught in a loose lining fabric.

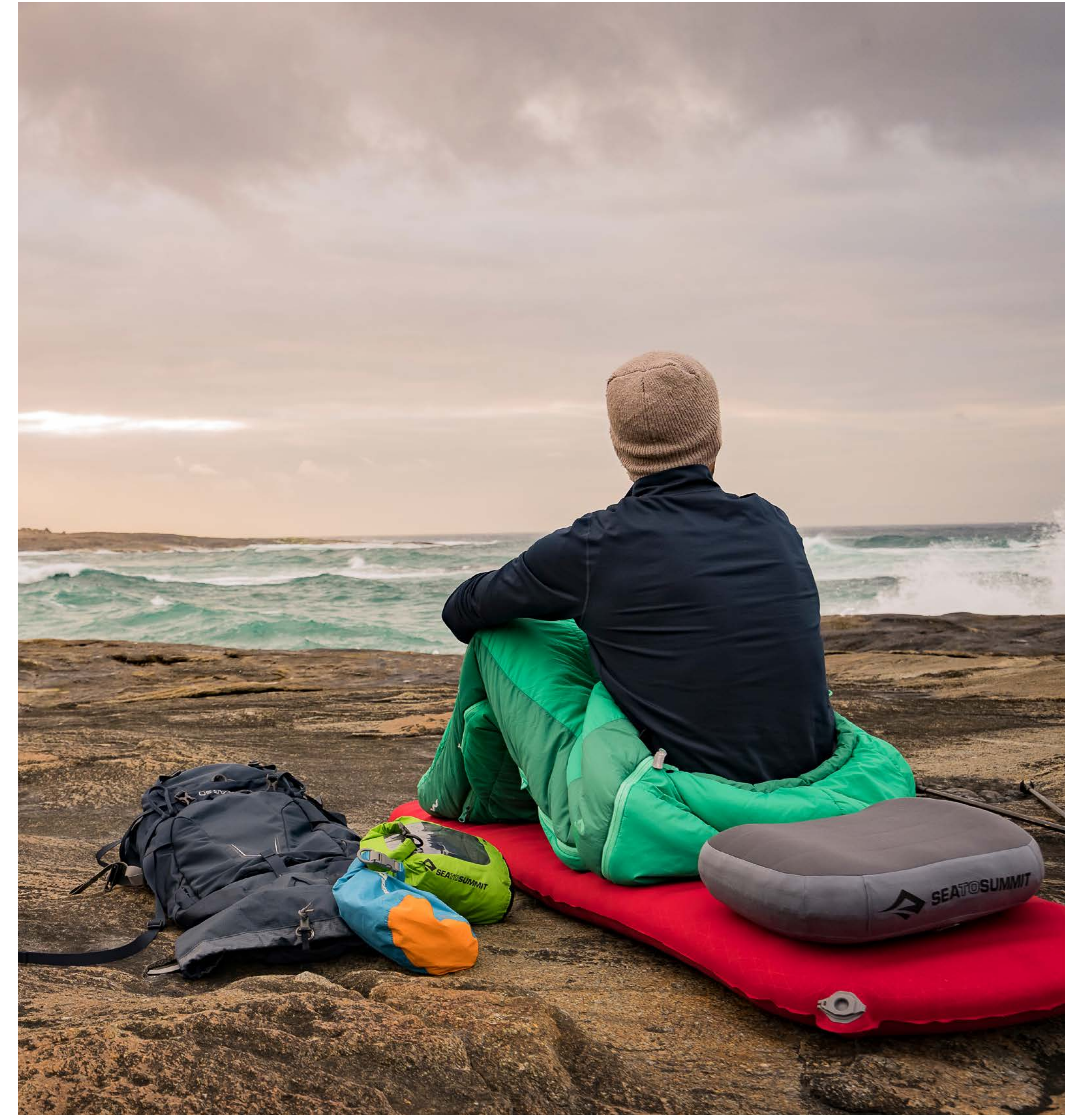



EXPLORE THE RANGE – SYNTHETIC BAGS

THERMOLITE®

SYNTHETIC INSULATION

Basecamp **Bc**



Traverse **Tv**



Venture **Vt**



Trailhead **Th**



Quest **Qu**

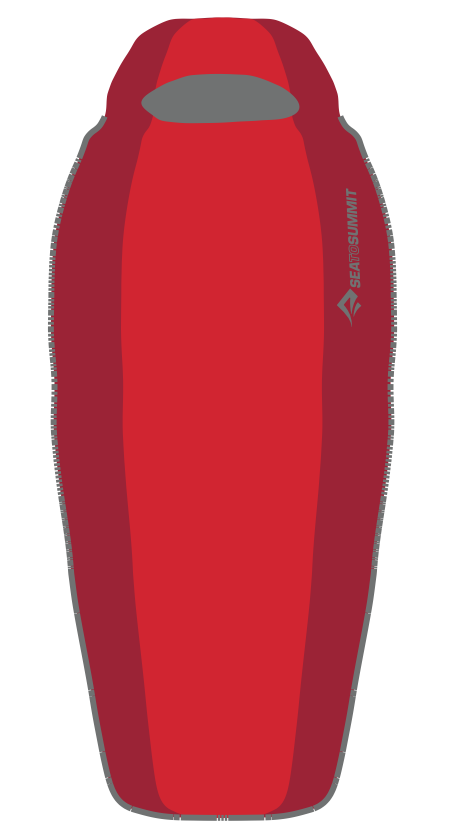

BcII
-7C | 20F

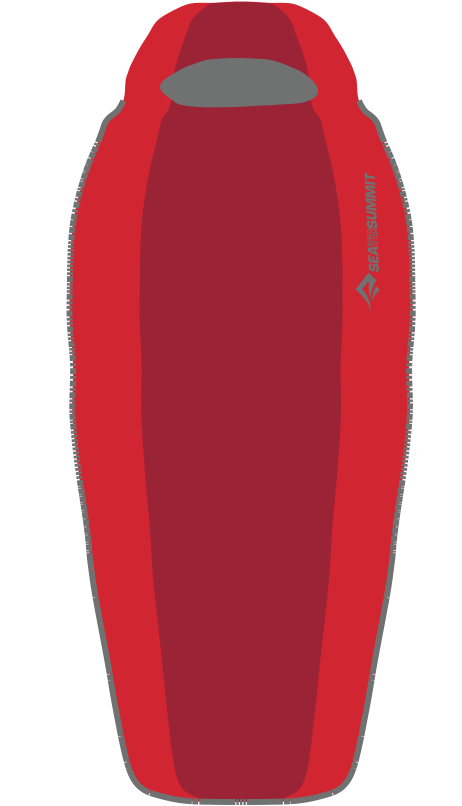

BcIII
-12C | 10F

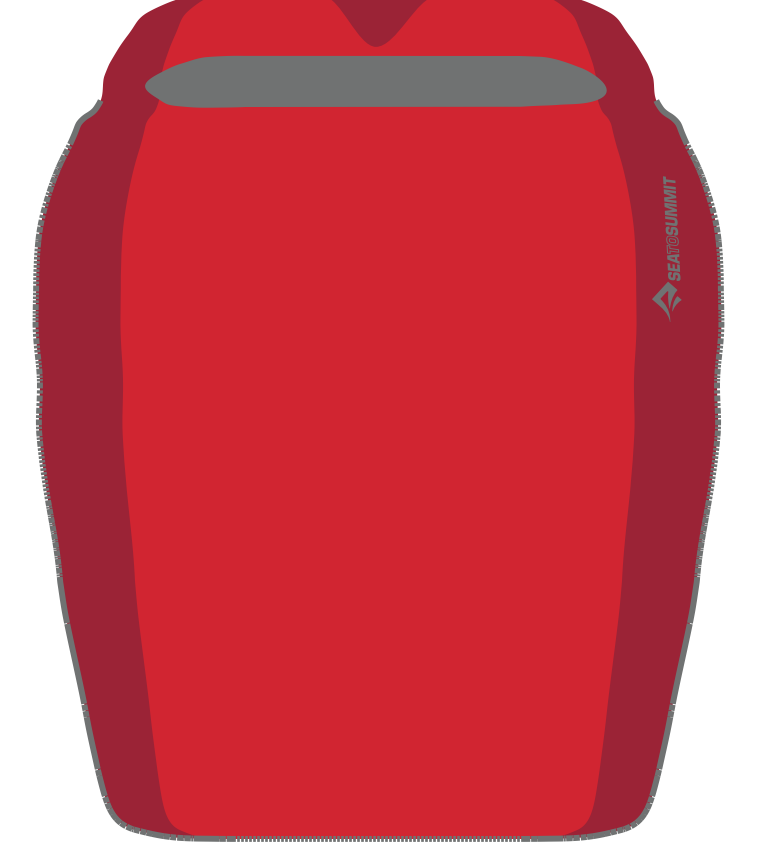

BcII double
-7C | 20F



TvII
-4C | 25F



TvIII
-10C | 14F

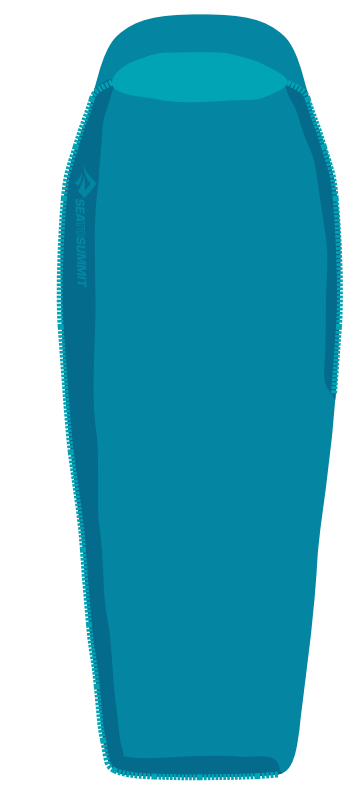

VtII
0C | 32F

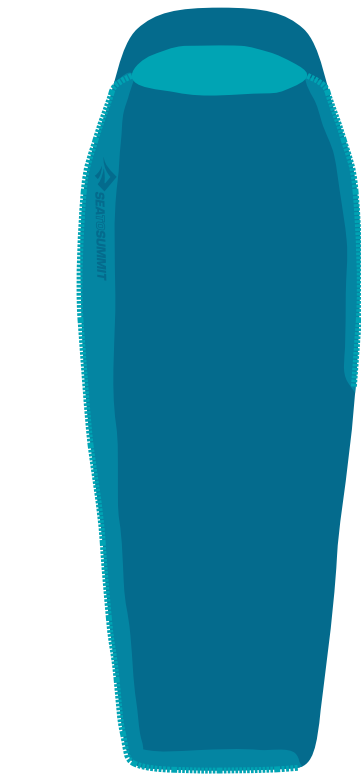

VtIII
-5C | 23F

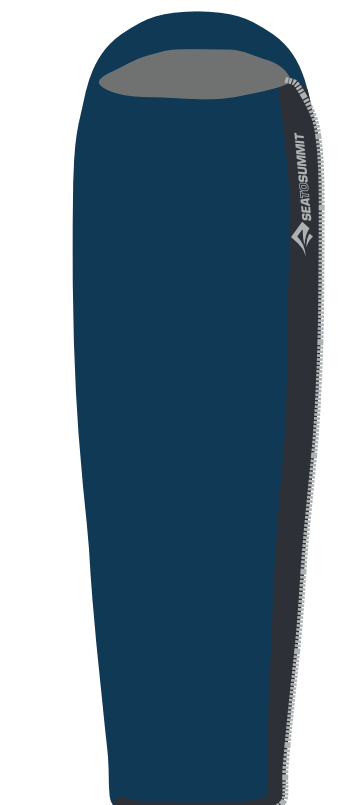

ThII
-1C | 30F

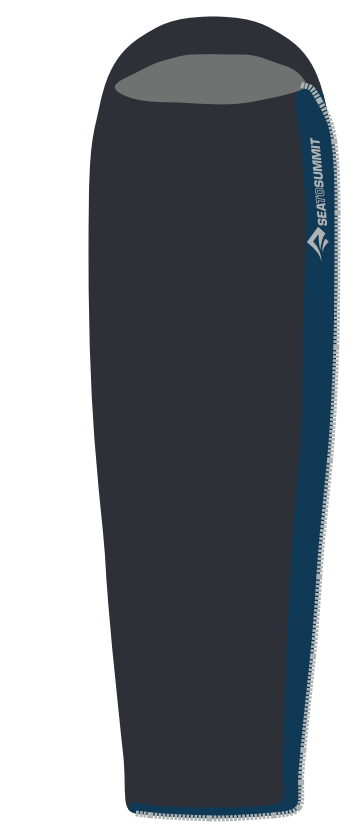

ThIII
-7C | 20F

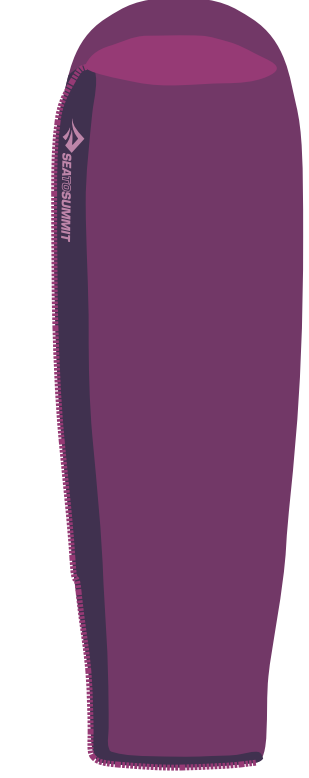

QuI
3C | 37F

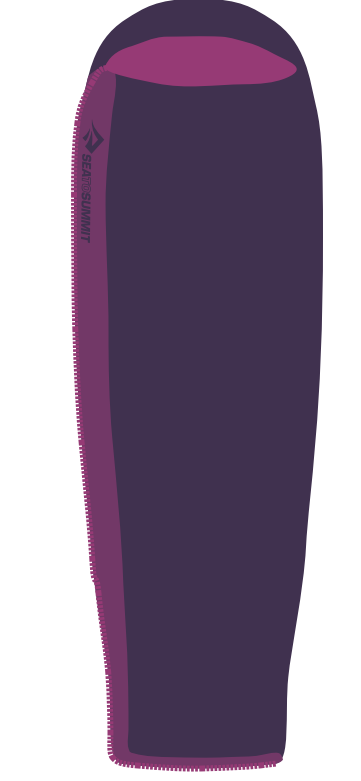

QuII
-1C | 30F



Basecamp BC



Ultra-spacious with multiple ventilation configurations, our Basecamp is pure outdoor luxury.





Basecamp Bc

Regular	Long	Double
194cm 76"	208cm 82"	334cm 132"
190cm 75"	204cm 80"	326cm 128"
142cm 56"	172cm 68"	294cm 116"
<183cm 6'	<198cm 6'6"	<183cm 6'

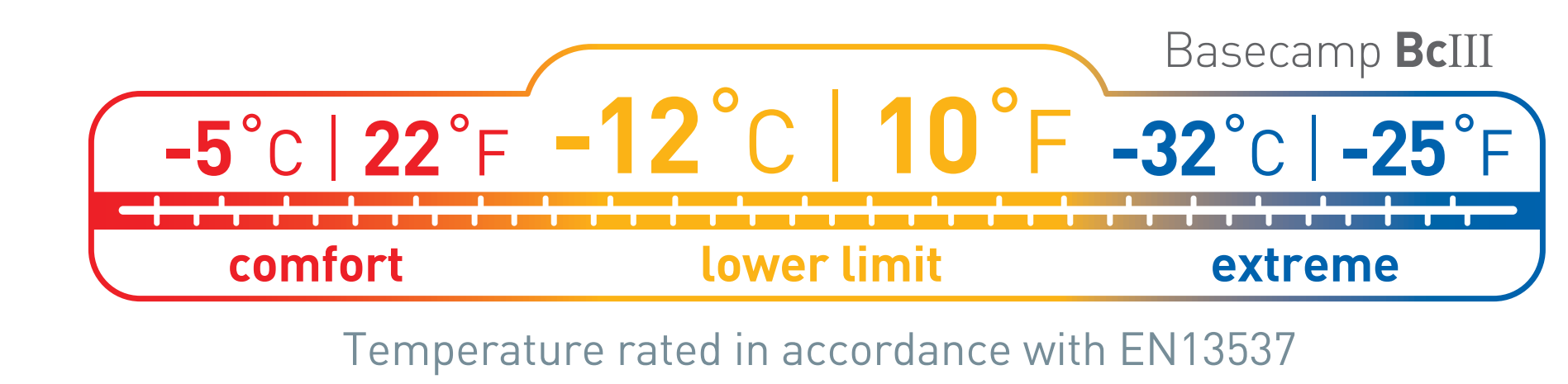
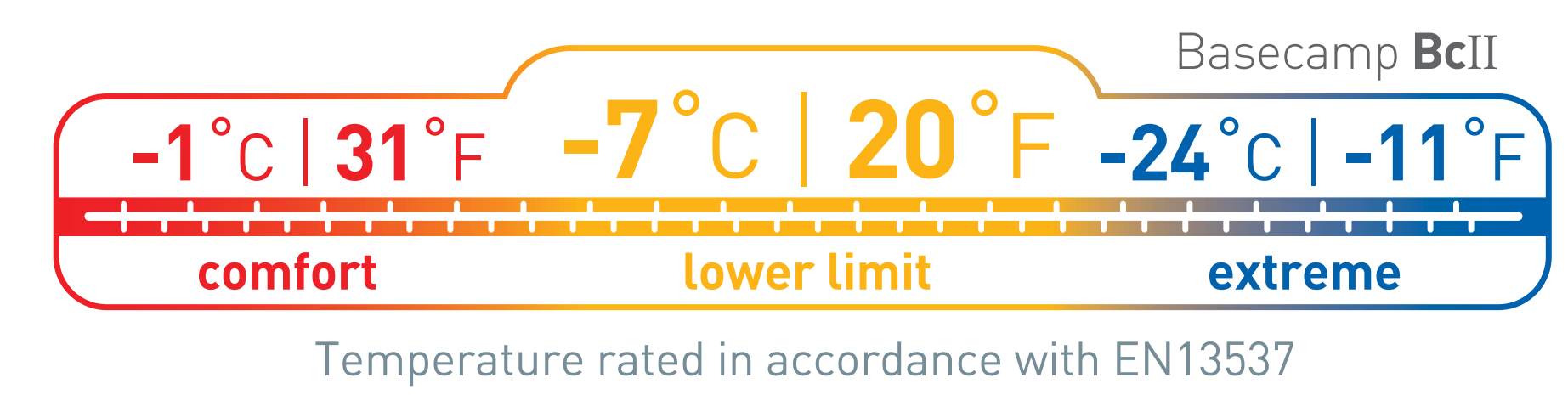
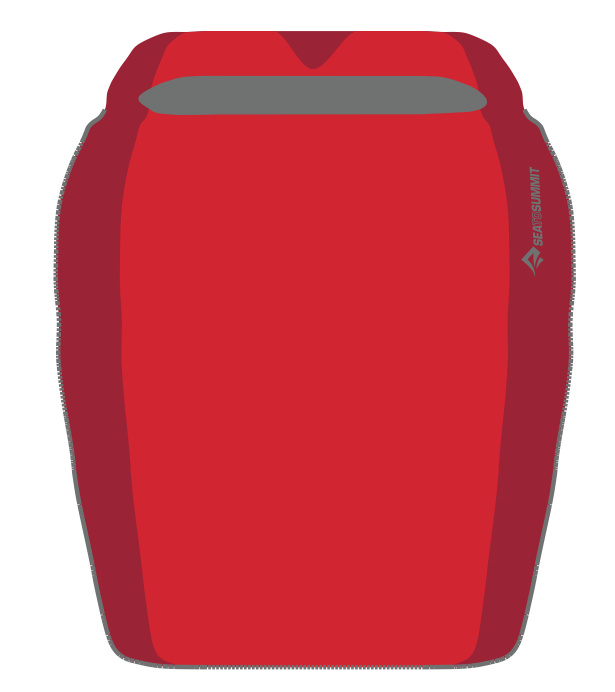
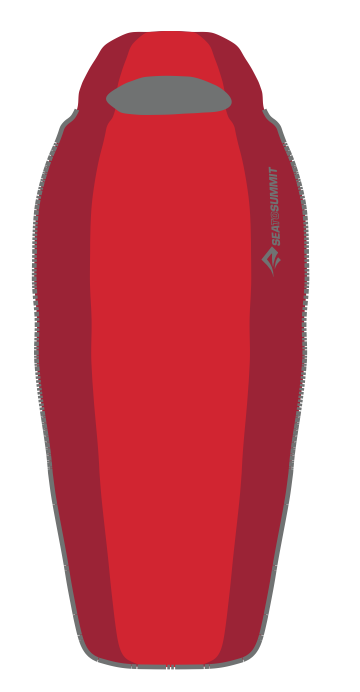

PRODUCT NAME	CODE	SIZE	MAX USER HEIGHT	WEIGHT	COMPRESSED SIZE	STORAGE	BAFFLE CONSTRUCTION	RRP
Basecamp BcII	ABC2-R	Regular	< 183 cm 6'	1340g 47.3 oz	ø21 x 25cm 8.8L	M / 14L		
	ABC2-L	Long	< 198 cm 6' 6"	1600g 56.4 oz	ø21 x 32cm 10.9L			
	ABC2-D	Double	< 183 cm 6'	2300g 81.1 oz	ø27 x 29cm 16.4L	XL / 30L	WaveLoft construction	
Basecamp BcIII	ABC3-R	Regular		1740g 61.4 oz	ø24 x 27cm 12.1L	L / 20L		
	ABC3-L	Long	< 198 cm 6' 6"	2080g 73.4 oz	ø24 x 35cm 16.0L			

- DESIGNED FOR** Unisex design
- ZIPS** Full length YKK #5 side zip, two sliders on both sides of bag. YKK #5 foot opening zip.
- PAIRING** This bag IS designed to pair with another
- FEATURES** Elastic loops connect sleeping bag to mat
- SHAPE** Spacious contoured rectangle
- NECK DRAFT TUBE**
- SECURITY POCKET**



Traverse Tv



A robust and technical synthetic bag, our Traverse provides versatility to stay comfortable in most conditions.

Whether you hike through snow to sleep in an alpine hut or camp out after a summer storm, the Traverse won't let you down.



Venture Vt



Engineered for women to provide extra warmth where needed, our Venture provides synthetic versatility to stay comfortable in most conditions.

Whether you hike through snow to sleep in an alpine hut or camp out after a summer storm, the Venture won't let you down.

ENGINEERED FOR WOMEN





Traverse Tv

Regular

155cm | 61"
146cm | 57"
122cm | 48"
<183cm | 6'

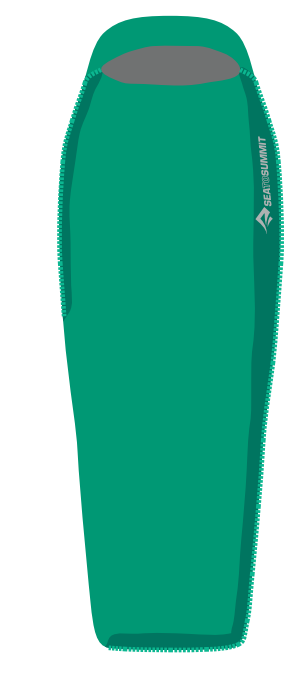

MAX USER HEIGHT

Long

165cm | 65"
156cm | 61"
129cm | 51"
<198cm | 6'6"

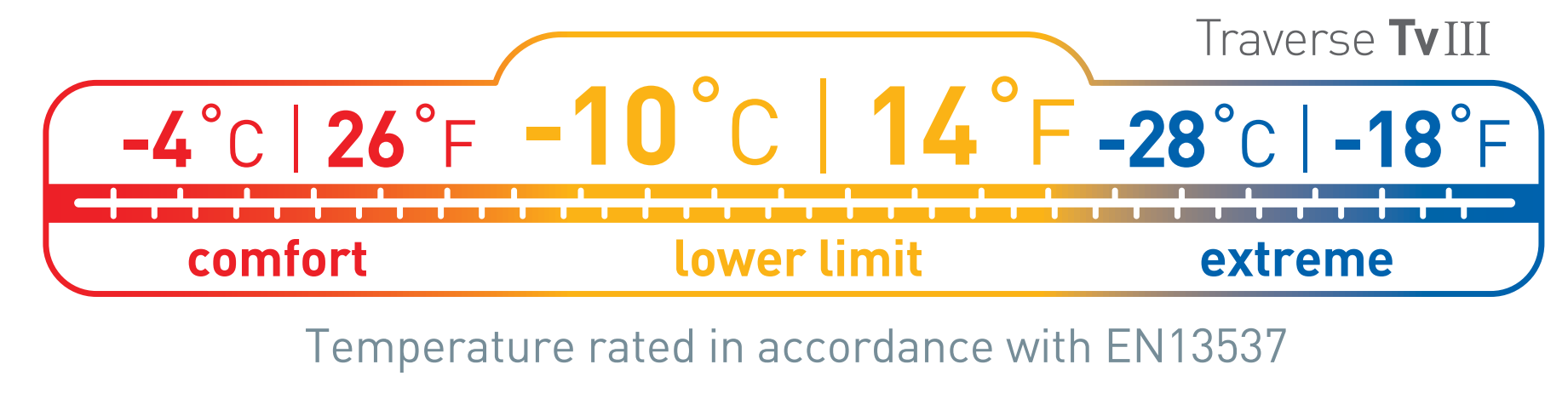
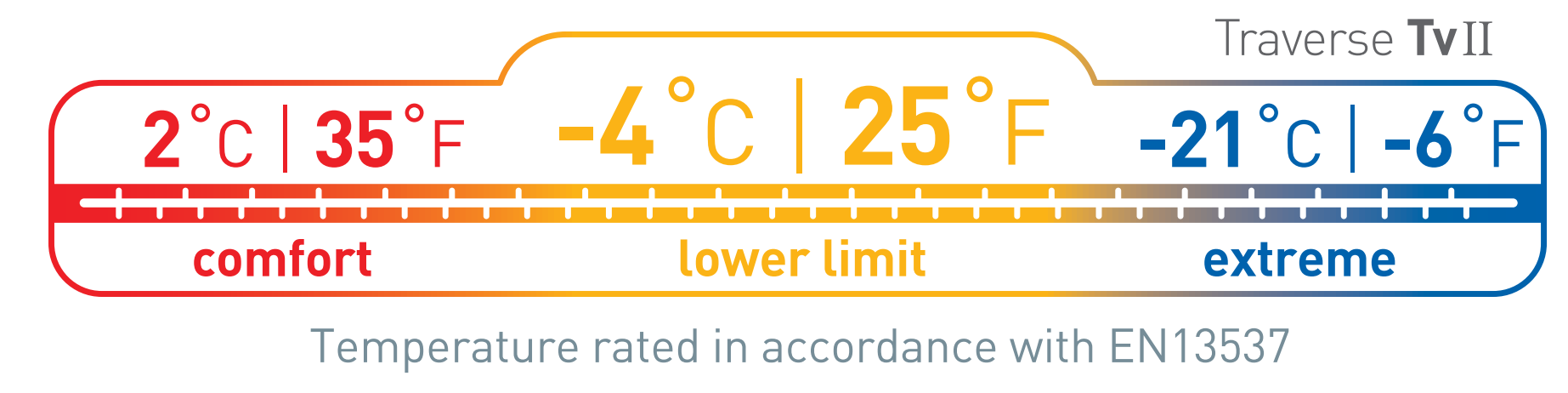

PRODUCT NAME	CODE	SIZE	MAX USER HEIGHT	WEIGHT	COMPRESSED SIZE	STORAGE	BAFFLE CONSTRUCTION	RRP
Traverse TvII	ATV1-R	Regular	< 183 cm 6'	1130g 39.9 oz	ø18.5 x 27cm 7.3L	S / 10L		
	ATV1-L	Long	< 198 cm 6' 6"	1270g 44.8 oz	ø21 x 23cm 8.1L	M / 14L	WaveLoft construction	
Traverse TvIII	ATV2-R	Regular	< 183 cm 6'	1440g 50.8 oz	ø21 x 28cm 9.8L			
	ATV2-L	Long	< 198 cm 6' 6"	1670g 58.9 oz	ø24 x 27cm 12.1L	L / 20L		

DESIGNED FOR Unisex design

ZIPS Full length YKK #5 side zip, two sliders. 1/2 length YKK #5 Free-flow zip. YKK #5 foot opening zip.

PAIRING This bag IS designed to pair with another

SHAPE Tapered rectangle

NECK DRAFT TUBE TvII: TvIII:

SECURITY POCKET



Venture Vt

Regular

148cm | 58"
148cm | 58"
118cm | 46"
<183cm | 6'

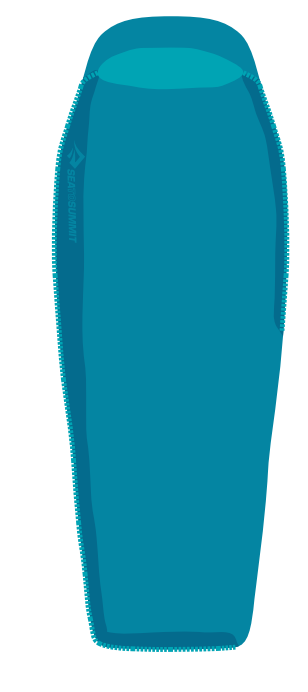

MAX USER HEIGHT

Long

152cm | 60"
152cm | 60"
122cm | 48"
<198cm | 6'6"

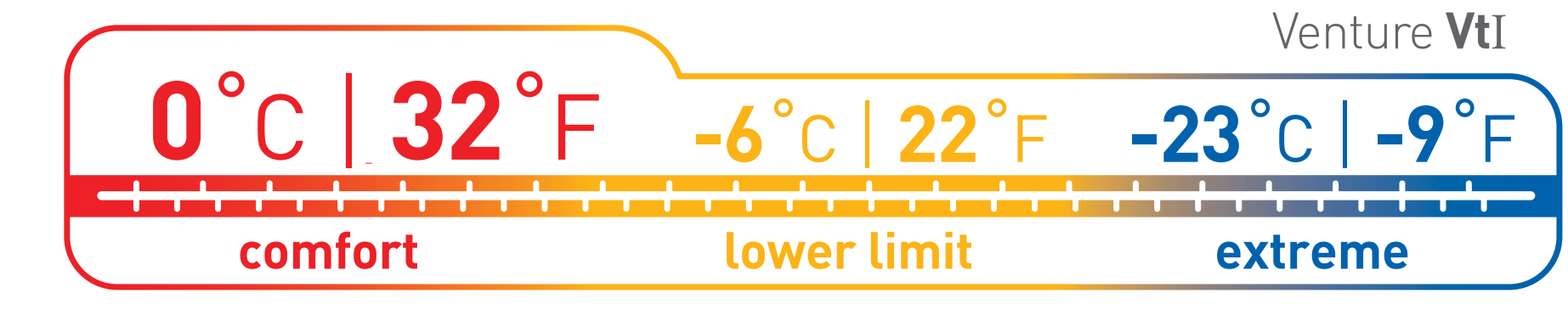

Temperature rated in accordance with EN13537

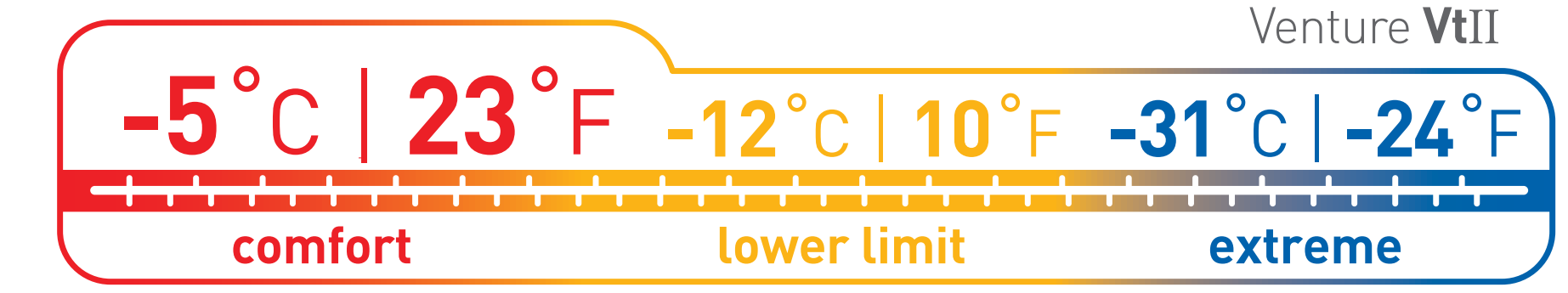

Temperature rated in accordance with EN13537



PRODUCT NAME	CODE	SIZE	MAX USER HEIGHT	WEIGHT	COMPRESSED SIZE	STORAGE	BAFFLE CONSTRUCTION	RRP
Venture VtI	AVT1-WR	Regular	< 170 cm 5' 7"	1090g 38.4 oz	ø18.5 x 25cm 6.6L	S / 10L		
	AVT1-WL	Long	< 183cm 6'	1240g 43.7 oz	ø21 x 22cm 7.6L		M / 14L	
Venture VtII	AVT2-WR	Regular	< 170 cm 5' 7"	1380g 48.7 oz	ø21 x 26cm 8.9L		WaveLoft construction	
	AVT2-WL	Long	< 183cm 6'	1550g 54.7 oz	ø24 x 25cm 11.5L	L / 20L		

- DESIGNED FOR** Women's specific design
- FEATURES** Thicker footbox insulation for increased warmth
- ZIPS** Full length YKK #5 side zip, two sliders. 1/2 length YKK #5 Free-flow zip. YKK #5 foot opening zip.
- PAIRING** This bag IS designed to pair with another
- SHAPE** Tapered rectangular
- NECK DRAFT TUBE**
- SECURITY POCKET**



Trailhead Th



A refined take on the classic synthetic trail bag, our Trailhead is packed full of technical features in a no fuss, uncomplicated design.

The perfect feature-packed, value oriented synthetic bag for weekend warriors and new campers.



Quest Qu



Engineered for women to provide extra warmth where needed, our Quest is packed full of technical features in a no fuss, uncomplicated design.

The perfect feature-packed, value oriented synthetic bag for weekend warriors and new campers.



ENGINEERED FOR WOMEN





Trailhead Th

Regular	Reg Wide		Long
148cm 58"	172cm 68"		152cm 60"
148cm 58"	161cm 63"		152cm 60"
118cm 46"	122cm 48"		122cm 48"
<183cm 6'	<183cm 6'		<198cm 6'6"

MAX USER HEIGHT

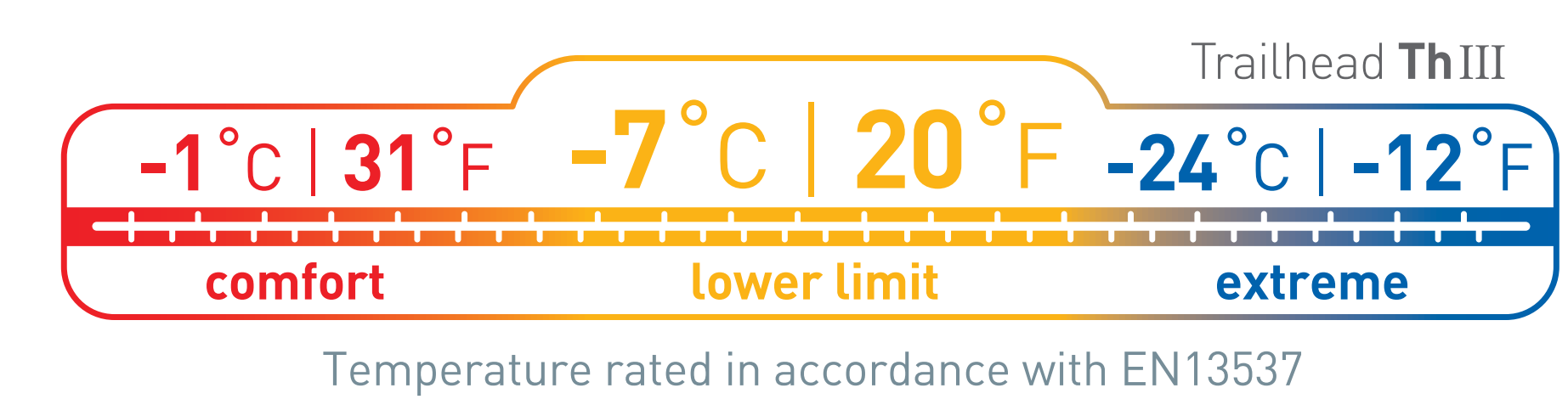
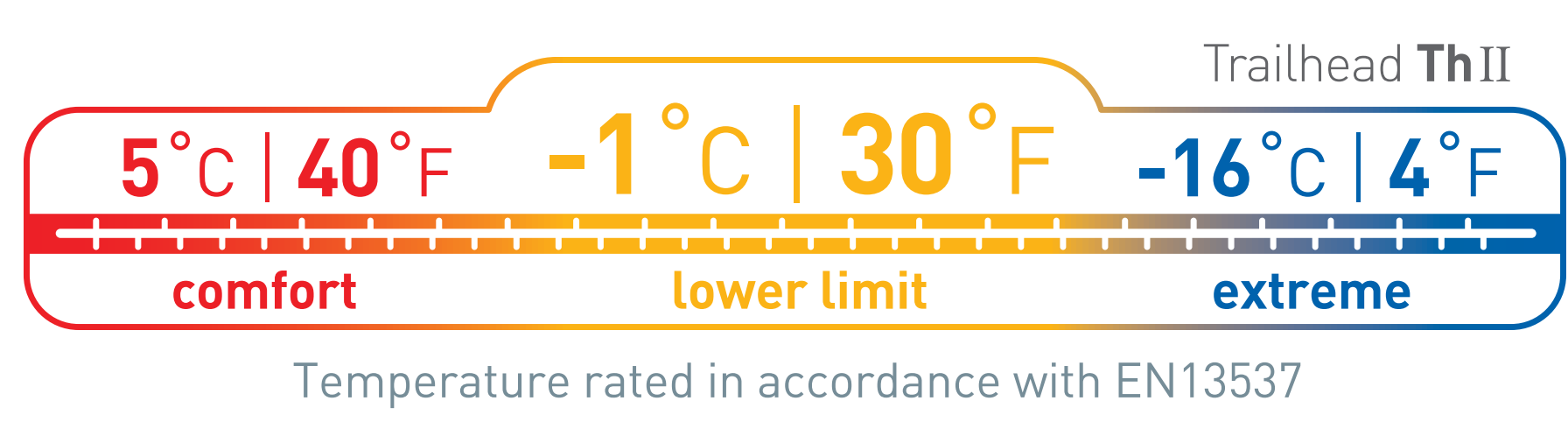

PRODUCT NAME	CODE	SIZE	MAX USER HEIGHT	WEIGHT	COMPRESSED SIZE	STORAGE	BAFFLE CONSTRUCTION	RRP
Trailhead ThII	ATH2-R	Regular	< 183 cm 6'	1040g 36.7 oz	ø18.5 x 26cm 7.1L	S / 10L	WaveLoft construction	
	ATH2-RW	Regular Wide		1220g 0 oz	ø21 x 23cm 8.0L			
	ATH2-L	Long	< 198 cm 6' 6"	1200g 42.3 oz	ø21 x 27cm 9.3L	M / 14L		
Trailhead ThIII	ATH3-R	Regular	< 183 cm 6'	1370g 48.3 oz	ø21 x 29cm 10.2L			
	ATH3-RW	Regular Wide		1550g 0 oz	ø24 x 24cm 10.9L	L / 20L		
	ATH3-L	Long	< 198 cm 6' 6"	1530g 54 oz	ø24 x 27cm 12.1L			

- DESIGNED FOR: Unisex design
- ZIPS: YKK #5 full length side and foot zip, two sliders.
- ZIPS: Full length zipper allows bag to be used as a quilt
- PAIRING: This bag is NOT designed to pair with another
- SHAPE: Tapered rectangular
- NECK DRAFT TUBE:
- SECURITY POCKET:



Quest Qu

Regular	Long
148cm 58"	152cm 60"
148cm 58"	152cm 60"
118cm 46"	122cm 48"
<183cm 6'	<198cm 6'6"

MAX USER HEIGHT

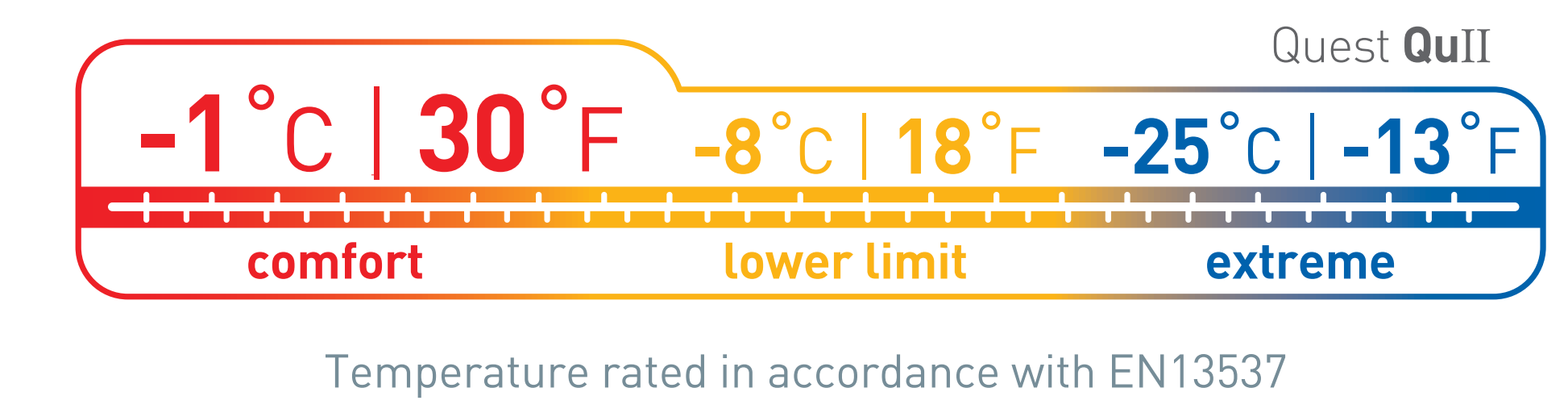
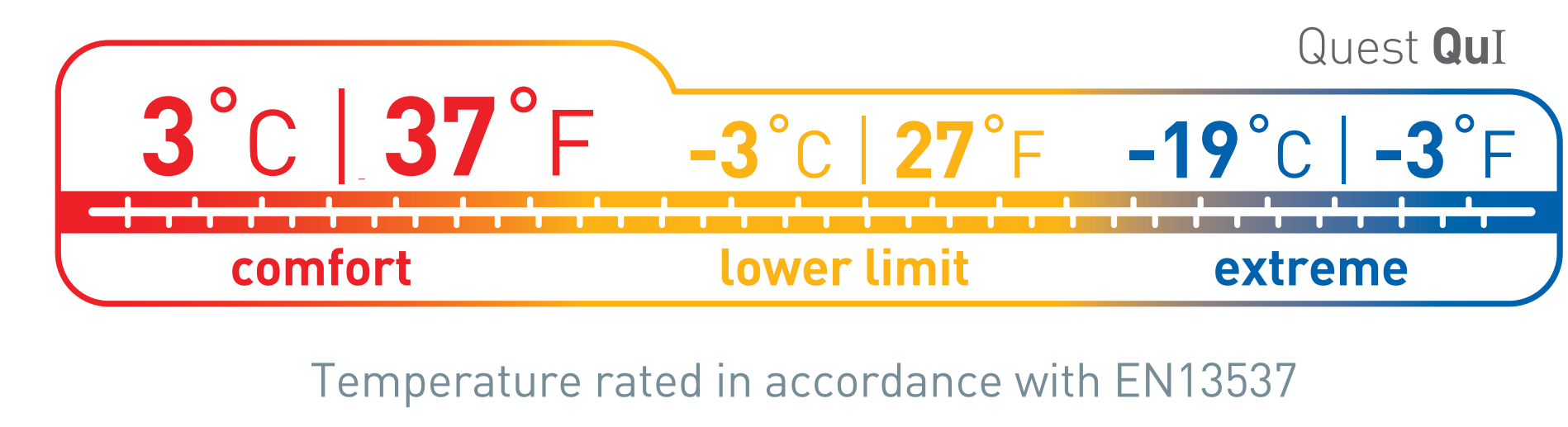
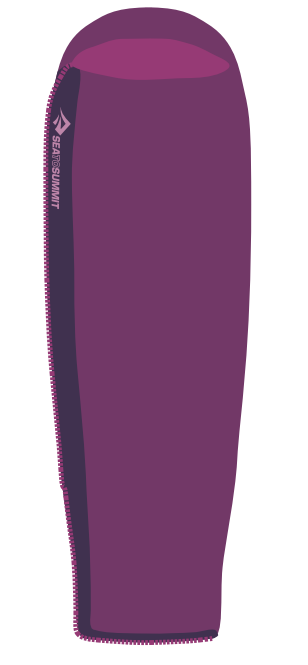

PRODUCT NAME	CODE	SIZE	MAX USER HEIGHT	WEIGHT	COMPRESSED SIZE	STORAGE	BAFFLE CONSTRUCTION	RRP
Quest QuI	AQU1-WR	Regular	< 170 cm 5' 7"	1030g 36.3 oz	ø18.5 x 26cm 6.9L	S / 10L		
	AQU1-WL	Long	< 183cm 6'	1160g 40.9 oz	ø21 x 24cm 8.3L			
Quest QuII	AQU2-WR	Regular	< 170 cm 5' 7"	1340g 47.3 oz	ø21 x 28cm 9.8L	M / 14L	WaveLoft construction	
	AQU2-WL	Long	< 183cm 6'	1490g 52.6 oz	ø24 x 25cm 11.2L	L / 20L		

- DESIGNED FOR** Women's specific design
- FEATURES** Thicker footbox insulation for warmer feet
- ZIPS** YKK #5 full length side and foot zip, two sliders.
- PAIRING** This bag is NOT designed to pair with another
- FEATURES** Full length zipper allows bag to be used as a quilt
- SHAPE** Tapered rectangular
- NECK DRAFT TUBE**
- SECURITY POCKET**



QUILTS + COMFORTERS

Ditch the zipper, free the arms and embrace the versatility of a technical quilt.

Sea to Summit has a broad range of technical quilts with an option for whether you are minimalist couch-surfing, all the way through to sleeping comfortably in a van or roof top tent.

But a camp quilt from Sea to Summit is also more than just a puffy blanket to keep your legs warm on a cool night. Our Quilt Lock integration system also means that you can extend your sleeping bag to create a Sleep System that will easily cover an extra season of warmth.

For 2022 we have introduced both rectangular quilts, a technical double and warmer versions of some of our existing best-sellers.



Tanami TmI 10c | 50F

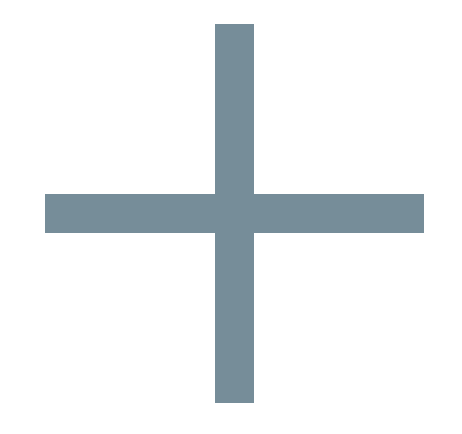

OUR QUILTS AND COMFORTERS INCLUDE:



CO DWR

PFC-Free Fabrics with CO treatment provide environmentally friendly resistance to condensation or other moisture.



NO WASTED WARMTH

A top drawcord helps pull your quilt in tight and press studs along the top edge allow it to be secured around your neck to help trap warmth.



QUILT LOCK SYSTEM

Every Sleeping Bag can combine with a quilt to increase warmth.

OPTIONAL FOOTBOX

A drawcord on the base of the quilt pulls tight to create a footbox, perfect for securing your mat and keeping your feet toasty warm.

HAND POCKETS

Small pockets on the top corner of the quilt helps draw it closer around you, even when sleeping in a natural, side position.



SECURE ATTACHMENT

Press Stud and Adjustable Strap System allows the quilt to be secured under your mat to retain maximum warmth.



EXPLORE THE RANGE – QUILTS + COMFORTERS

DOWN COMFORTERS

DOWN QUILTS

SYNTHETIC QUILTS

Tanami **Tm**



Ember **Eb**



Cinder **Cd**



Glow **GW**



Tanami **TmI**
10c | 50F

Tanami **TmII**
2c | 35F

Ember **EbI**
10c | 50F

Ember **EbII**
2c | 35F

Ember **EbIII**
-4c | 25F

Cinder **CdI**
10c | 50F

Cinder **CdII**
2c | 35F

Glow **GwI**
10c | 50F

Glow **GwII**
2c | 35F



NEW

Tanami Tm



A summer camping two-person 750+ high-loft down comforter that's made for life on the road.

The queen-sized Tanami Tm down comforter brings all the comfort of home to four-wheeled summer camping adventures. Featuring high-loft 750+ ULTRA-DRY Down, an oversized rectangular shape with sewn-through quilted baffles and soft, durable fabrics, it provides lightweight warmth and packability for its size.



ULTRA-DRY Down™
750+ Loft





Tanami Tm

Queen

210cm | 83"
210cm | 83"
210cm | 83"
<183cm | 6'



MAX USER HEIGHT

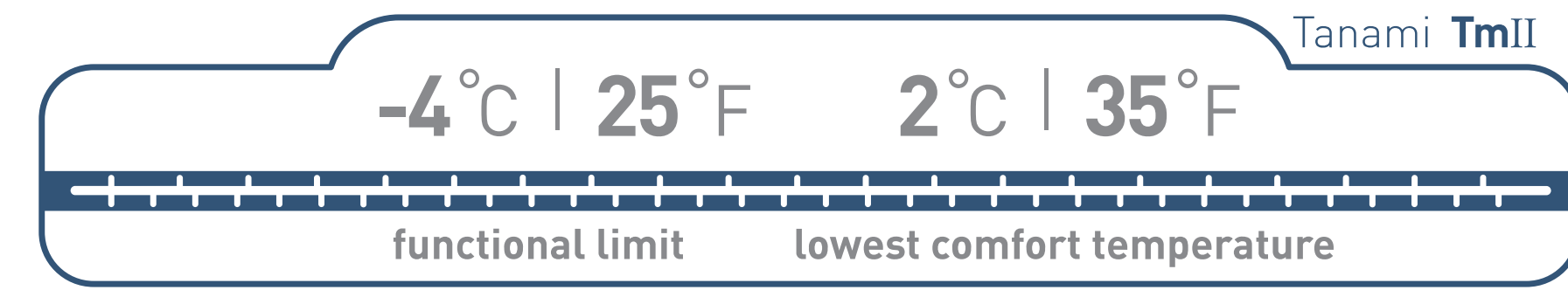
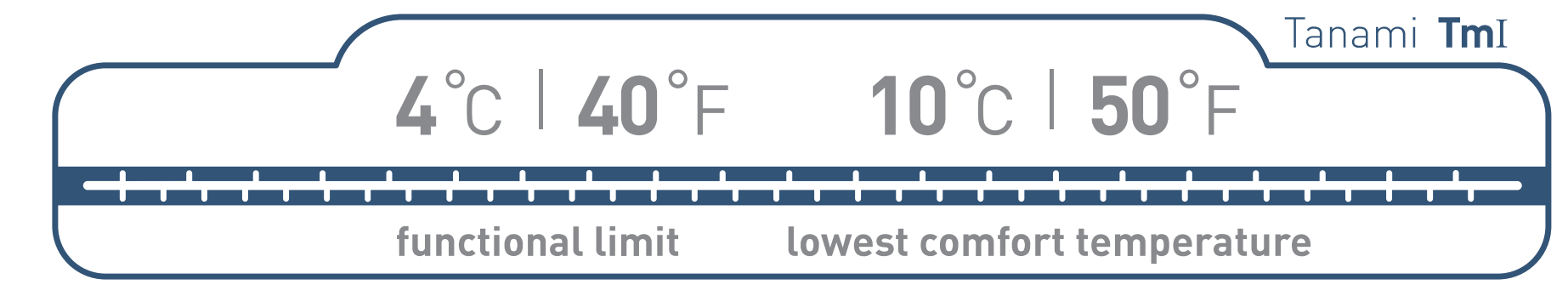

PRODUCT NAME	CODE	SIZE	MAX USER HEIGHT	WEIGHT	FILL WEIGHT	STORAGE CELL DIMENSIONS	BAFFLE CONSTRUCTION	RRP
Tanami TmI	ATM1-Q	Queen	< 183cm 6'	815g 28.7oz	350g 12.3oz	38 x 22 x 16cm	Box quilted sewn through baffles	
Tanami TmII	ATM2-Q	Queen	< 183cm 6'	1200g 42.3oz	700g 24.7oz	48 x 33 x 20cm	Narrow horizontal box wall baffles	

- DESIGNED FOR** Unisex design
- PAIRING** This quilt is NOT designed to pair with another
- SHAPE** Open rectangular quilt/comforter

NECK DRAFT TUBE

SECURITY POCKET



Ember



The same fastidious attention to design detail that has made our Spark and Flame bags so successful has also created a range of ultra-light quilts.

Our Ember Quilts are loved by through-hikers, cycle tourers and anyone looking for unconventional warmth in a tiny compressed size.





Ember Eb

EbI

Regular	DRAWCORD FOOTBOX	Long	DRAWCORD FOOTBOX	Double
120cm 47"		140cm 55"		190 cm 75 in
150cm 59"		170cm 67"		210 cm 83 in
87cm 34"		97cm 38"		155 cm 61 in
<183cm 6'	MAX USER HEIGHT	<198cm 6'6"	MAX USER HEIGHT	<183cm 6'

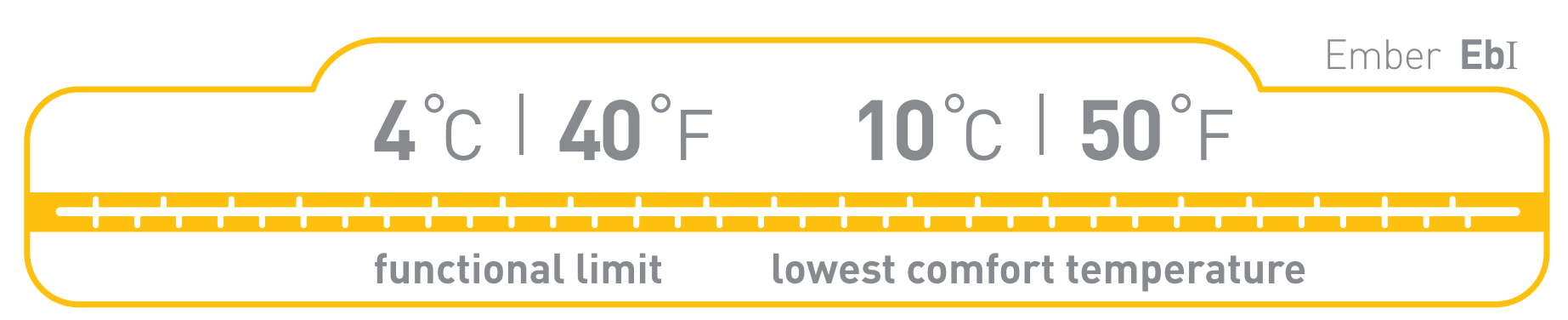

EbII

Regular	DRAWCORD FOOTBOX	Long
120cm 47"		140cm 55"
150cm 59"		170cm 67"
87cm 34"		97cm 38"
<183cm 6'	MAX USER HEIGHT	<198cm 6'6"

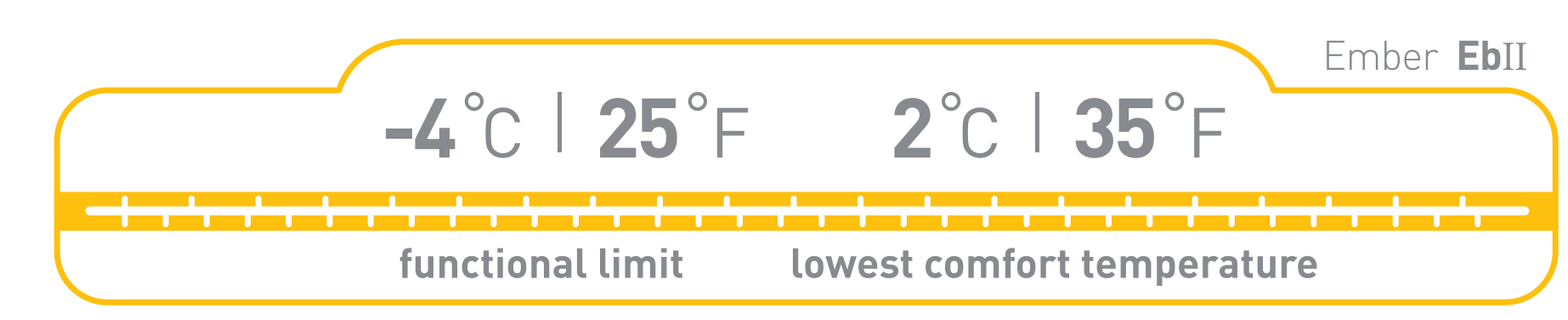

EbIII

Regular	3D FOOTBOX	Long
120cm 47"		140cm 55"
150cm 59"		170cm 67"
100cm 39"		110cm 43"
<183cm 6'	MAX USER HEIGHT	<198cm 6'6"

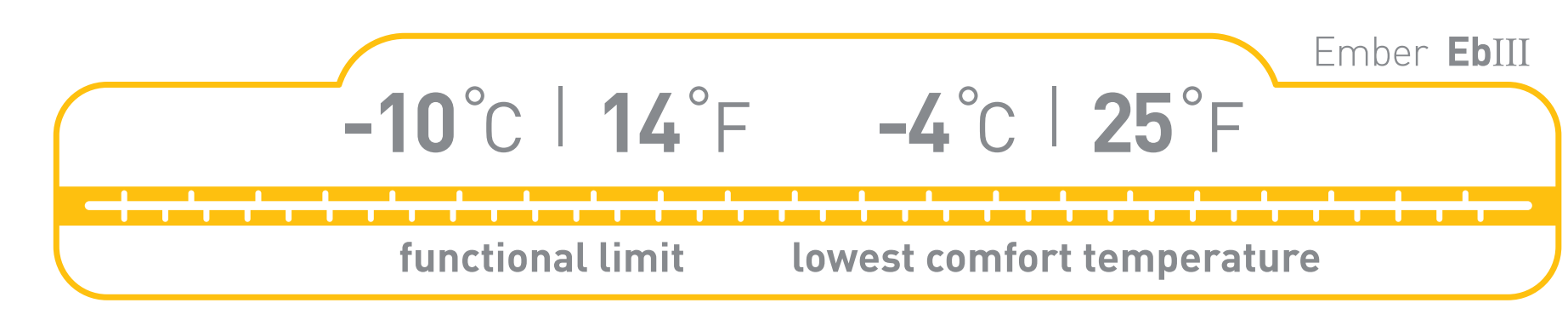

PRODUCT NAME	CODE	SIZE	MAX USER HEIGHT	WEIGHT	FILL WEIGHT	COMPRESSED SIZE	STORAGE	BAFFLE CONSTRUCTION	RRP
Ember EbI	AEB1-R	Regular	< 183 cm 6'	420g 14.8 oz	200g 7.1 oz	ø13 x 14cm 1.8L	2XS / 3.3L	Box quilted sewn through baffles	
	AEB1-L	Long	< 198 cm 6' 6"	480g 17 oz	230g 8.1 oz	ø13 x 20cm 2.7L			
	NEW AEB1-D	Double	< 183 cm 6'	650g 22.9oz	350g 12.3oz	ø18.5 x 18cm 4.7L	S / 10L		
Ember EbII	AEB2-R	Regular	< 183 cm 6'	600g 23 oz	350g 12.3 oz	ø15.5 x 20cm 3.7L	XS / 6L	Vertical chest baffles, horizontal baffles lower half, box wall baffle construction throughout	
	AEB2-L	Long	< 198 cm 6' 6"	680g 24 oz	400g 14.1 oz	ø15.5 x 26cm 4.9L			
Ember EbIII	AEB3-R	Regular	< 183 cm 6'	725g 26 oz	500g 17.6 oz	ø18.5 x 20cm 5.4L	S / 10L	Vertical chest baffles, horizontal baffles lower half, box wall baffle construction throughout, sewn in footbox	
	AEB3-L	Long	< 198 cm 6' 6"	830g 29 oz	575g 20.3 oz	ø18.5 x 25cm 6.8L			

- DESIGNED FOR: Unisex design
- CLOSURE: Press stud closure
- PAIRING: This quilt IS designed to pair with another
- SHAPE: EbI-II: Open tapered quilt/mummy bag; EbIII: Box foot tapered quilt/mummy bag
- NECK DRAFT TUBE: EbI: ; EbII-III:
- SECURITY POCKET:
- EXTRAS SUPPLIED: Removable straps to secure quilt to mattress with low profile quick release adjustable buckle



Cinder Cd



Think outside the bag
—a lightweight summer
down quilt or extra warmth
on top of your bag—your
adventure, your choice.



Glow GW



Light, packable standalone
synthetic summer quilt or
pair it with a sleeping bag to
boost performance.



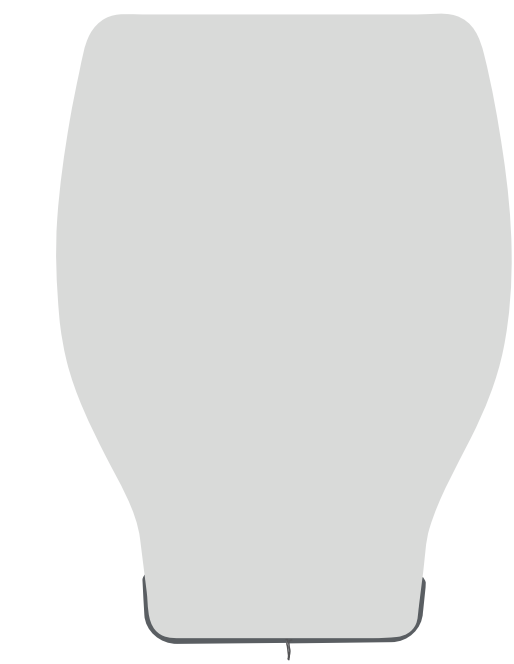

Cinder Cd

Regular	DRAWCORD FOOTBOX	Long
120cm 47"		140cm 55"
150cm 59"		170cm 67"
87cm 34"		97cm 38"
<183cm 6'	MAX USER HEIGHT	<198cm 6'6"

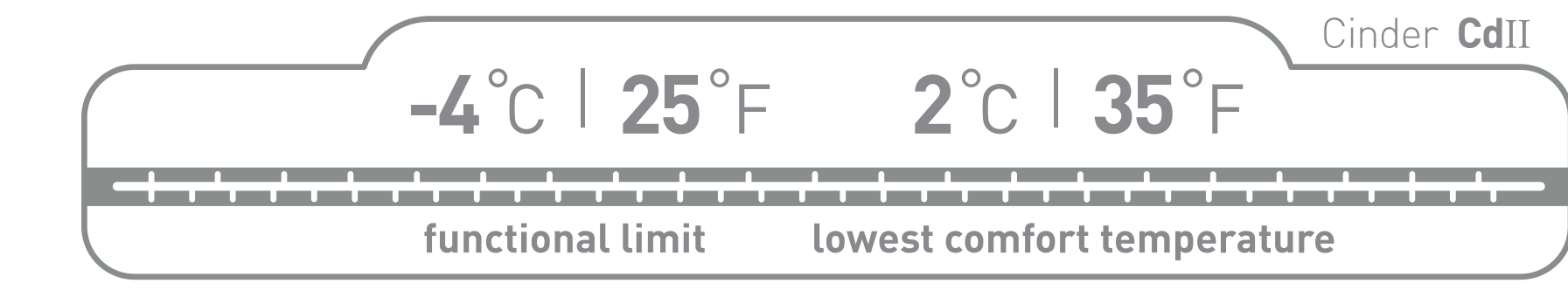
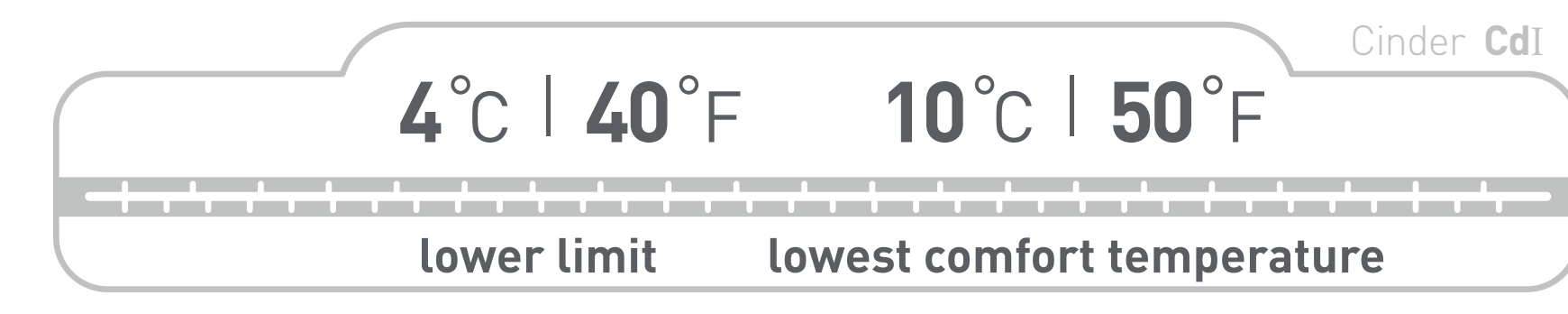

PRODUCT NAME	CODE	SIZE	MAX USER HEIGHT	WEIGHT	FILL WEIGHT	COMPRESSED SIZE	STORAGE	BAFFLE CONSTRUCTION	RRP
Cinder CdI	ACD1-R	Regular	< 183cm 6'	480g 16.9 oz	240g 8.5 oz	ø15.5 x 12cm 2.3L	XS / 6L	Box quilted sewn through baffles	
	ACD1-L	Large	< 170 cm 5' 7"	620g 21.9 oz	300g 10.6 oz	ø18.5 x 13cm 3.5L	S / 10L		
Cinder CdII	NEW ACD2-R	Regular	< 183cm 6'	660g 23.3oz	420g 14.8oz	ø18.5 x 17cm 4.6L	S / 10L	Vertical chest baffles, horizontal baffles lower half, box wall baffle construction throughout	
	NEW ACD2-L	Large	< 170 cm 5' 7"	790g 1lbs 11.9oz	500g 17.6oz	ø21 x 17cm 5.7L	M / 14L		

- DESIGNED FOR** Unisex design
- CLOSURE** Press stud closure
- PAIRING** This quilt IS designed to pair with another
- SHAPE** Open tapered quilt/mummy bag
- NECK DRAFT TUBE** CdI: CdII:
- SECURITY POCKET**
- EXTRAS SUPPLIED** Removable straps to secure quilt to mattress with low profile quick release adjustable buckle



Glow Gw

Regular **DRAWCORD FOOTBOX** Long

120cm 47"		140cm 55"
150cm 59"		170cm 67"
87cm 34"		97cm 38"
<183cm 6'		<198cm 6'6"

MAX USER HEIGHT

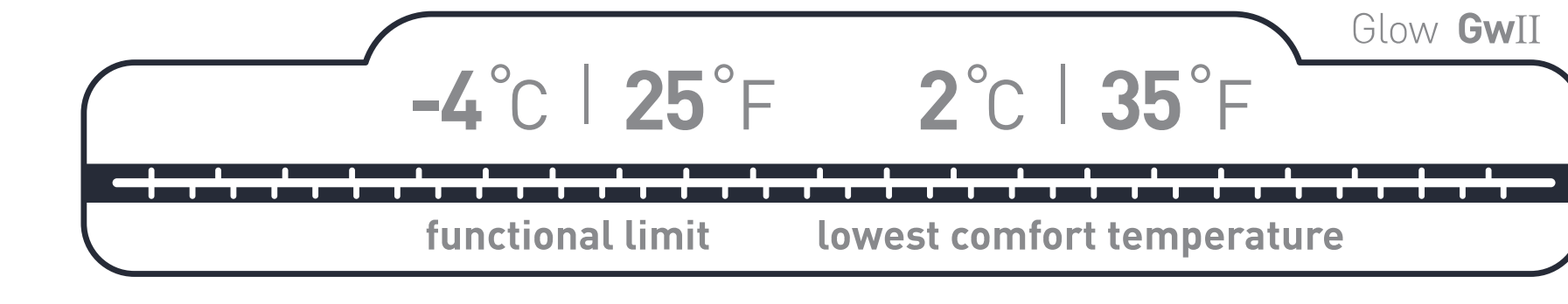
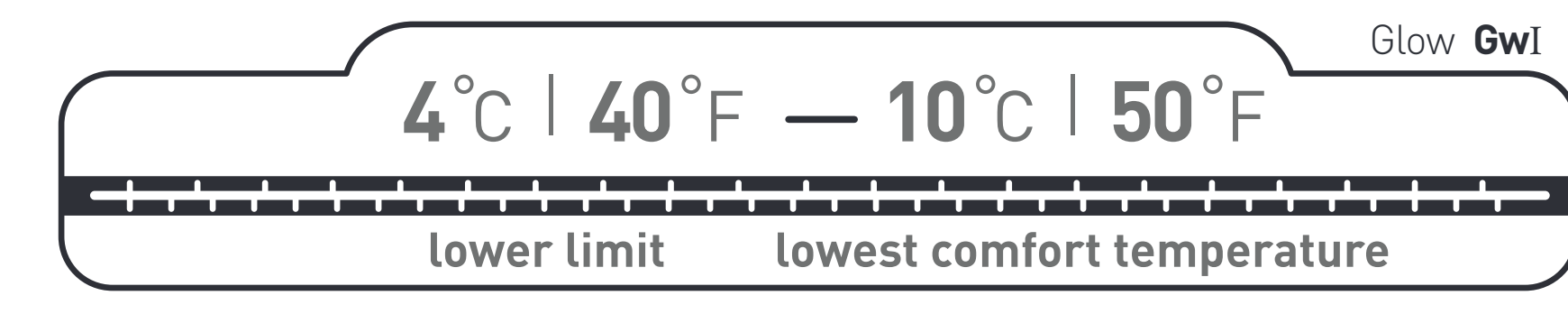

PRODUCT NAME	CODE	SIZE	MAX USER HEIGHT	WEIGHT	COMPRESSED SIZE	STORAGE	RRP
Glow GwI	AGW1-R	Regular	< 183cm 6'	650g 22.9 oz	ø15.5 x 18cm 3.4L	XS / 6L	
	AGW1-L	Long	< 170 cm 5' 7"	820g 28.9 oz	ø18.5 x 17cm 4.6L	S / 10L	
Glow GwII	NEW AGW2-R	Regular	< 183cm 6'	900g 31.7oz	ø21 x 20cm 6.9L	M / 14L	
	NEW AGW2-L	Long	< 170 cm 5' 7"	1030g 2lbs 4.3oz	ø21 x 22cm 7.6L		

- DESIGNED FOR** Unisex design
- CLOSURE** Press stud closure
- PAIRING** This quilt IS designed to pair with another
- SHAPE** Open tapered quilt/mummy bag
- NECK DRAFT TUBE**
- SECURITY POCKET**
- EXTRAS SUPPLIED** Removable straps to secure quilt to mattress with low profile quick release adjustable buckle



LINERS

The humble Liner is really the unsung hero of your Sleep System. You might not appreciate it, but you will definitely miss it when it's not there!

Think of your liner in the same way as you think about the sheets on your bed at home. It's the first point of contact between you and the rest of the system.

We've been refining our liner product for over thirty years and now offer a range of models to suit any consumer.



SOFT + COMFORTABLE

All our liners have great hand feel, and are soft and comfortable next to skin. Some are stretchy and knitted for people who move around during sleep and don't want to feel constricted. Others are more static, so that they don't tangle.

CONVENIENT

Because they are acting as a 'sheet' between you and your sleeping bag, it means that you won't need to launder your bag as often (or at all), because all the grime, oil and sweat that you may exude during sleep is captured in your liner.

EASY CARE

In between uses, you'll appreciate the fact that they are easy care, and can all be washed in a regular top loading washing machine. And they all come in a stuff sack or zippered pouch to minimise space and keep them small and compact when packed away.



EXPLORE THE RANGE

PERFORMANCE LINERS



REACTOR



REACTOR PLUS



REACTOR EXTREME



REACTOR FLEECE

TRAVEL LINERS



SILK+COTTON



COTTON



EXPANDER



SILK



ADAPTOR



FLEECE

STANDARD

Rectangular

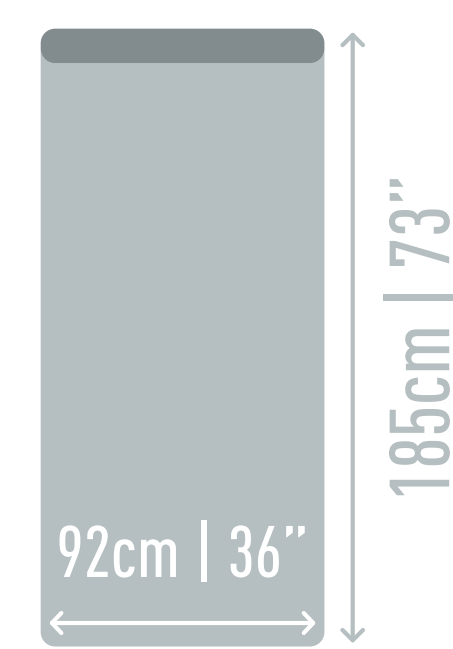

LONG

Rectangular



DOUBLE

Extra Wide

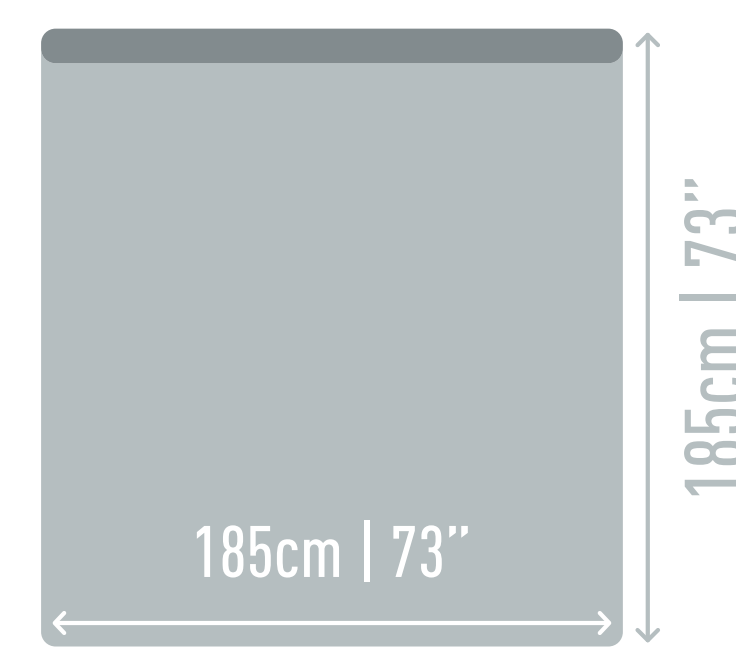

MUMMY

Tapered

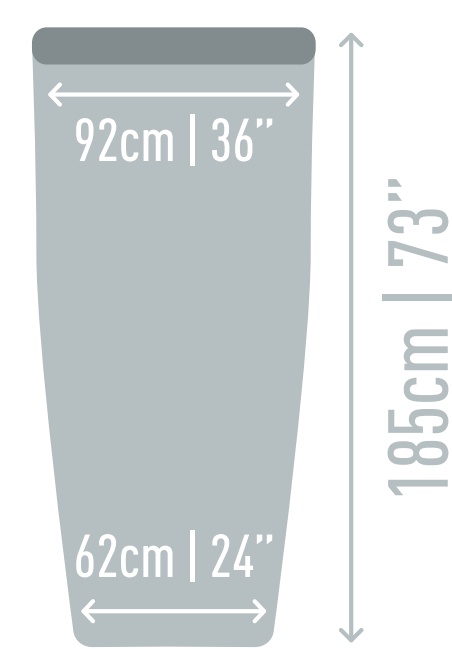

MUMMY

Hood



TRAVELLER

Pillow Insert



MUMMY

Box Foot

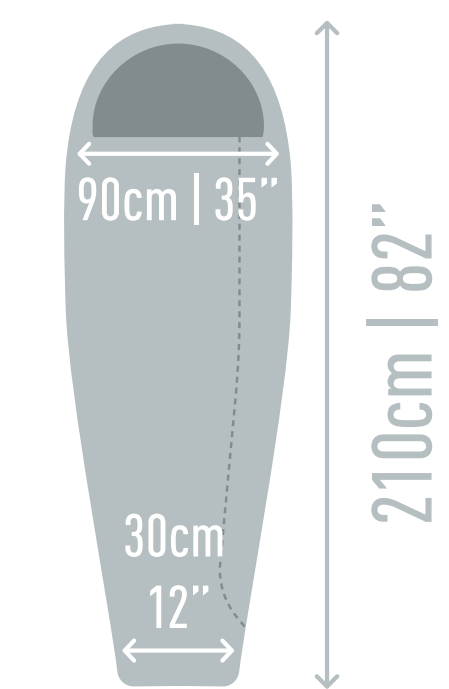



REACTOR SERIES LINERS

Our Reactor Series sleeping bag liners are your best choice for adding warmth to your bag.

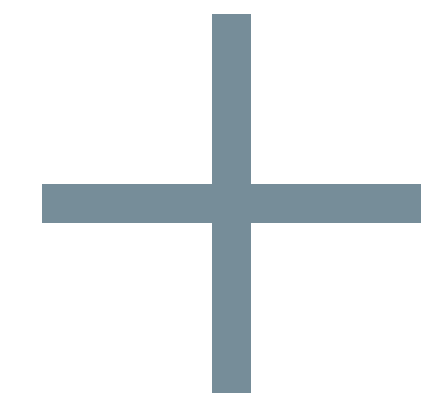

OUR REACTOR SERIES LINERS FEATURE:

EASE OF USE

Contrasting colour along the top edge makes it easier to find the opening.

COMFORT

A knitted fabric stretches and moves with you as you sleep.

WARMTH

THERMOLITE is a hollow core fibre with fantastic insulating properties, adding warmth and comfort to your bag.

VERSATILITY

Add warmth in cold conditions, or use a stand alone bag on balmy summer nights.

COMPACT + CONVENIENT

Packs into its own Ultra-Sil stuff sack.





REACTOR

REACTOR COMPACT PLUS+

REACTOR EXTREME

REACTOR FLEECELINER



THERMOLITE® REACTOR

Extend the comfort range of your sleeping bag with our most popular technical liner.

COLOUR



THERMOLITE® REACTOR COMPACT PLUS

Perfect for cold-sleeping gram counters under six feet tall.

FEATURES

- Compact, shorter design is ideal for women and cold-sleepers under six feet

COLOUR



THERMOLITE® REACTOR EXTREME

Ideal as part of a cold climate sleep system or standalone bag in warm weather.

SIZES Regular / Long

COLOUR



THERMOLITE® REACTOR FLEECE

It's so warm, you can use this fleece liner in your sleeping bag or on its own.

FEATURES

- Quarter zip makes it easy to get in and out

COLOUR





TRAVEL LINERS



SILK+COTTON TRAVEL LINER

A blend of soft cotton and luxurious silk creates an ideal travel liner.

FEATURES

- Feels similar to a high-thread count cotton sheet

COLOURS



VIDEO



PREMIUM COTTON TRAVEL LINER

High thread count 100% premium cotton liner for travel adventures.

FEATURES

- High thread count cotton for comfort and durability

COLOURS



VIDEO



PREMIUM STRETCH KNIT EXPANDER

This liner is lightweight, breathable, durable and ideal for use while camping or in hostels.

FEATURES

- Stretch knit fabric that moves with you as you sleep

COLOURS



VIDEO



PREMIUM SILK TRAVEL LINER with Stretch Panels

A touch of travelling luxury—premium silk liner with stretch panels for extra comfort.

FEATURES

- Unique Comfort Stretch Panels allow the liner to move with you when you sleep

COLOURS





TRAVEL LINERS



PREMIUM FLEECE LINER

A great value option for adding additional warmth to your sleep system. This toasty microfleece liner is soft and comfortable next-to-skin, and can be used on its own for warm weather hut trips and as a warmth-boosting liner for your sleeping bag. It has a contoured hood with elastic drawcord and a full-length, low profile side zipper for easy venting and easy access.

FEATURES

- Full-length side zip

COLOUR

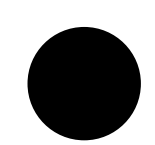

COOLMAX® ADAPTOR

When the temperature increases our Adaptor liner helps to wicks moisture away from your skin keeping you more comfortable as you sleep.

FEATURES

- Also works fantastically well as a regular sleeping bag liner in cooler conditions
- Contrasting colour along top edge makes it easier to find the opening

COLOUR





REACTOR LINERS

PRODUCT NAME	CODE	SIZE	ADDED WARMTH	DIMENSIONS	WEIGHT	MATERIALS	COLOUR	RRP
THERMOLITE® Reactor	AREACTOR	Mummy (box foot)	Up to 8°C 14°F	210 x 90cm 82.7 x 35.4 in	248g 9 oz	80g/m ² THERMOLITE®		
Reactor Compact Plus	AREACTPL	Mummy	Up to 11°C 20°F	210 x 90cm 82.7 x 35.4 in	263g 9.1 oz	80g/m ² THERMOLITE® 110g/m ² THERMOLITE® panels in core body and footbox		
Reactor Extreme	AREACTEX	Mummy (box foot)	Up to 15°C 25°F	210 x 90cm 82.7 x 35.4 in	399g 14.1 oz	110g/m ² THERMOLITE®		
Reactor Extreme Long	AREACTEXLONG			235 x 90cm 92.5 x 35.4 in	422g 14.9 oz			
Reactor Fleece	AREACTFLEECE	Mummy	Up to 18°C 32°F	200 x 70cm 78.7 x 27.6 in	380g 16 oz	THERMOLITE® fleece		

TRAVEL LINERS

PRODUCT NAME	CODE	SIZE	DIMENSIONS	WEIGHT	MATERIALS	COLOUR	RRP
Silk+Cotton Travel Liner	ASLKCTNDBL	Double	185 x 185cm 73 x 73 in	274g 9.7 oz	30% silk, 70% cotton		
	ASLKCTNHOOD	Mummy (Hood)	210 x 92cm 82.7 x 36.2 in	140g 4.9 oz			
	ASLKCTNLONG	Long		156g 5.5 oz			
	ASLKCTNMUMMY	Mummy (Tapered)	185 x 92cm 73 x 36.2 in	130g 4.6 oz			
	ASLKCTNSTD	Standard	185 x 92cm 72.8 x 34.7 in	142g 5 oz			
	ASLKCTNYHA	Traveller	225 x 92cm 88.6 x 36.2 in	168g 5.9 oz			
Premium Cotton Travel Liner	ADBLOS	Double	185 x 185cm 73 x 73 in	710g 17.6 oz	Cotton		
	ALONGOS	Long	210 x 92cm 82 x 36 in	395g 12.3 oz			
	AMUMMYOS	Mummy (Tapered)	185 x 92cm 73 x 36 in	325g 11.5 oz			
	ASTDOS	Standard		350g 8.7 oz			
	AYHAOS	Traveller	225 x 92cm 85 x 36 in	425g 13.4 oz			
	AYHOOD	Mummy (Hood)	210 x 92cm 82 x 36 in	370g 13.1 oz			



TRAVEL LINERS

PRODUCT NAME	CODE	SIZE	DIMENSIONS	WEIGHT	MATERIALS	COLOUR	RRP
Expander Liner	AEXPDBL	Double	185 x 185cm 73 x 73 in	500g 17.6 oz	Poly-cotton blend		
	AEXPHOOD	Mummy (Hood)	210 x 92cm 82 x 36 in	300g 10.6 oz			
	AEXPLONG	Long		350g 12.3 oz			
	AEXPSTD	Standard	185 x 92cm 73 x 36 in	248g 8.7 oz			
	AEXPYHA	Traveller	225 x 92cm 85 x 36 in	380g 13.4 oz			
Premium Silk Travel Liner	ASILKCSDB	Double	185 x 185cm 73 x 73 in	210g 7.4 oz	AA-Grade ripstop silk, polyester/Lycra panels		
	ASILKCSHOOD	Mummy (Hood)	210 x 92cm 82 x 36 in	132g 4.7 oz			
	ASILKCSLONG	Long		145g 5.1 oz			
	ASILKCSMUMMY	Mummy (Tapered)	185 x 92cm 73 x 36 in	125g 4.7 oz			
	ASILKCSSTD	Standard		130g 4.6 oz			
	ASILKCSYHA	Traveller	225 x 92cm 85 x 36 in	154g 5.4 oz			
Premium Fleece Liner	AFLEECE	Mummy (Box Foot)	195 x 90cm 76.8 x 33.5 in	580g 20.5 oz	Polyester		
COOLMAX® Adaptor	ACMAX	Mummy (Hood)	210 x 92cm 82 x 36 in	248g 8.7 oz	Polyester		
	ACMAXYHA	Traveller	225 x 92cm 88.6 x 36 in	328g 11.6 oz			



SLEEPING MATS

We don't believe the only reason to make a sleeping mat is to make it as light as possible—or pack down as small as possible. We know that it doesn't matter how small or light your sleeping mat packs if you can't get a decent nights' sleep.

Our overriding design objective is to create sleeping mats that are as light and packable as possible, without compromising on comfort.

Because a great sleep is the start to a good day.





AIR SPRUNG CELL MATS

Our award-winning Air Sprung Cell Sleeping Mats provide air cushioned comfort from the lumps and bumps beneath you.

COMFORTABLE



AIR SPRUNG CELLS

Stability = greater comfort. A pattern of dot-welds creates hundreds of interconnected chambers called Air Sprung Cells. Just like a pocket spring mattress, this matrix of cells provides unmatched support while conforming to the contours of the sleeper.



THERMOLITE® INSULATION

Designed for ultimate performance, THERMOLITE® is made from specially engineered fibres to achieve a high CLO value with low weight. The THERMOLITE® insulation lofts up inside the Air Sprung Cells to prevent convective heat loss from your warm body to the cold ground.



EXKIN PLATINUM®

A very lightweight, quiet, non-woven fabric that has a thin metalised layer applied to the surface which reflects radiant heat back to the user.

DURABLE



EXTRUSION TPU LAMINATION

Ultra-Fresh® anti-microbial treatment added to the TPU formula prevents internal mould growth.

DURABLE 30/40D NYLON FACE FABRIC

Lightweight, quiet and grippy 30/40D Nylon face fabric.

EASY TO USE



PILLOWLOCK SYSTEM

Pillow Lock attaches an Aeros pillow to mat.

REPAIR KITS

All ASC Mats ship with a set of peel and stick repair patches that provide quick and permanent solutions to any unfortunate punctures.



AIRSTREAM PUMPSACK

Includes an Airstream Pump that is integrated into the stuff sack for quick and easy inflation.

MULTI-FUNCTION VALVE

Multi-function valve provides fast inflate, deflate and easy fine-tuning for personalised comfort.



EXPLORE THE RANGE

SINGLE LAYER DESIGN					HYBRID LAYER DESIGN			DUAL LAYER DESIGN	
---------------------	--	--	--	--	---------------------	--	--	-------------------	--

Etherlight™ XT

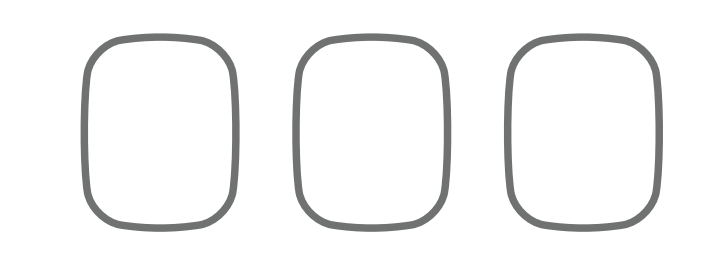

Ultra light™

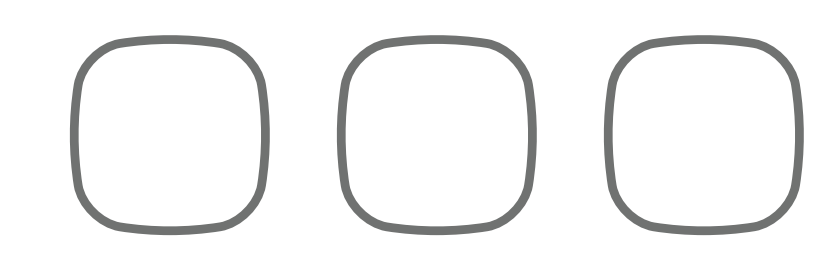

Comfort light™

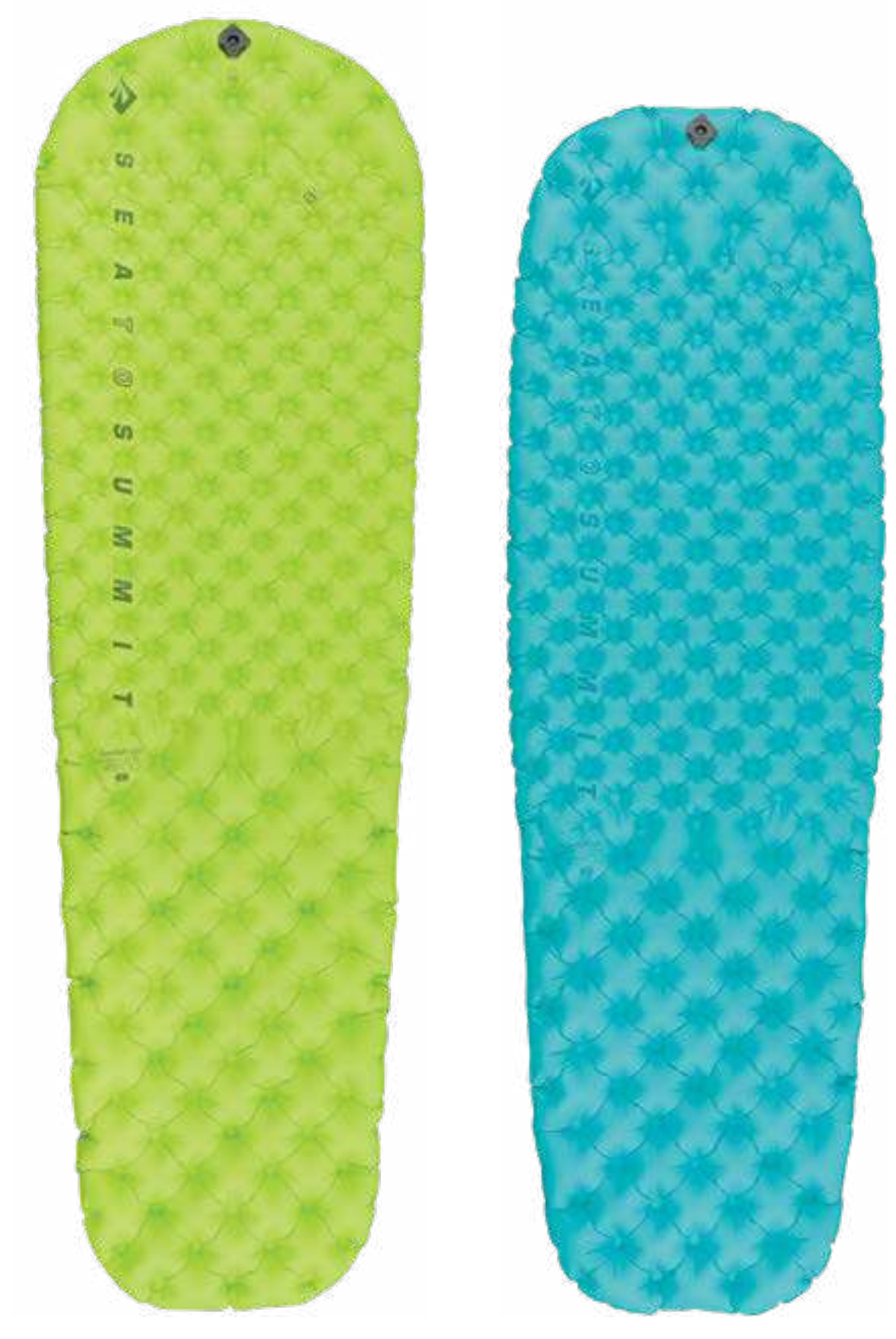
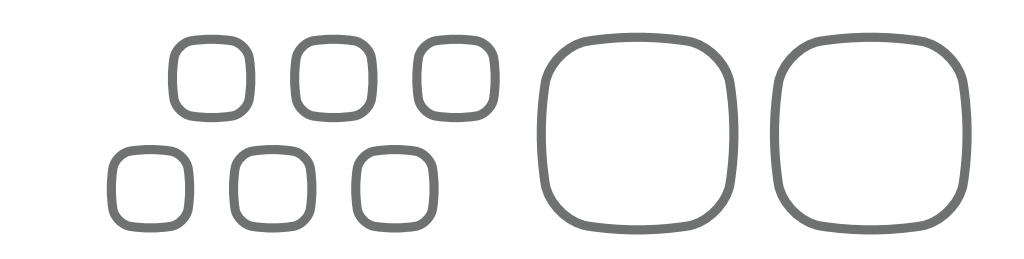

Comfort plus™

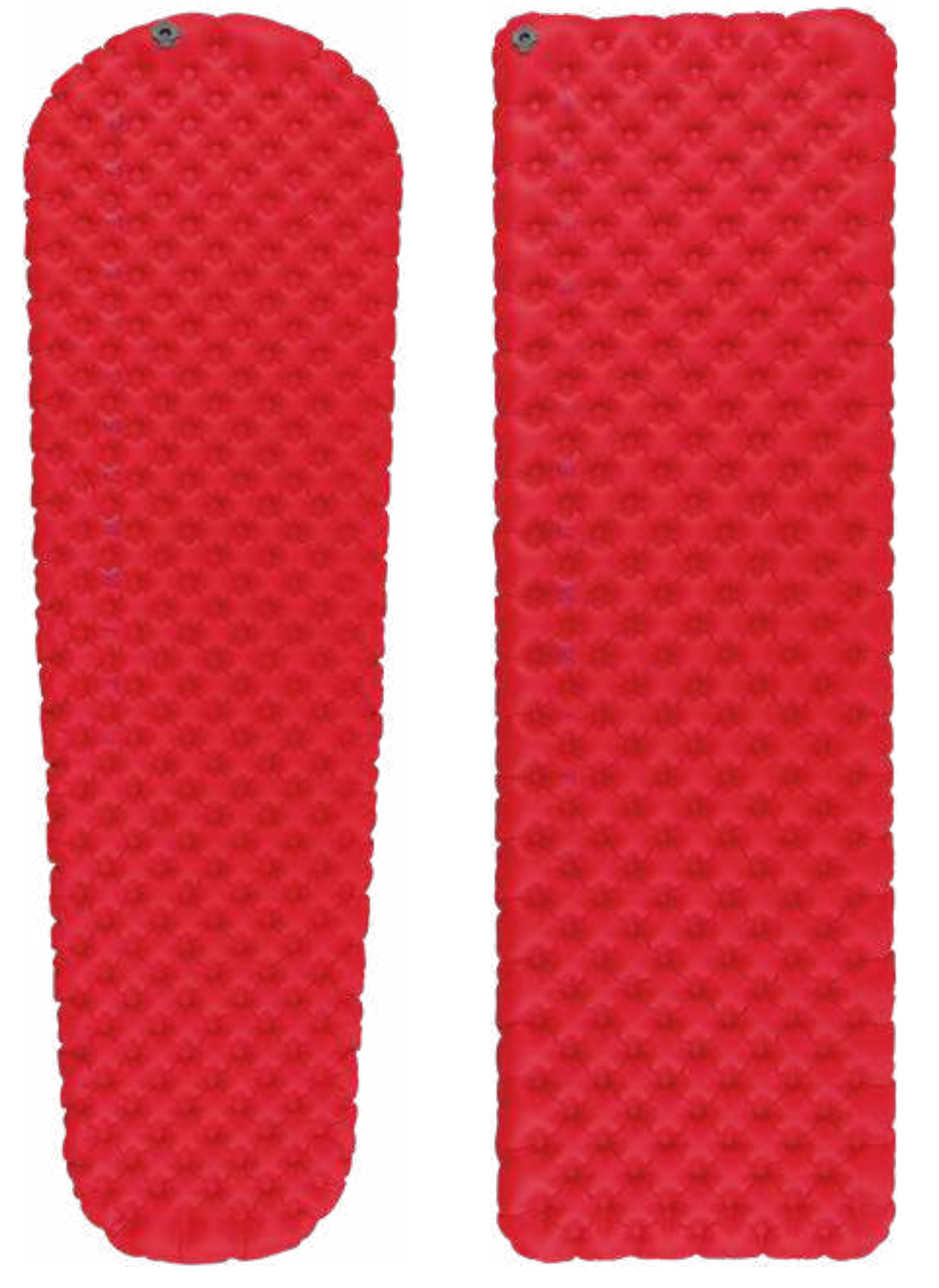
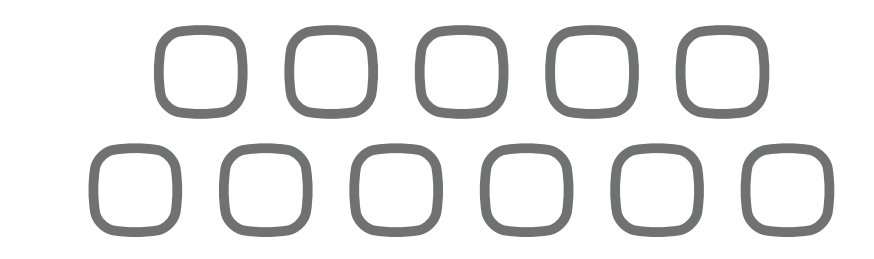

R-Value ASTM F3340-18												
--------------------------	--	--	--	--	--	--	--	--	--	--	--	--



Etherlight™ XT 000

SINGLE LAYER DESIGN

Ether light XT AIR

Ether light XT INSULATED

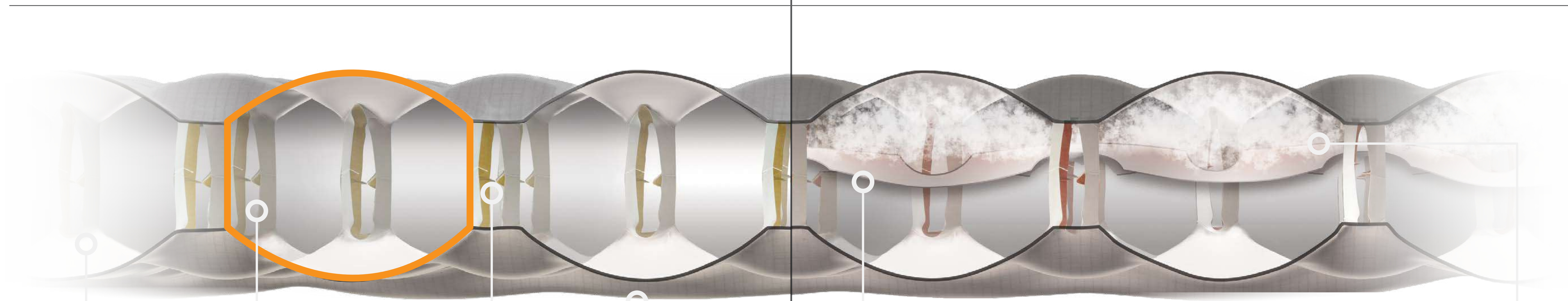

AIR SPRUNG CELL

TPU LOOPS

30/40D Nylon

Etherlite XT Insulated mats combine all the benefits of the Etherlite XT Air with the addition of:



REFLECTS RADIANT HEAT



PREVENTS CONVECTIVE HEAT TRANSFER

Our Etherlight Mat design creates a thicker mat, without increasing overall weight.



The innovative Ether-Light design created a thicker ASC mat with a lower overall weight. Accommodates any sleeping style, and with insulation ‘pinned’ to the top surface you’ll appreciate the balance between warmth and bulk.

Etherlight™XT
AIR



R-value
ASTM F3340-18
1.2

Thickness
10cm | 4in

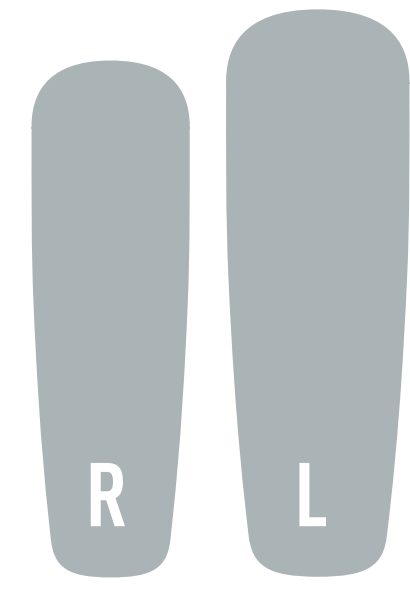

Etherlight™XT
INSULATED



R-value
ASTM F3340-18
3.2

Thickness
10cm | 4in

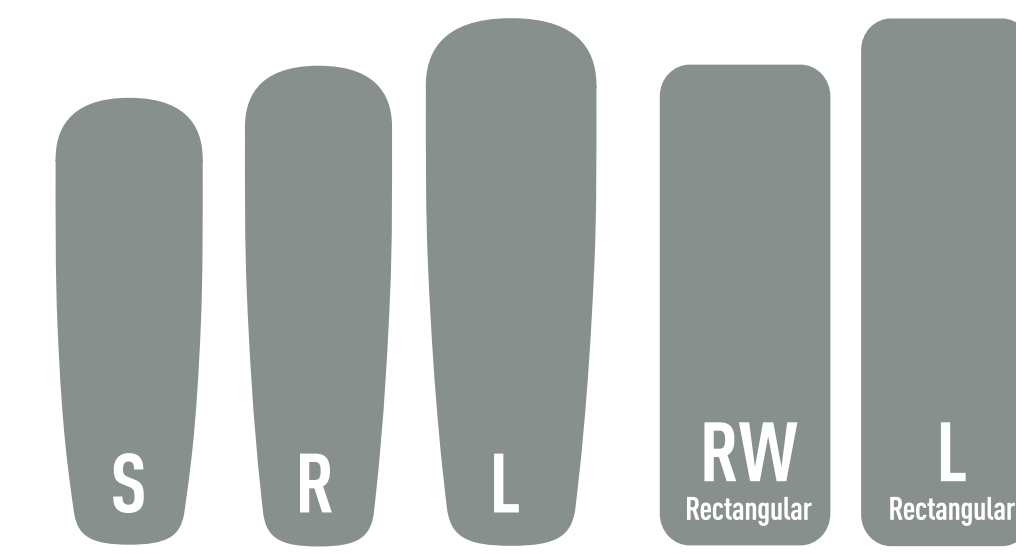

Exkin® PLATINUM

THERMOLITE®



Etherlight™XT
INSULATED



R-value
ASTM F3340-18
3.5

Thickness
10cm | 4in

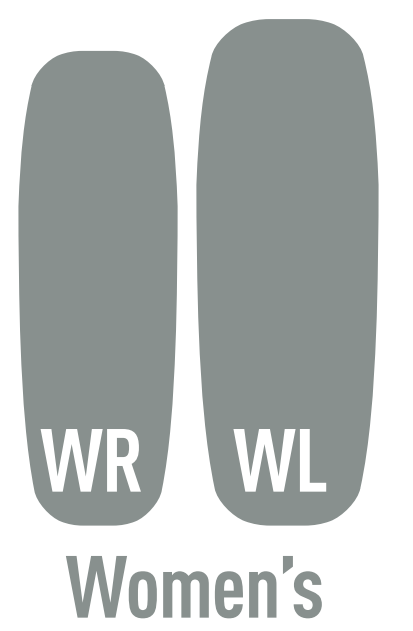

Exkin® PLATINUM

THERMOLITE®





Etherlight™ XT **000** EXTREME

SINGLE LAYER DESIGN

Ether Light XT **EXTREME**



Ether Light XT **EXTREME**

Extra Thick
and Extra Warm.

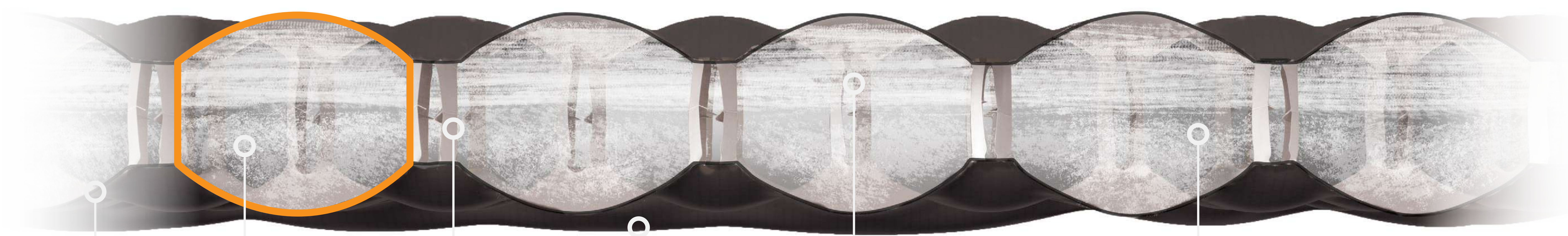

AIR SPRUNG CELL

TPU LOOPS

30/40D Nylon



PREVENTS CONVECTIVE HEAT TRANSFER



THERMOLITE HIGH LOFT BOTTOM LAYER



Designed with extreme conditions in mind, our unique 'dual-density' insulation will keep you comfortable by minimising convective airflow, no matter how cold the ground temperature might be.

Etherlight™XT
EXTREME



R-value **6.2**
ASTM F3340-18

Thickness
10cm | 4in

R L RW L
Rectangular Rectangular

THERMOLITE

+

Etherlight™XT
EXTREME



R-value **6.3**
ASTM F3340-18

Thickness
10cm | 4in

WR WL
Women's

THERMOLITE

+





Ultra light™ ○○○

SINGLE LAYER DESIGN

Ultra light AIR

Ultra light INSULATED



Ultra light Insulated mats combine all the benefits of the Ultra light with the addition of:

A single layer of medium resolution cells for minimal packed size and weight.



Our Ultra-Light Mats are our smallest and lightest models. They combine all the comfort and features of our Air Sprung Cell range with a nod to great value performance.



NATIONAL GEOGRAPHIC ADVENTURE

Ultralight



Ultralight Insulated

Ultra light AIR



R-value 1.1
ASTM F3340-18

Thickness 5cm | 2 in



Ultra light INSULATED



R-value 3.1
ASTM F3340-18

Thickness 5cm | 2 in



Exkin PLATINUM

THERMOLITE



Ultra light INSULATED



R-value 3.5
ASTM F3340-18

Thickness 5cm | 2 in

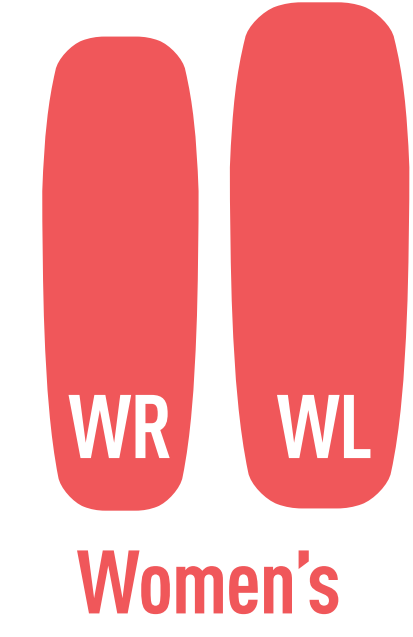

Exkin PLATINUM

THERMOLITE





Comfort light™

HYBRID LAYER DESIGN

Comfort light INSULATED

Comfort light INSULATED

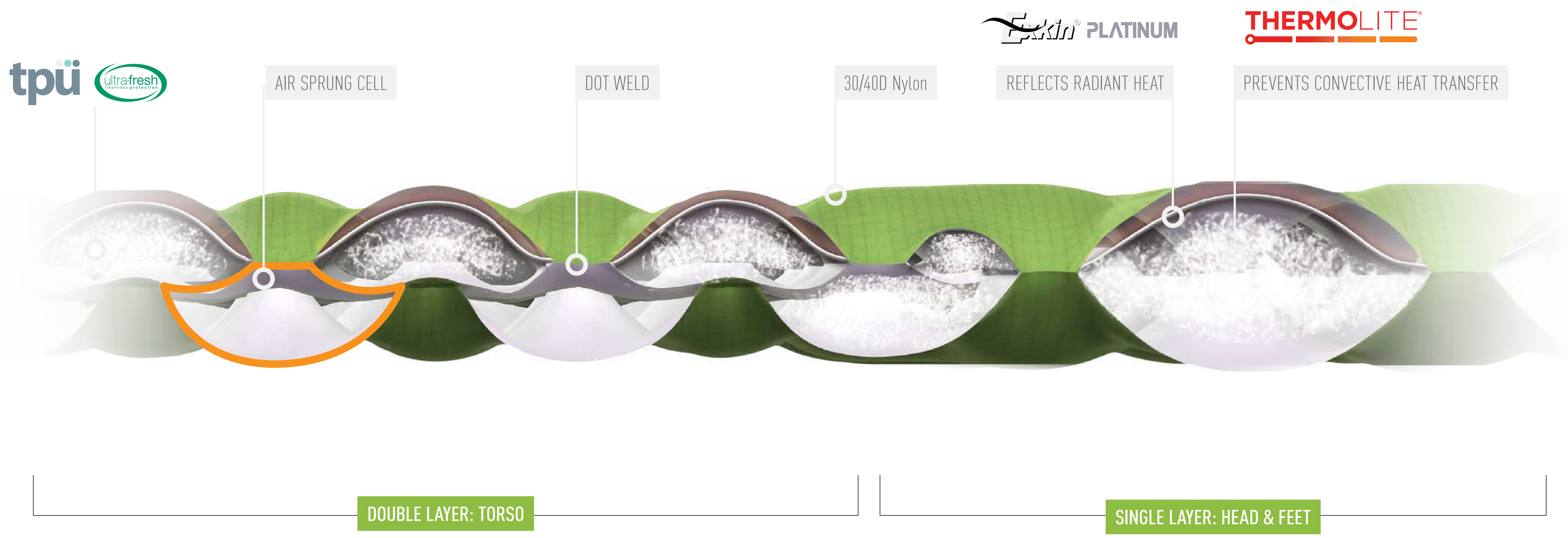

A double layer of high resolution cells in the torso for increased comfort, with a single layer of medium resolution cells in the head and legs for reduced weight.



The Comfort-Light mat uses a hybrid design that offers additional warmth and comfort, without a substantial increase in weight or bulk.

Comfort light
INSULATED



R-value
3.7
ASTM F3340-18
Torso double layer zone

Thickness
6.3cm | 2½ in



Exkin® PLATINUM

THERMOLITE®



Comfort light
INSULATED



R-value
3.9
ASTM F3340-18
Torso double layer zone

Thickness
6.3cm | 2½ in



Exkin® PLATINUM

THERMOLITE®



Comfort light Insulated





Comfort plus™

DUAL LAYER COMFORT

Comfort **plus** INSULATED

Comfort **plus XT** INSULATED

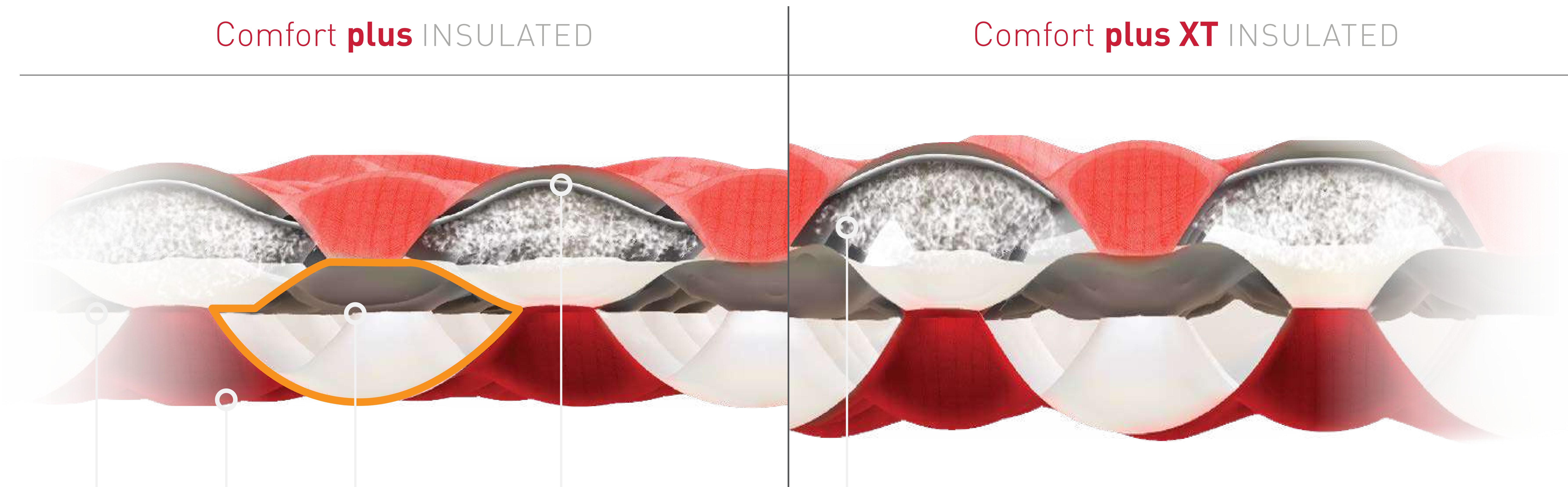

tpü 

30/40D Nylon

AIR SPRUNG CELL

Eskin PLATINUM

THERMOLITE

Comfort plus XT Insulated mats combine all the benefits of the Comfort plus Insulated but are extra thick.

Two layers of high resolution cells for all-over comfort and security—**independent chambers** allow the mat to function even if one layer is punctured.



The dual chamber design of the Comfort-Plus offers a more stable and comfortable platform than any other lightweight sleeping mat available.



Comfort Plus Insulated

Comfort plus
INSULATED



R-value
4.0
ASTM F3340-18

Thickness
6.3cm | 2½ in

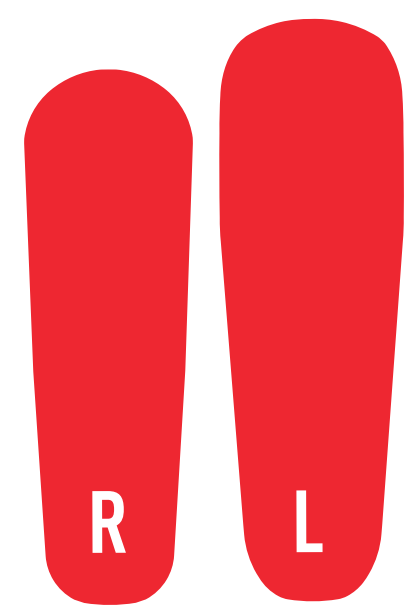

Exkin® PLATINUM

THERMOLITE®



Comfort plusXT
INSULATED

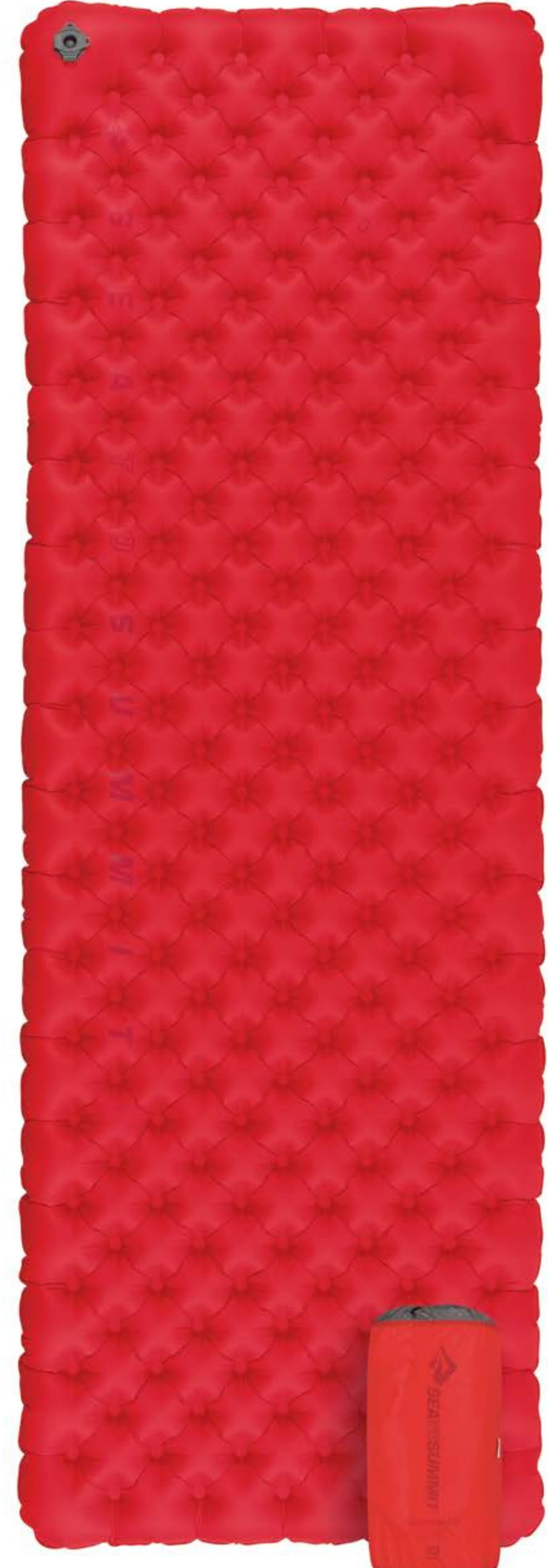

R-value
4.7
ASTM F3340-18

Thickness
8cm | 3 in



Exkin® PLATINUM

THERMOLITE®





ETHERLIGHT XT

PRODUCT NAME	CODE	SIZE	DIMENSIONS	PACKED DIMENSIONS	WEIGHT	COLOUR	RRP
Ether Light XT	AMELXTR	Regular	183 x 55cm 72.1 x 21.7 in	ø9 x 19cm ø3.5 x 7.5 in	390g 12.3 oz		
	AMELXTL	Large	198 x 64cm 78 x 25.2 in	ø10 x 22cm ø4 x 8.8 in	500g 16.4 oz		
Ether Light XT Insulated	AMELXTINS_S	Small	168 x 55cm 66.1 x 21.7 in	ø11 x 24cm ø4.5 x 9.5 in	470g 16.6 oz		
	AMELXTINS_R	Regular	183 x 55cm 72.1 x 21.7 in		490g 17.3 oz		
	AMELXTINS_L	Large	198 x 64cm 78 x 25.2 in	ø13 x 28cm ø4.8 x 11 in	625g 22 oz		
	AMELXTINS_RRW	Rectangular Reg. Wide	183 x 64cm 72.1 x 25.2 in	ø11 x 24cm ø4.5 x 9.5 in	690g 19.4 oz		
	AMELXTINS_RL	Rectangular Large	201 x 64cm 79.1 x 25.2 in	ø12 x 28cm ø4.8 x 11 in	630g 21.7 oz		
	AMELXTINS_WR	Regular	168 x 55cm 66.1 x 21.7 in	ø11 x 24cm ø4.5 x 9.5 in	495g 14.8 oz		
Ether Light XT Insulated Women's	AMELXTINS_WL	Large	183 x 64cm 72.1 x 25.2 in	ø12 x 28cm ø4.8 x 11 in	600g 18.7 oz		

ETHERLIGHT XT EXTREME

PRODUCT NAME	CODE	SIZE	DIMENSIONS	PACKED DIMENSIONS	WEIGHT	COLOUR	RRP
Ether Light XT Extreme	AMELXTEXMR	Regular	183 x 55cm 72.1 x 21.7 in	ø17.5 x 24cm ø6.9 x 9.4 in	720g 25.4 oz		
	AMELXTEXML	Large	198 x 64cm 78 x 25.2 in		950g 33.5 oz		
	AMELXTEXMRRW	Rectangular Reg. Wide	183 x 64cm 72.1 x 25.2 in	ø18.5 x 28cm ø7.3 x 11 in			
	AMELXTEXMRL	Rectangular Large	201 x 64cm 79.1 x 25.2 in		1050g 37 oz		
Ether Light XT Extreme Women's	AMELXTEXMWR	Regular	168 x 55cm 66.1 x 21.7 in	ø17.5 x 24cm ø6.9 x 9.4 in	685g 24.2 oz		
	AMELXTEXMWL	Large	183 x 64cm 72.1 x 25.2 in	ø18.5 x 28cm ø7.3 x 11 in	870g 30.7 oz		



ULTRALIGHT

PRODUCT NAME	CODE	SIZE	DIMENSIONS	PACKED DIMENSIONS	WEIGHT	COLOUR	RRP
	AMULSAS	Small	168 x 55cm 66.1 x 21.7 in	ø7 x 17cm ø2.5 x 6.8 in	345g 12.2 oz		
UltraLight Mat	AMULRAS	Regular	183 x 55cm 72.1 x 21.7 in	ø7.5 x 17cm ø3 x 6.8 in	395g 13.9 oz		
	AMULLAS	Large	198 x 64cm 78 x 25.2 in	ø7.5 x 20cm ø3 x 7.8 in	495g 17.5 oz		
	AMULINS_XS	X Small	128 x 55cm 50.4 x 21.7 in	ø9 x 23cm ø3.5 x 9 in	349g 12.3 oz		
	AMULINS_S	Small	168 x 55cm 66.1 x 21.7 in	ø9.5 x 23cm ø4 x 9 in	430g 15.2 oz		
UltraLight Insulated Mat	AMULINS_R	Regular	183 x 55cm 72.1 x 21.7 in	ø10 x 23cm ø4 x 9 in	480g 16.9 oz		
	AMULINS_L	Large	198 x 64cm 78 x 25.2 in	ø10.5 x 26cm ø4.3 x 10.3 in	595g 21 oz		
	AMULINS_WR	Regular	168 x 55cm 66.1 x 21.7 in	ø9.5 x 23cm ø3.8 x 9 in	480g 15.9 oz		
UltraLight Insulated Mat Women's	AMULINS_WL	Large	184 x 64cm 72.4 x 25.2 in	ø10 x 23cm ø4 x 9 in	580g 19.8 oz		



COMFORT LIGHT INSULATED

PRODUCT NAME	CODE	SIZE	DIMENSIONS	PACKED DIMENSIONS	WEIGHT	COLOUR	RRP
	AMCLINS_S	Small	168 x 55cm 66.1 x 21.7 in	ø12 x 24cm ø0 x 0 in	590g 20.1 oz		
Comfort Light Insulated Mat	AMCLINS_R	Regular	184 x 55cm 72.4 x 21.7 in	ø13.5 x 24cm ø4.5 x 9 in	640g 22.6 oz	●	
	AMCLINS_L	Large	201 x 64cm 79.1 x 25.2 in	ø13.5 x 27cm ø4.5 x 10.3 in	755g 26.6 oz		
	AMCLINS_WR	Regular	168 x 55cm 66.1 x 21.7 in	ø13 x 24cm ø4.3 x 9 in	585g 19.6 oz		
Comfort Light Insulated Women's	AMCLINS_WL	Large	183 x 64cm 72.1 x 25.2 in	ø13 x 27cm ø4.5 x 9 in	715g 24.2 oz	●	

COMFORT PLUS INSULATED

PRODUCT NAME	CODE	SIZE	DIMENSIONS	PACKED DIMENSIONS	WEIGHT	COLOUR	RRP
	AMCPINS_R	Regular	184 x 55cm 72.1 x 21.7 in	ø14.5 x 24cm ø4.8 x 9 in	845g 27.7 oz		
Comfort Plus Insulated Mat	AMCPINS_L	Large	201 x 64cm 79.1 x 25.2 in	ø14.5 x 27cm ø5 x 10.3 in	1045g 35.8 oz	●	
	AMCPXTINS_RRW	Rectangular Reg. Wide	183 x 64cm 79.1 x 25.2 in	ø17.5 x 28cm ø6.9 x 11 in	1185g 35.8 oz		
Comfort Plus XT Insulated	AMCPXTINS_RL	Rectangular Large	201 x 64cm 72.1 x 25.2 in	ø17 x 28cm ø6.7 x 11 in	1295g 39.3 oz	●	



SELF-INFLATING MATS

Our range of self-inflating mats provide consistent warmth along the full length of the mat in a compact and lighter, comfortable, easy-to-use package.

COMFORT



PILLOWLOCK SYSTEM

Pillow Lock attaches an Aeros pillow to mat.

FOUR WAY STRETCH FABRICS

Four way stretch fabrics better conform to your body as you sleep.

ANTI-SLIP SILICONE PRINT

Prevents your sleeping bag from slipping on the mat, or the mat from slipping on the tent floor.

EASE OF USE

REPAIR KITS

Both our Self Inflating and Air Sprung Cell mats include a small repair kit with repair patches.

MULTI-FUNCTION REVERSIBLE VALVE

Specifically designed for Self-Inflating mats.

With a simple twist, our multi-function valve prevents reinflation while rolling your mat up. Twist it back for easy one-way inflation and fine tuning.

LIGHTER WEIGHT

DELTA CORE

The design leaves a solid layer of foam to bond with the fabric across the full length of the mat, making a far more durable finish.

Delta Core design leaves extra foam directly under the sleeper, providing better insulation.



DELTA CORE-V

In our lighter models, Delta Core-V vertical coring technology is applied to remove 20% of the weight and bulk of the mat's polyurethane (PU) foam. We use sophisticated pressure-mapping data to define body contact areas which becomes the blueprint for our distinctive graduated core pattern.



DELTA CORE

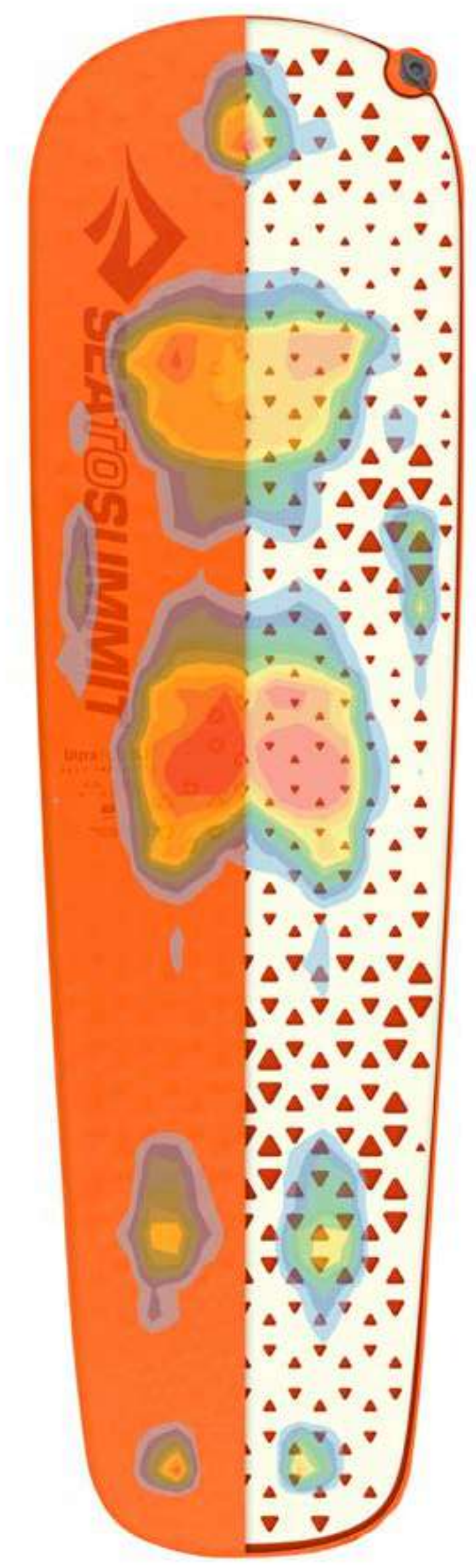

DELTA CORE-V



EXPLORE THE RANGE

DELTA CORE-V			DELTA CORE			
	<p>Ultra light S.I. SELF INFLATING</p>  	<p>Camp mat S.I. SELF INFLATING</p>  	<p>Camp plus S.I. SELF INFLATING</p>  	<p>Comfort light S.I. SELF INFLATING</p>  	<p>UPDATED</p> <p>Comfort plus S.I. SELF INFLATING</p>  	<p>UPDATED</p> <p>Comfort deluxe S.I. SELF INFLATING</p>  
<p>R-Value ASTM F3340-18</p>	 2.6  2.9	 4.2	 4.3	 3.1  3.8	 4.1  5.1	 6.5



Our lightest SI Mat that offers all of our class leading technology but with a minimal packed size.

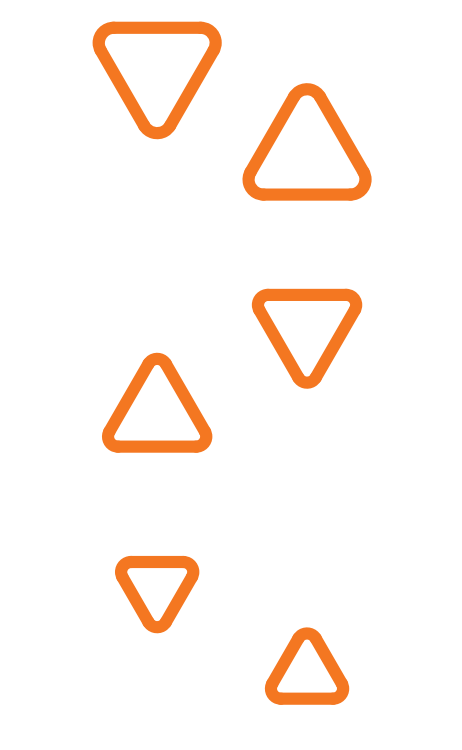

Ultra light S.I.
SELF INFLATING



R-value
2.6
ASTM F3340-18

Thickness
2.5cm | 1 in

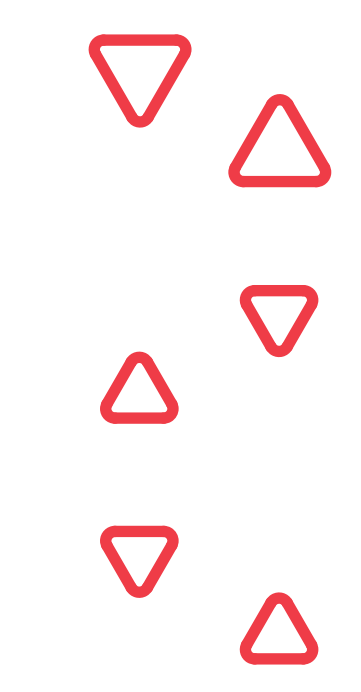

Ultra light S.I.
SELF INFLATING

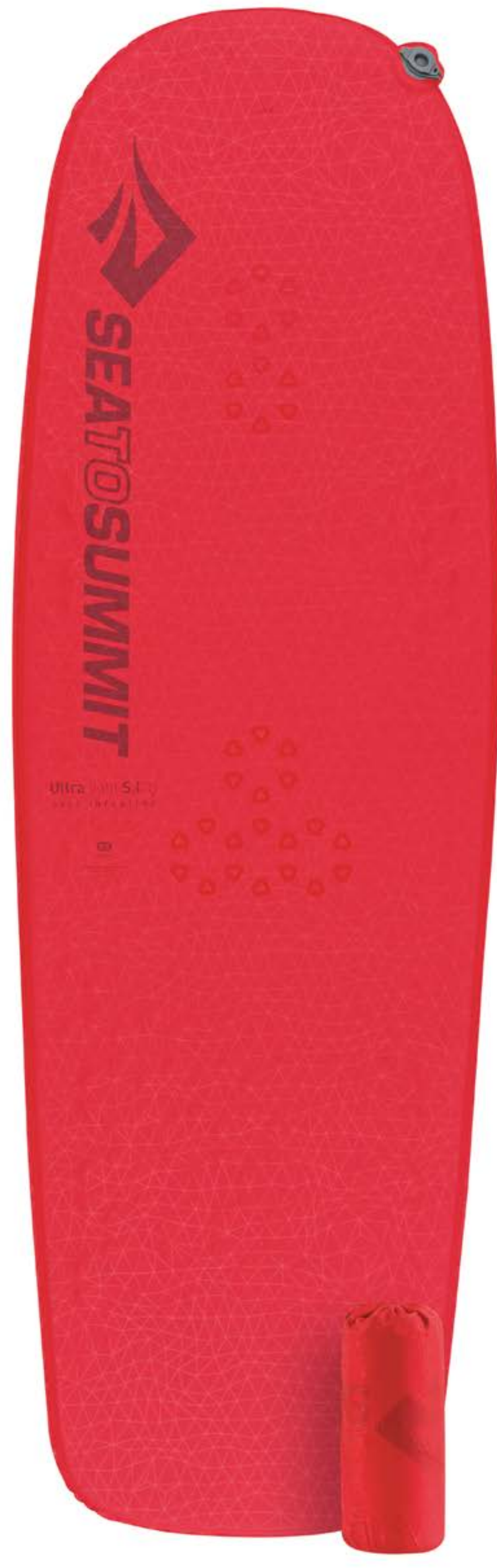

R-value
2.9
ASTM F3340-18

Thickness
2.5cm | 1 in

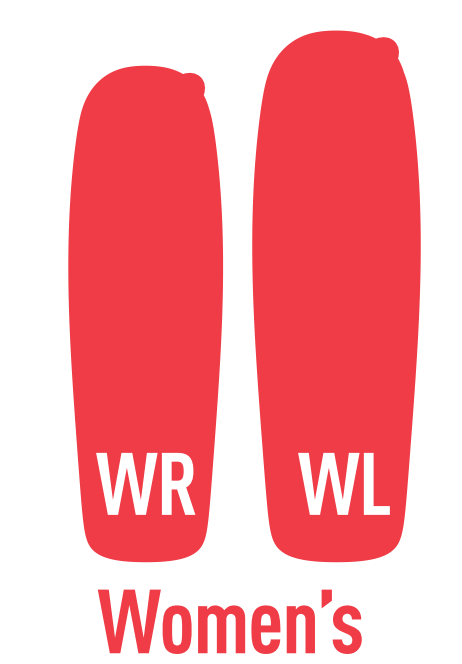



The Camp Mat series still reduce weight and bulk with our Delta Core technology, but wraps the PU foam in more durable fabrics to create great value mats that offer performance all year round.

Camp mat S.I.
SELF INFLATING



R-value
4.2
ASTM F3340-18

Thickness
3.8cm | 1½ in



Camp plus S.I.
SELF INFLATING



R-value
4.3
ASTM F3340-18

Thickness
7.5cm | 3 in

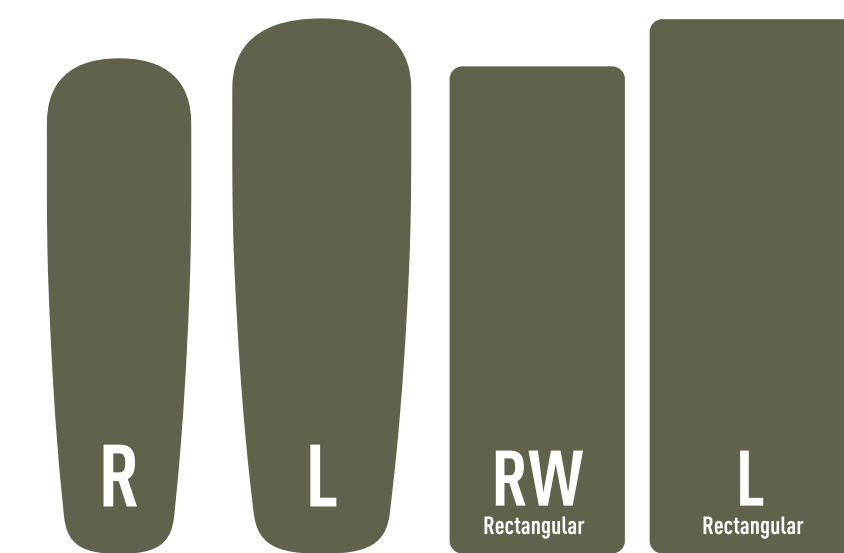



The combination of lightweight fabrics and clever construction with Delta Coring technology provides 3 season warmth and extra comfort without adding extra weight or cost.

Comfort light **S.I.**
SELF INFLATING



R-value **3.1**
ASTM F3340-18

Thickness **5cm | 2 in**

S R L

VIDEO

+

Comfort light **S.I.**
SELF INFLATING



R-value **3.8**
ASTM F3340-18

Thickness **5cm | 2 in**

WR WL
Women's

VIDEO

+





The Comfort plus S.I. with its four-way stretch top has a luxurious feel that conforms to any body shape, and the 8cm thick profile will keep you warm and comfortable regardless of how bumpy or cold the ground might be.

UPDATED

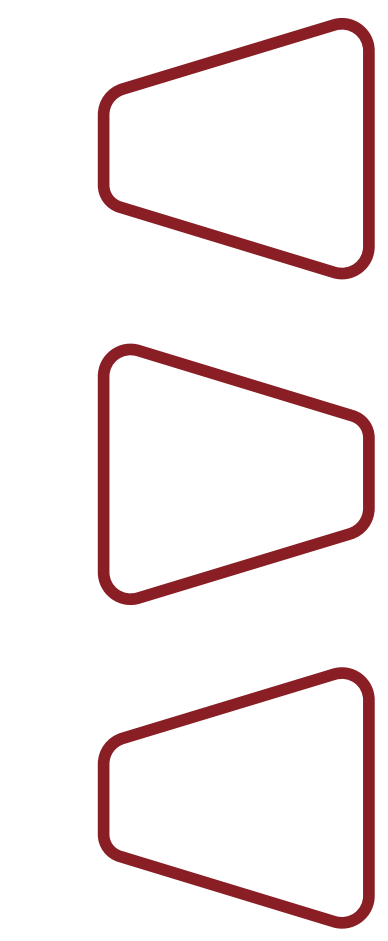

Comfort plus S.I.
SELF INFLATING



R-value
4.1
ASTM F3340-18

Thickness
8cm | 3 1/8 in

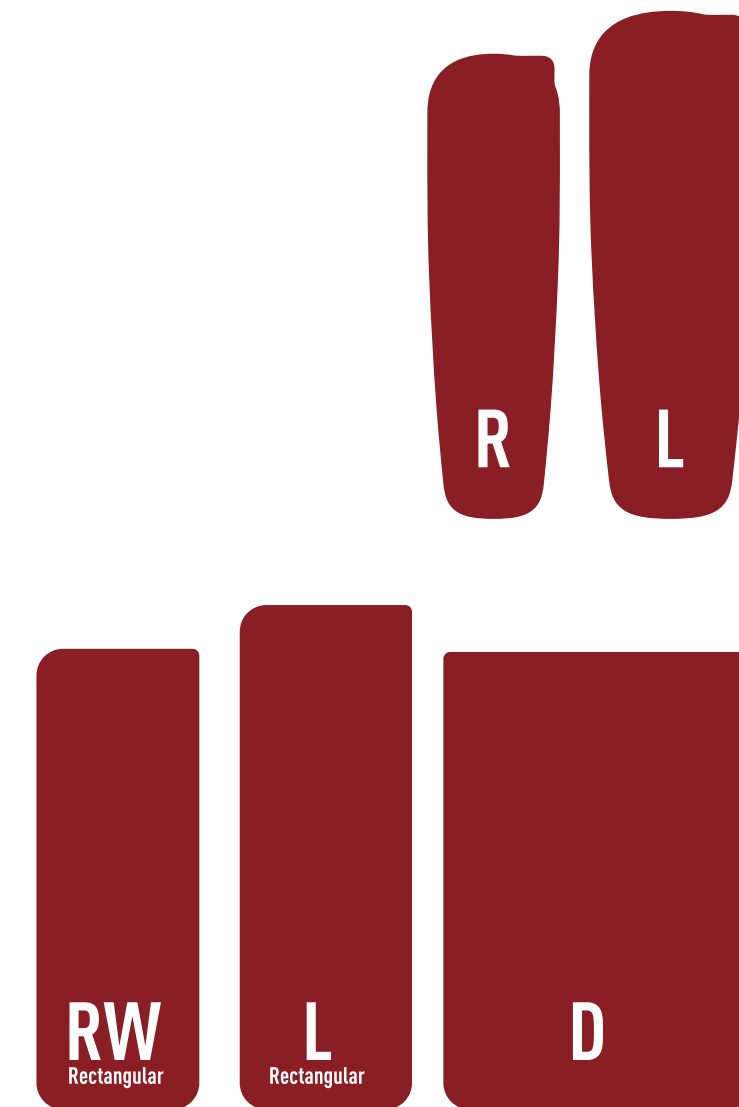

UPDATED

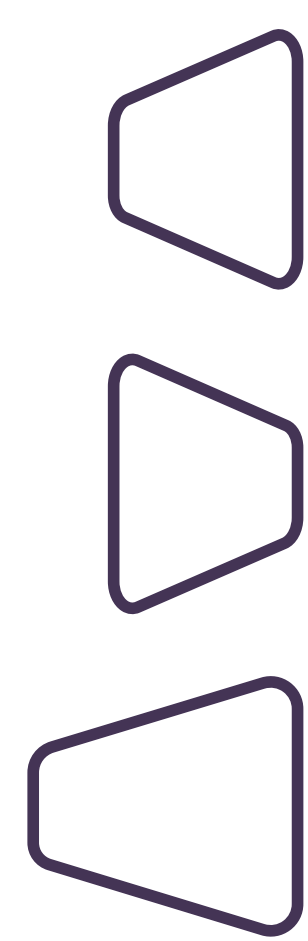

Comfort plus S.I.
SELF INFLATING



R-value
5.1
ASTM F3340-18

Thickness
8cm | 3 1/8 in





The luxurious comfort of the four way stretch fabric atop the Comfort Deluxe mat will give you a great nights sleep, and the design means that it's smaller and lighter when packed away.

UPDATED

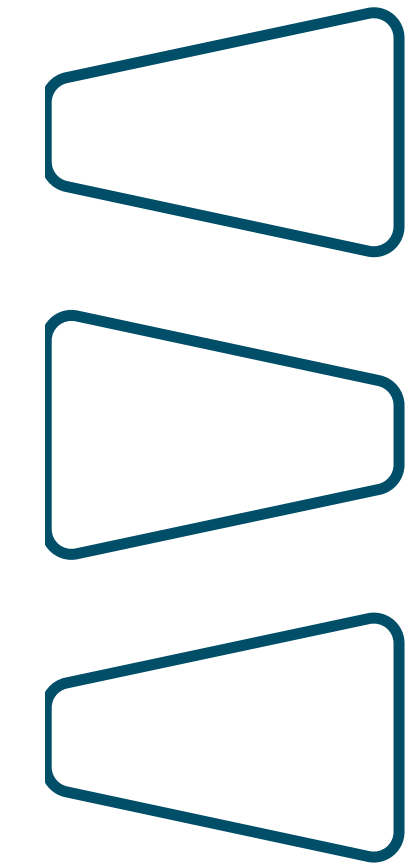

Comfort deluxe S.I.
SELF INFLATING







R-value
6.5
ASTM F3340-18

Thickness
10cm | 4 in

- RW Rectangular
- LW Rectangular
- DOUBLE
- CAMPVAN



**ULTRALIGHT S.I.**

PRODUCT NAME	CODE	SIZE	DIMENSIONS	PACKED DIMENSIONS	WEIGHT	COLOUR	RRP
 Ultralight SI	AMSIULXS	X Small	125 x 51cm 49.2 x 20.1 in	ø10.5 x 26cm ø4.3 x 11 in	395g 13.9 oz		
	AMSIULS	Small	170 x 51cm 66.9 x 20.1 in	ø13 x 26cm ø4.8 x 11 in	520g 18.3 oz		
	AMSIULR	Regular	183 x 51cm 72.1 x 20.1 in	ø13.5 x 26cm ø5 x 11 in	550g 19.4 oz		
	AMSIULL	Large	198 x 64cm 78 x 25.2 in	ø14 x 13cm ø5 x 13.5 in	720g 25.4 oz		
 Ultralight SI Women's	AMSIULWR	Regular	170 x 53cm 66.9 x 20.9 in	ø14 x 27cm ø4.8 x 11 in	545g 19.2 oz		
	AMSIULWL	Large	183 x 53cm 72.1 x 20.9 in	ø14.6 x 30cm ø4.8 x 11 in	645g 22.8 oz		

CAMP MAT S.I.

PRODUCT NAME	CODE	SIZE	DIMENSIONS	PACKED DIMENSIONS	WEIGHT	COLOUR	RRP
 Camp Mat SI	AMSIUMR	Regular	183 x 51cm 72.1 x 20.1 in	ø18.5 x 26cm ø6 x 10 in	780g 27.5 oz		
	AMSIUML	Large	198 x 64cm 78 x 25.2 in	ø19.7 x 33cm ø6.5 x 10 in	1020g 36 oz		
	AMSIUMRRW	Rect. Reg Wide	183 x 64cm 72.1 x 25.2 in	ø19.7 x 34cm ø8 x 13.5 in	1115g 39.3 oz		
	AMSIUMRL	Rect. Large	198 x 64cm 78 x 25.2 in	ø20.4 x 34cm ø8.5 x 13.5 in	1180g 41.6 oz		
 Camp Plus SI	AMSIUPLR	Regular	183 x 51cm 72.1 x 20.1 in	ø20.4 x 26cm ø8 x 10.2 in	880g 31 oz		
	AMSIUPLL	Large	198 x 64cm 78 x 25.2 in	ø21.6 x 33cm ø8.5 x 13 in	1185g 41.8 oz		
	AMSIUPLRRW	Rect. Reg Wide	183 x 64cm 72.1 x 25.2 in	ø20.4 x 34cm ø8 x 13.4 in	1220g 43 oz		
	AMSIUPLRL	Rect. Large	201 x 64cm 79.1 x 25.2 in	ø21.6 x 34cm ø8.5 x 13.4 in	1355g 47.8 oz		

**COMFORT LIGHT S.I.**

PRODUCT NAME	CODE	SIZE	DIMENSIONS	PACKED DIMENSIONS	WEIGHT	COLOUR	RRP
Comfort Light SI	AMSICLS	Small	170 x 51cm 66.9 x 20.1 in	ø14.5 x 26cm ø5.8 x 10 in	595g 21 oz		
	AMSICLR	Regular	183 x 51cm 72.1 x 20.1 in	ø15.3 x 26cm ø6 x 10 in	650g 22.9 oz		
	AMSICLL	Large	198 x 64cm 78 x 25.2 in	ø16.5 x 33cm ø6 x 13 in	880g 31 oz		
Comfort Light SI Women's	AMSICLWR	Regular	170 x 53cm 66.9 x 20.9 in	ø16.5 x 27cm ø6.3 x 8.3 in	665g 19.2 oz		
	AMSICLWL	Large	183 x 58cm 72.1 x 22.8 in	ø17.8 x 30cm ø6.5 x 10.8 in	775g 27.3 oz		

COMFORT PLUS S.I.

PRODUCT NAME	CODE	SIZE	DIMENSIONS	PACKED DIMENSIONS	WEIGHT	COLOUR	RRP
Comfort Plus SI	ASM2067-01051908	Regular	183 x 51cm 72.1 x 20.1 in	ø19.1 x 26cm ø7 x 10 in	970g 31.6 oz		
	ASM2067-01061909	Large	198 x 64cm 78 x 25.2 in	ø20.4 x 33cm ø7.5 x 13 in	1300g 42.2 oz		
	ASM2067-01321911	Rect. Large	201 x 64cm 79.1 x 25.2 in	ø21.6 x 34cm ø8.5 x 13.5 in	1470g 48.3 oz		
	ASM2067-01291910	Rect. Regular Wide	183 x 64cm 72.1 x 25.2 in		1380g 44.6 oz		
	ASM2067-01221912	Double	183 x 128cm 72.1 x 50.4 in	ø24.8 x 66cm ø9.8 x 26 in	2635g 88.2 oz		
Comfort Plus SI Women's	ASM2067-05331513	Regular	170 x 53cm 66.9 x 20.9 in	ø20.4 x 27cm ø6.3 x 8.3 in	950g 32.6 oz		
	ASM2067-05341514	Large	183 x 58cm 72.1 x 22.8 in	ø21.6 x 30cm ø6.5 x 10.8 in	1130g 38.6 oz		

COMFORT DELUXE S.I.

PRODUCT NAME	CODE	SIZE	DIMENSIONS	PACKED DIMENSIONS	WEIGHT	COLOUR	RRP
Comfort Deluxe SI	ASM2065-01291605	Regular Wide	183 x 64cm 72.1 x 25.2 in	ø20.4 x 64cm ø8 x 25.2 in	1995g 64.9 oz		
	ASM2065-01461606	Large Wide	201 x 76cm 79.1 x 29.9 in	ø22.3 x 76cm ø8.8 x 29.9 in	2645g 85 oz		
	ASM2065-01221607	Double	201 x 132cm 79.1 x 52 in	ø32.5 x 65cm ø12.8 x 25.6 in	4445g 149 oz		
	ASM2065-01361608	Camper Van	201 x 115cm 79.1 x 45.3 in	ø30 x 60cm ø11.8 x 23.6 in	3650g 128.8 oz		



MAT COUPLER KIT LOOPS

Stop sleeping in the crack—secure your two Sea to Summit mats together.

FEATURES

- Simple to use
- Low profile design stays flat for comfortable positioning



AIRSTREAM PUMP SACK

Storage by day, pump by night—inflate your air mat in seconds.

FEATURES

- Works with the multi-function valve on both ASC and SI mats.

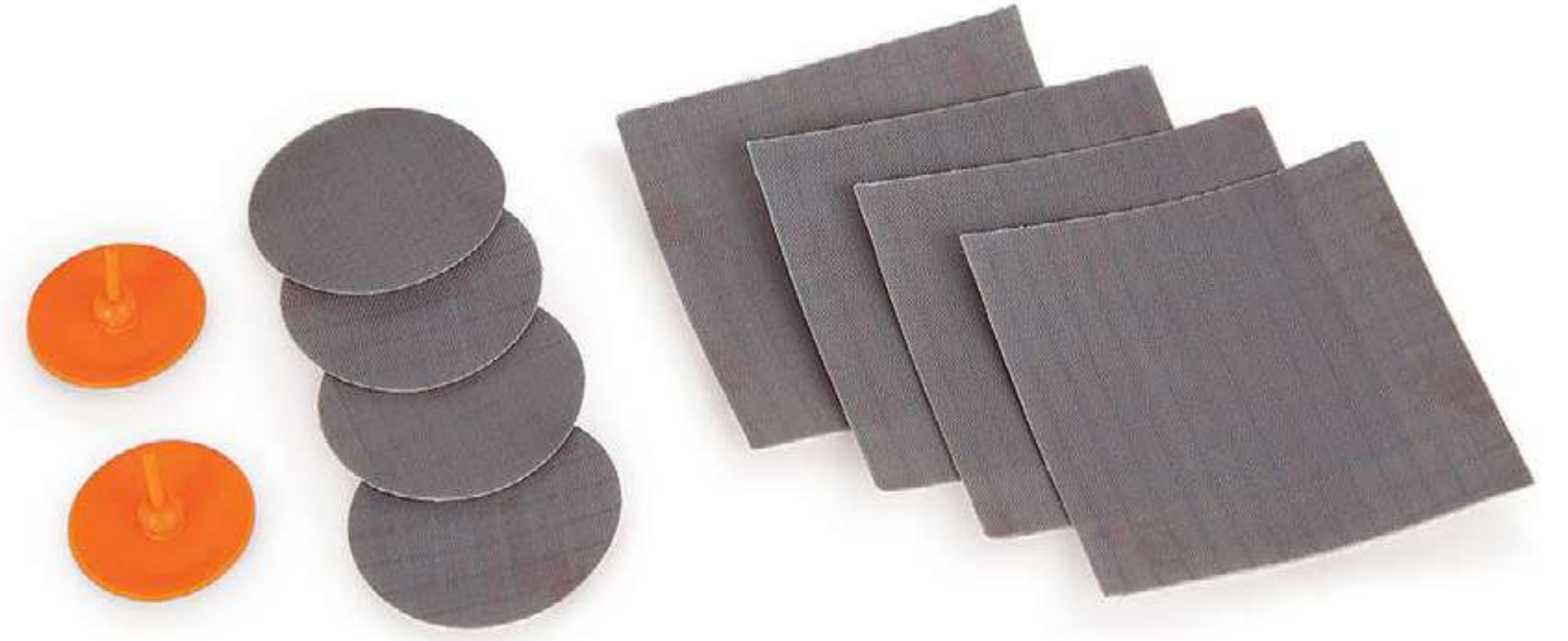

AIR MAT REPAIR KIT

Punctures happen—repair your Sea to Summit air mat with ease.





AIR CHAIR

Air mat transformer: chair by day and sleeping mat by night

FEATURES

- Converts your Sea to Summit Sleeping Mat into a comfortable camp chair
- Reinforced pole sleeve with puncture-proof synthetic rubber caps for added strength
- Upgraded side release Field Repair Buckles with stainless steel pin on side straps for durability and high break-strength
- Durable 70D base with 2000mm waterhead protects your mat from rough or wet ground

SIZES

R / L

COLOUR

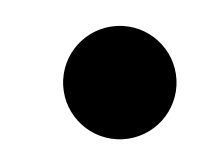



SLEEPING MAT ACCESSORIES

PRODUCT NAME	CODE	SIZE	DIMENSIONS	WEIGHT	MATERIALS	RRP
 Airstream Pump Sack	AMASD		63 x 26 x 20cm 24.8 x 10.2 x 7.9 in	62g 1.7 oz	15D PU-coated, siliconised Nylon	
 Mat Coupler Kit Loops	AMCK		270 x 2cm 106.3 x 0.8 in	17g 0.5 oz	Nylon	
 Air Mat Repair Kit	AMRK		5 x 5cm 2 x 2 in	10g 0.4 oz	100% Nylon, 3M glue	
 Air Chair	AMAIRCR	Regular	53 x 45cm 20.8 x 17.7 in	253g 8.1 oz	70D PU-coated Nylon, 30D PU-coated, siliconised CORDURA® Nylon	
	AMAIRCL	Large	60 x 48cm 23.6 x 18.9 in	260g 9.9 oz		



AIR SEATS

So packable you won't notice the addition to your bag, but so useful you'll never leave home without it. Our Air Seat is the perfect way to add a little comfort to whatever you're sitting on. Available in both a standard and an insulated version.



FEATURES

- Super-fast inflate and deflate with our multi-function low profile mini-valve

COLOURS



S.I. SEAT

A compact seat companion that quickly inflates to provide extra comfort and support for any adventure.



FEATURES







- Our patented low-profile multi-function mini-valve provides fast inflate, deflate and easy fine-tuning

COLOURS





SEATS

PRODUCT NAME	CODE	DIMENSIONS	COLLAPSED DIMENSIONS	WEIGHT	COLOUR	RRP
 Air Seat	AMAS	38 x 28 x 6cm 15 x 11 x 1.9 in	12 x 10 x 3cm 4.72 x 3.93 x 1.18 in	70g 2.5 oz		
 Air Seat Insulated	AMASINS			80g 2.8 oz		
 Self Inflating Seat	AMSIDS	40 x 30 x 3.8cm 12 x 16 x 1.5 in	ø7.5 x 17cm ø3 x 6.7 in	104g 4.2 oz		



PILLOWS

Ultralight pillows to help you sleep better.





EXPLORE THE RANGE

AEROS PILLOWS

PREMIUM



AEROS PREMIUM DELUXE



AEROS PREMIUM



AEROS PREMIUM TRAVELLER



AEROS PREMIUM LUMBAR SUPPORT

ULTRALIGHT



AEROS ULTRALIGHT DELUXE



AEROS ULTRALIGHT



AEROS ULTRALIGHT TRAVELLER

DOWN



AEROS DOWN

ACCESSORIES



AEROS PILLOW CASE

FOAM PILLOWS



FOAM CORE PILLOW



AEROS PILLOWS

Whether in transit or the back country, our Aeros range of lightweight and compact inflatable pillows will award you a comfortable sleep.



OUR AEROS PILLOWS FEATURE:

MULTI-FUNCTION MINI VALVE

Featuring our unique mini-valve for easy inflation, deflation and fine tuning.

LIGHTWEIGHT AND COMPACT

Often forgotten, always appreciated —they're so small and light the only decision to make is which one to choose.

CONVENIENT STORAGE

Comes with a stuff sack or zippered pouch to make packing and storage so much easier.

PILLOWLOCK COMPATIBLE

Easily secure your Aeros pillow to your Sea to Summit mat for a slip-free sleep—PillowLock patches are included with all our mats.





AEROS PREMIUM

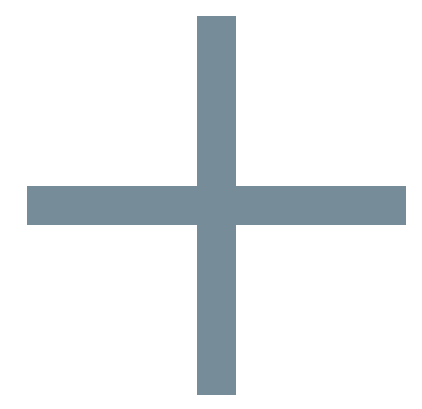

OUR AEROS PREMIUM RANGE FEATURES:

LUXURIOUS FEEL

Brushed, 50D polyester, stretch-knit face fabric for soft hand feel.

COMFORTABLE

Synthetic fill between pillow case and TPU bladder increases comfort and wicks away perspiration.



AEROS PREMIUM DELUXE

Dream big; pack small with this luxurious, lightweight and surprisingly compact full-size pillow.

COLOURS    



AEROS PREMIUM

A luxurious, high-performance pillow without the weight and bulk. Perfect for travel and camping where you can risk a couple more grams for a great night's sleep.

FEATURES

- Scalloped bottom edge centres the pillow over your shoulder no matter whether you are sleeping on your back, side or sitting upright in a chair

SIZES R / L COLOURS    





AEROS PREMIUM TRAVELLER

Take your transit comfort to a new level with our packable Premium Traveller Pillow.

FEATURES

- Adjustable neck closure for additional support
- Ergonomic shape and enlarged ends reduce the need to bend your neck for support
- Narrows at the centre to fit snugly between your neck and headrest

COLOURS



AEROS PREMIUM LUMBAR SUPPORT

Keep your lower back supported and comfortable in the air, at your desk or behind the wheel.

FEATURES

- Includes an adjustable webbing strap to secure the pillow in place

COLOURS





AEROS ULTRALIGHT



OUR AEROS ULTRALIGHT RANGE FEATURES:

LIGHT AND COMPACT

Made from 20D laminated polyether to be very light and compact.

DURABLE

Laminated with abrasion-resistant high strength TPU with durable RF-welded construction.

QUICK AND EASY

Inflate pillow in a couple of breaths with the multi-function mini-valve.

COMFORTABLE

Stretch-knit fabric creates a more comfortable user experience.



AEROS ULTRALIGHT DELUXE

Extremely comfortable, lightweight and surprisingly compact full-size pillow.

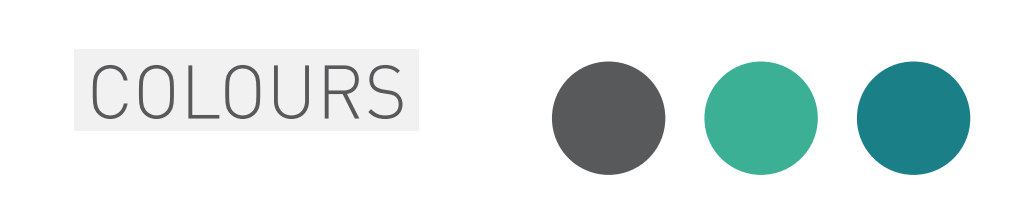

AEROS ULTRALIGHT

Light, compact and comfortable support —the best 60g you'll ever add to your pack.

FEATURES

- Scalloped bottom edge centres pillow over your shoulders whether sleeping on your back, side, or upright in a chair

SIZES R / L





AEROS ULTRALIGHT TRAVELLER

Add a little extra comfort to our next transit with this ultralight neck pillow.

FEATURES

- Adjustable neck closure for additional support
- Ergonomic shape and enlarged ends reduce the need to bend your neck for support
- Narrows at the centre to fit snugly between your neck and headrest

COLOURS



AEROS DOWN

Light, warm and comfortable, our Aeros Down Pillow is the lightest fully-featured down pillow on the market.

FEATURES

- Premium down cushion-top for comfort and warmth

SIZES R / L / DLX

COLOURS



AEROS PILLOW CASE

Aeros Pillow Cases go over the top of our Aeros Pillows for easy washing, or for use with spare clothes or a down jacket as a minimalist pillow alternative.

FEATURES

- A hidden zipper keeps your pillow securely contained

SIZES R / L

COLOURS





FOAM CORE PILLOW

Compact comfort for the outdoors, our Foam Core Pillow offers the traditional feel of your favourite pillow at home. Firmly stuffed with upcycled foam off-cuts from our SI Sleeping Mats, our Foam Core Pillow is compressed and stored with a simple hook-and-loop fastener. Styled to perform just like your favourite pillow at home, our Foam Core Pillow is the perfect compact camp pillow.

FEATURES

- Compresses to less than 20% of its maximum size

SIZES R / L / DLX

COLOURS  



Handy integrated pocket



Stuffed with upcycled foam off-cuts



Rolling hook-and-loop closure





AEROS PREMIUM PILLOWS

PRODUCT NAME	CODE	SIZE	DIMENSIONS	COLLAPSED DIMENSIONS	WEIGHT	MATERIALS	PILLOWLOCK COMPATIBLE	COLOUR	RRP
Aeros Premium Deluxe	APILPREMDLX	Deluxe	36 x 56 x 14cm 22.1 x 14.2 x 5.5 in	12 x 11 x 5.5cm 4.72 x 4.33 x 2.16 in	195g 6.9 oz	50D polyester knit fabric, TPU bladder, polyfill under contact surface			
Aeros Premium	APILPREMR	Regular	34 x 24 x 11cm 13.4 x 9.5 x 4.3 in	ø7 x 8.5cm ø2.8 x 3.3 in	79g 2.8 oz				
Aeros Premium Traveller	APILPREMYHA	Traveller	39 x 29 x 11cm 15.4 x 11.4 x 4.3 in	9 x 7 x 4.5cm 3.54 x 2.75 x 1.77 in	93g 3.3 oz				
Aeros Premium Lumbar Support	APILPREMLMB	Lumbar	42 x 28 x 11cm 16.5 x 11 x 4.3 in	12.5 x 7.5 x 5cm 4.92 x 2.95 x 1.96 in	136g 4.8 oz				

AEROS ULTRALIGHT PILLOWS

PRODUCT NAME	CODE	SIZE	DIMENSIONS	COLLAPSED DIMENSIONS	WEIGHT	MATERIALS	PILLOWLOCK COMPATIBLE	COLOUR	RRP
Aeros Ultralight Deluxe	APILULDLX	Deluxe	36 x 56 x 14cm 22.1 x 14.2 x 5.5 in	12 x 10 x 3cm 4.72 x 3.93 x 1.18 in	130g 4.6 oz	Laminated 20D polyester stretch knit and high strength TPU			
Aeros Ultralight	APILULR	Regular	36 x 26 x 12cm 14.2 x 10.2 x 4.7 in	ø5.5 x 7.5cm ø2.2 x 2.9 in	60g 2.1 oz				
Aeros Ultralight Traveller	APILULYHA	Traveller	39 x 29 x 11cm 15.4 x 11.4 x 4.3 in	9 x 7 x 4.5cm 3.54 x 2.75 x 1.77 in	70g 2.5 oz				



AEROS DOWN

PRODUCT NAME	CODE	SIZE	DIMENSIONS	COLLAPSED DIMENSIONS	WEIGHT	MATERIALS	PILLOWLOCK COMPATIBLE	COLOUR	RRP
Aeros Down	APILDOWNR	Regular	34 x 24 x 12cm 13.4 x 9.5 x 4.7 in	ø6.5 x 8cm ø2.6 x 3.1 in	70g 2.5 oz	50D polyester knit fabric, TPU bladder, 10D Nylon upper face fabric, quality down filling			
	APILDOWNL	Large	42 x 28 x 12cm 16.5 x 11 x 4.7 in	ø7 x 9cm ø2.8 x 3.5 in	95g 3.4 oz				
	APILDOWNDLX	Deluxe	59 x 38 x 12cm 23.2 x 15 x 4.7 in	ø8 x 14cm ø3.1 x 5.5 in	190g 6.7 oz				

AEROS ACCESSORIES

PRODUCT NAME	CODE	SIZE	DIMENSIONS	COLLAPSED DIMENSIONS	WEIGHT	MATERIALS	PILLOWLOCK COMPATIBLE	COLOUR	RRP
Aeros Pillow Case	APILCASER	Regular	36 x 29 x cm 14.2 x 12.6 x 0 in	ø4.5 x 6cm ø1.8 x 2.4 in	31g 1.1 oz	Polyester			
	APILCASEL	Large	44 x 32 x cm 17.3 x 11.4 x 0 in	ø5.5 x 6cm ø2.2 x 2.4 in	42g 1.5 oz				
	APILCASEYHA	Traveller	39 x 29 x cm 16.1 x 11.4 x 0 in		39g 1.4 oz				

FOAMCORE PILLOWS

PRODUCT NAME	CODE	SIZE	DIMENSIONS	COLLAPSED DIMENSIONS	WEIGHT	MATERIALS	PILLOWLOCK COMPATIBLE	COLOUR	RRP
FoamCore Pillow	APILFOAMR	Regular	34 x 24 x 13cm 13.4 x 9.5 x 5.1 in	ø10 x 27cm ø3.9 x 10.6 in	220g 7.8 oz	50D polyester knit fabric, polyfill under contact surface, PU foam			
	APILFOAML	Large	42 x 30 x 13cm 16.5 x 11.8 x 5.1 in	ø11 x 32cm ø4.3 x 12.6 in	300g 10.6 oz				
	APILFOAMD LX	Deluxe	56 x 36 x 15cm 22.1 x 14.2 x 5.9 in	ø12 x 37cm ø4.7 x 14.6 in	450g 15.9 oz				



HAMMOCKS

Hang happy and free with our range of technical hammocks.





EXPLORE THE RANGE

HAMMOCK SETS



PRO
HAMMOCK SET



ULTRALIGHT
HAMMOCK SET



JUNGLE
HAMMOCK SET

HAMMOCK ACCESSORIES



JUNGLE HAMMOCK TARP



HAMMOCK TARP



HAMMOCK BUG NET



HAMMOCK TREE PROTECTOR

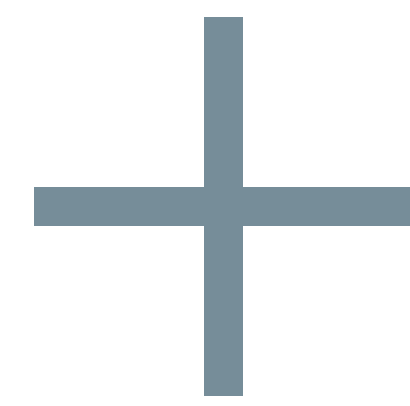

OUR HAMMOCK SETS FEATURE:

STRONG AND DURABLE

Webbing loop bar-tacked five times at each end for added security.

LIGHTWEIGHT AND BREATHABLE

Highly breathable Nylon fabrics that are incredibly strong for their weight.

QUICK AND EASY

Quick-connect buckle system provides super fast set-up and adjustment.

CONVENIENT STORAGE

A water resistant compression sack made from 30D Ultra-Sil fabric for minimising space when packed away.

ALL-IN-ONE STORAGE

Suspension Straps are included with every set, and neatly pack away in the compression sack.

HAMMOCK SETS

Lightweight, strong and easy to use, these are the Hammocks that you want when you're moving around and setting up in different locations on an adventure. Our hammock sets use an innovative buckle system that makes them super-fast to set up and adjust, while technical fabrics and included compression sacks mean they take up minimal space in your pack.

Includes everything you need to get strung up to hang out.





PRO HAMMOCK SET

The perfect hammock to take with you on globetrotting adventures or backcountry hikes.

SIZES SINGLE / DOUBLE

COLOURS



ULTRALIGHT HAMMOCK SET

Whisper-light, impressive strength to ratio and a tiny pack size.

SIZES SINGLE / SINGLEXL

COLOURS





JUNGLE HAMMOCK SET

The jungle hammock has been designed to cope with inclement weather and invasive insects. An Ultra-Sil sleeve keeps the hammock dry when setting up or taking down in the rain, while the monofilament 'no-see-um' mesh will provide a bug-free suspended sleep.

FEATURES

- Drip guard stops rain running down the webbing and saturating hammock body
- 150cm zip access with two sliders and custom T-bars for ease of use

COLOUR 



JUNGLE HAMMOCK TARP

Designed to work with the specific attachment points of the Jungle Hammock, you now have a system that provides shelter from the elements as well as insects.

FEATURES

- Ships with 6 adjustable guy lines
- Siliconised outer surface with 2000mm waterhead

COLOURS 



30D ULTRA-SIL™





HAMMOCK TARP

Remain high and dry without adding excess weight or bulk to your lightweight and compact hammock setup.

FEATURES

- Five strong and durable tie-out points each hold the tip of a trekking pole
- Asymmetric design reduces weight while still providing multiple setup options

COLOURS



HAMMOCK BUG NET

Easy setup and effective protection from bugs for your hammock.

FEATURES

- Large right-angle zip opens wide for easy access
- Enjoy the view with high-visibility black mesh
- Uninterrupted star-gazing

TRIM COLOUR



HAMMOCK TREE PROTECTOR

Protect our environment with these easy-to-use hammock tree protectors.

FEATURES

- Compact and light: fits inside hammock compression bag
- Wider webbing spreads the weight of the hammock across a broader area, lessening the potential for damage to tree bark





HAMMOCK SETS

PRODUCT NAME	CODE	SIZE	DIMENSIONS	COLLAPSED DIMENSIONS	WEIGHT	MATERIALS	COLOUR	RRP
Pro Hammock Set	AHAMSETS	Single	300 x 150cm 9'10" x 4'11"	ø10 x 17cm ø4.3 x 9 in	560g 19.7 oz	70D ripstop Nylon fabric, high tenacity 15mm polyester webbing suspension straps, steel buckles		
	AHAMSETD	Double	300 x 150cm 9'10" x 6'2"		670g 23.6 oz			
Ultralight Hammock Set	AHAMSETULS	Single	260 x 120cm 8'6" x 4'	ø9 x 14cm ø3.5 x 8 in	140g 7.8 oz	20D monofilament Nylon 66 fabric, 0.8mm Dyneema non-stretch polyester blend webbing, 6-series aluminium buckles		
	AHAMSETULXLS	Single XL	300 x 150cm 9'10" x 4'11"		205g 9.7 oz			
Jungle Hammock Set	AHAMJNGOL		260 x 145cm 8'6" x 4'9"	ø12 x 20cm ø4.3 x 8 in	775g 27 oz	70D ripstop Nylon, no-see-um monofilament Nylon-6 mesh, Dyneema webbing, 6061 aluminium buckles		

HAMMOCK ACCESSORIES

PRODUCT NAME	CODE	DIMENSIONS	COLLAPSED DIMENSIONS	WEIGHT	MATERIALS	COLOUR	RRP
Jungle Hammock Tarp	AHAMJNGTARP	280 x 178cm 9'10" x 6'2"	ø12 x 30cm ø4.3 x 8 in	450g 16 oz	30D Ultra-Sil siliconised CORDURA® Nylon fabric		
Hammock Tarp	AHAMTARP	360 x 280cm 141.7 x 110.2 in	ø8 x 19cm ø3.2 x 7.5 in	350g 12.8 oz	15D PU coated, siliconised Nylon		
Hammock Bug Net	AHAMBUG	295 x 120 x 80cm 116.1 x 47.2 x 31.5 in	ø11 x 21cm ø4.3 x 8.3 in	380g 13.4 oz	Polyester mesh		
Hammock Tree Protector	AHAMTP	150 x 3.8cm 59.1 x 1.5 in	ø9.5 x 4cm ø3.5 x 2 in	135g 4.8 oz	Polyester webbing, steel buckles		

CAMP KITCHEN



CAMP CLEAN UP



DINNERWARE

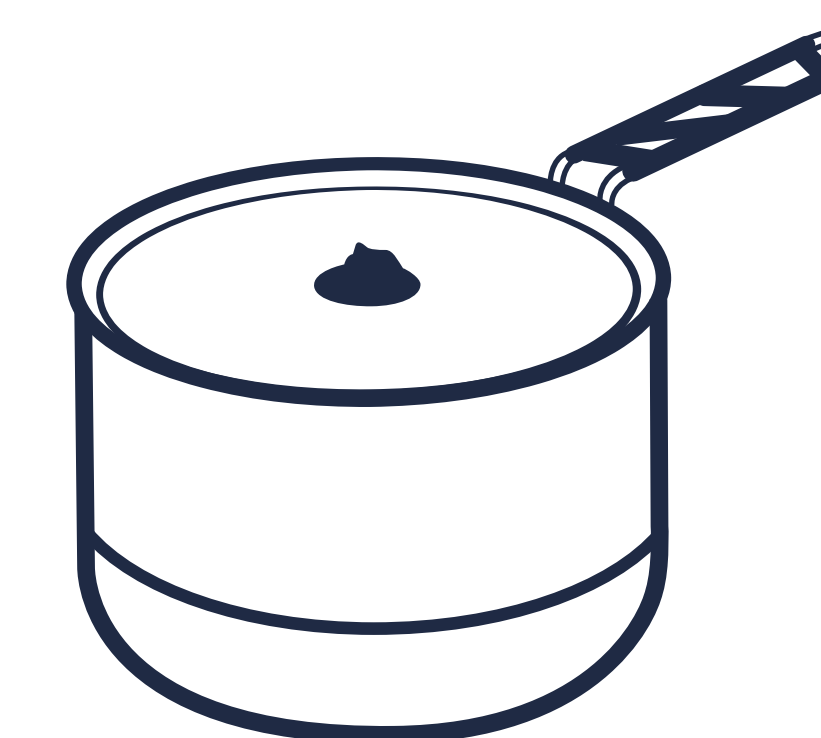

COOKWARE

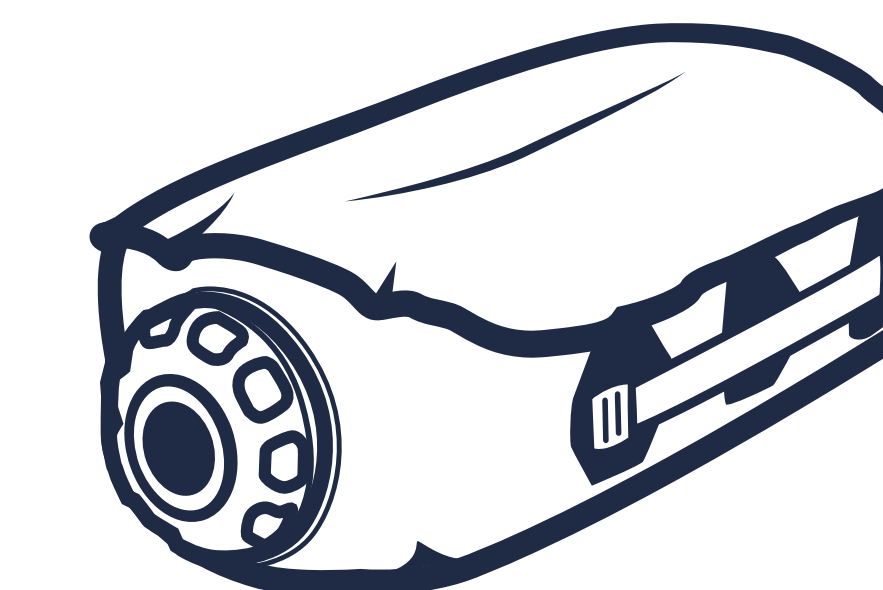

WATER TRANSPORT



CAMP CLEAN UP

Often overlooked but essential to any camp kitchen system. Our range of camp kitchen clean up solutions make it easy to keep your camp clean and neat with minimal impact on the environment.

Makes getting clean almost as much fun as getting dirty.





EXPLORE THE RANGE

CAMP CLEAN UP



CAMP KITCHEN
POT SCRUBBER & SOAP



Ultra-Sil KITCHEN SINK



Ultra-Sil FOLDING BUCKET



TRASH DRY SACK



CAMP KITCHEN
CLEAN-UP KIT



KITCHEN SINK



FOLDING BUCKET



NEW



CAMP KITCHEN POT SCRUBBER & SOAP

Palm-sized polypropylene scrubber with Nylon bristles, an integrated scraper and 50ml bottle of our concentrated and biodegradable Wilderness Wash.

2 PIECE SET



NEW



CAMP KITCHEN CLEAN-UP KIT

A convenient, lightweight all-in-one washing kit for your camp kitchen.

6 PIECE SET

INCLUDES

- Pot Scrubber
- 50ml Wilderness Wash
- 10L Kitchen Sink
- Double sided Wash Cloth
- DryLite Dish Towel
- Nylon Zip Pouch





Ultra-Sil KITCHEN SINK

Small enough to fit in a pocket and light enough to barely leave a trace on a set of scales.

SIZES 10L

30D ULTRA-SIL™



KITCHEN SINK

Now you can take everything on your next camping adventure—including a collapsible Kitchen Sink that really works!

FEATURES

- Stainless steel stiffening ring prevents sink from tipping over or collapsing when full
- For use with hot water (up to 60°C) and detergent

SIZES 5L / 10L / 20L

70D WATERPROOF FABRIC





Ultra-Sil FOLDING BUCKET

Ultra-lightweight collapsible bucket for carrying water.

FEATURES

- 10L capacity—ideal for transporting water back to camp
- Not freestanding

SIZES 10L

30D ULTRA-SIL™



TRASH DRY SACK

The outdoors is not a garbage can—pack out your rubbish cleanly and neatly with this specially designed roll-top dry sack.

FEATURES

- Waterproof, non-wicking roll-top closure for mess-free carrying
- Line with (biodegradable) garbage bag for easy cleaning and disposal
- Minimum garbage bag size: 40 x 60cm



70D WATERPROOF FABRIC



FOLDING BUCKET

Completely collapsible lightweight yet durable free-standing bucket.

FEATURES

- Free-standing on level surfaces
- Additional handle on base for easy pouring
- Fully welded construction

SIZES 10L / 20L







210D WATERPROOF FABRIC

420D WATERPROOF FABRIC





CLEAN UP SOLUTIONS

PRODUCT NAME	CODE	SIZE	DIMENSIONS	WEIGHT	RRP
 Camp Kitchen Pot Scrubber & Soap	ACK011071-120105	2 piece set	8 x 6.5 x 3cm 3.1 x 2.6 x 1.2in	95g 3.4oz	
 Camp Kitchen Clean-Up Kit	ACK011071-122103	6 piece set	13 x 3 x 21cm 5.1 x 1.2 x 8.3in (packed)	270g 9.5oz	
 Ultra-Sil Kitchen Sink	AUSSINK10	10L	ø37 x 11cm ø14.6 x 4.3 in	42g 1.5 oz	
	ASINK5	5L	ø22 x 15cm ø8.7 x 5.1 in	98g 3.5 oz	
 Kitchen Sink	ASINK10	10L	ø30 x 13cm ø11.8 x 5.1 in	127g 4.5 oz	
	ASINK20	20L	ø40 x 20cm ø15.8 x 7.9 in	188g 6.6 oz	
 Ultra-Sil Folding Bucket	AUSFB10	10L	ø20 x 25cm ø7.9 x 9.8 in	23g 1.4 oz	
	AFB10	10L	ø22 x 26cm ø8.7 x 10.2 in	80g 2.8 oz	
 Folding Bucket	AFB20	20L	ø27 x 34cm ø10.6 x 13.4 in	110g 3.9 oz	
 Trash Dry Sack	ATRASHDS	10L	44 x 34 x 5cm 17.3 x 13.4 x 2 in	100g 3.5 oz	



DINNERWARE

We know meals are an important part of your journey. That's why our dinnerware is specifically designed for use on adventures: Rugged yet light, ergonomic to use without any unnecessary bulk.



BPA FREE



EXPLORE THE RANGE

CUTLERY + UTENSILS

DINNERWARE



ALPHA CUTLERY



DELTA CUTLERY

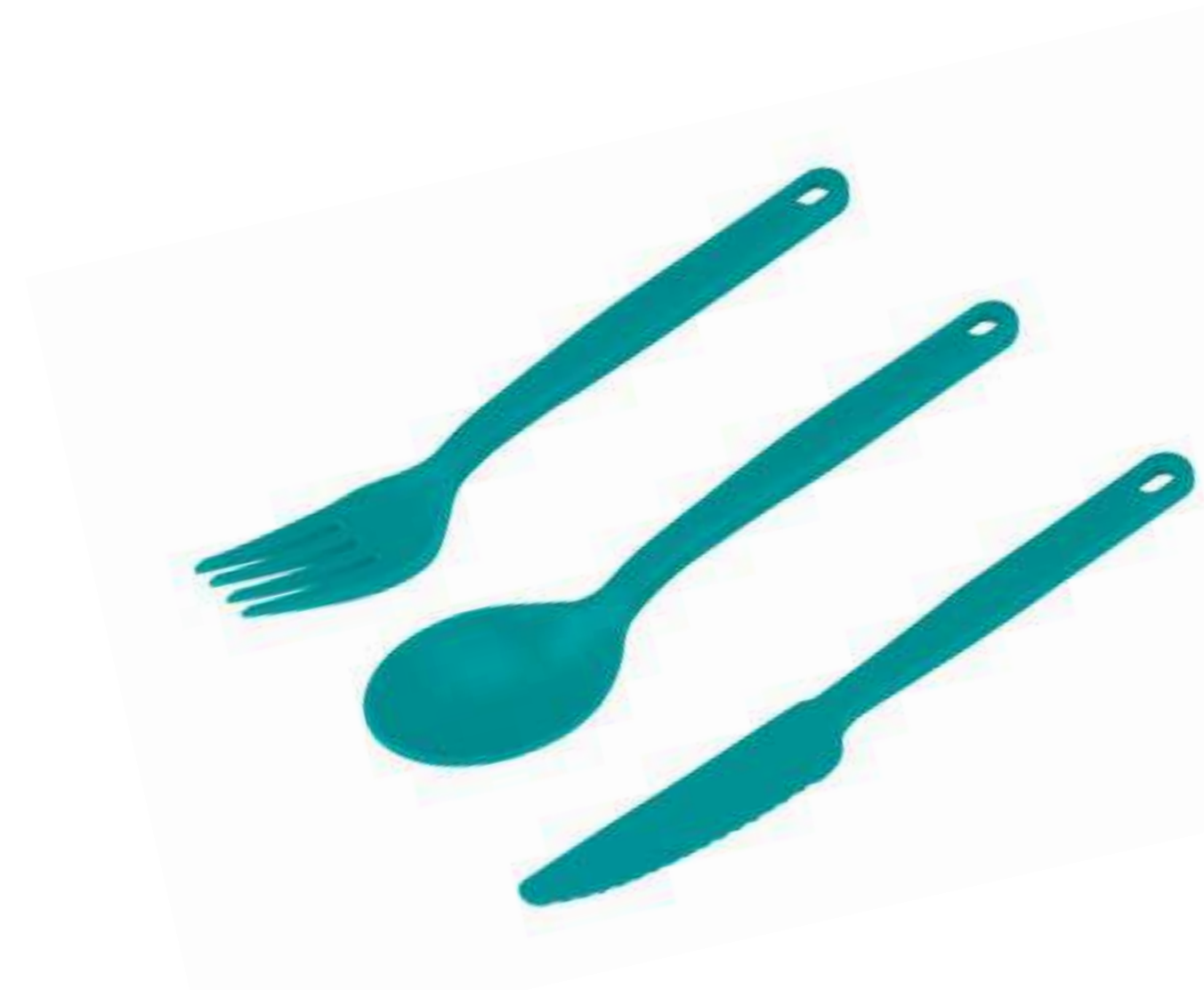

CAMP CUTLERY



TITANIUM CUTLERY



DELTA SERIES DINNERWARE



DELTALITE SERIES DINNERWARE



X-SERIES COLLAPSIBLE DINNERWARE



X-SEAL & GO COLLAPSIBLE CONTAINERS



ALPHALIGHT CUTLERY

Ultra-lightweight and durable, hard anodised aluminium cutlery.

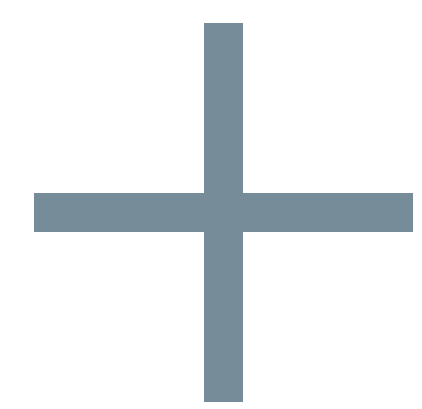

OUR ALPHALIGHT CUTLERY FEATURES:

TOUGH AND LIGHTWEIGHT

Hard-anodised aluminium utensils.

SMOOTH FINISH

Smooth matte finish for a comfortable feel.

HANDY

Comes with a mini carabiner to keep pieces together.

BPA FREE



ALPHALIGHT CUTLERY



ALPHA SET CUTLERY 3PC SET

Light and strong hard-anodised aluminium 3-pc cutlery set with built-in hex tools.





DELTA CUTLERY

Hard-wearing, functional and mouth-friendly camp cutlery.

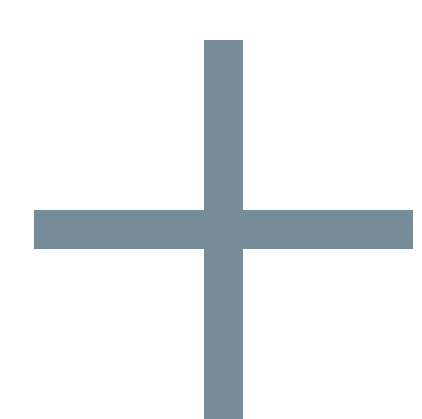

OUR DELTA CUTLERY FEATURES:

CLEVER AND PRACTICAL

Multi-functional ergonomic design, with knife, fork and spoon set designed to fit inside the Delta Bowl.

STRONG AND DURABLE

Food-grade glass-reinforced polypropylene.

EASY CLEAN

Odour and stain resistant.

DISHWASHER SAFE

BPA FREE



DELTA CUTLERY SET

FEATURES

- Included carabiner securely clips pieces together and doubles as a hang tool
- Sharp, part-serrated, part-flat knife

COLOURS



DELTA SPORK with Serrated Knife

FEATURES

- Serrated spreader knife integrated in handle

COLOURS



DELTA LONG HANDLED SPOON

FEATURES

- Longer reach for deeper containers
- Large capacity spoon—equal to 10ml/0.33floz (one dessert spoon)

COLOURS





CAMP CUTLERY

Lightweight, all purpose BPA-free Camp Cutlery.



OUR CAMP CUTLERY FEATURES:

LIGHT, STRONG AND DURABLE

Made from BPA-free polypropylene glass composite.

COMPACT PACKING

Shaped handles allow cutlery to neatly nest together for compact packing.

FULL-SIZED DESIGN

Easy to use bare handed or gloved.

EASY ORGANISATION

Small carabiner-compatible holes at each end.

DISHWASHER SAFE

BPA FREE



CAMP CUTLERY



CAMP CUTLERY SET

Includes fork, knife and spoon clipped together with a custom aluminium carabiner for organised packing.





TITANIUM CUTLERY

Exceptional strength to weight means your cutlery won't bend anymore than your back will carrying it.

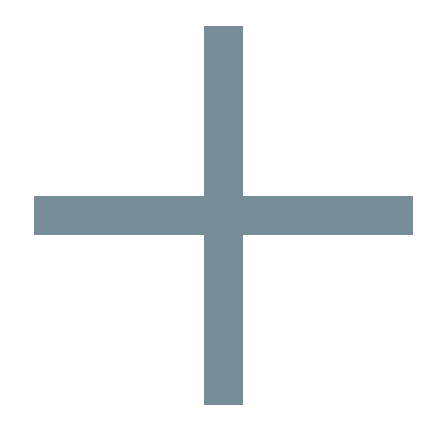

OUR TITANIUM CUTLERY FEATURES:

TOUGH AND LIGHTWEIGHT

Made from 100% titanium.

MOUTH FRIENDLY SHAPE

ANODISED FINISH

HANDY CARABINER

Comes with a mini carabiner to keep pieces together.

BPA FREE



TITANIUM SPORK



TITANIUM CUTLERY Set 3pc





ALPHALIGHT CUTLERY



PRODUCT NAME	CODE	SIZE	WEIGHT	COLOUR	RRP
AlphaLight Cutlery	ACUTALKN	Knife			
	ACUTALFK	Fork	11g 0.4 oz		
	ACUTALSPN	Spoon			
	ACUTALSPK	Spork	13g 0.5 oz	●	
	ACUTALSPKL	Long Spork	14g 0.5 oz		
	ACUTALSPNL	Long Spoon			
AlphaLight Cutlery Set	ACUTALSET2	2 Piece	21g 1 oz		
	ACUTALSET3	3 Piece	41g 1.2 oz		
AlphaSet Cutlery Set	ACUTASET3	3 Piece	42g 1.2 oz	●	

DELTA CUTLERY

PRODUCT NAME	CODE	SIZE	WEIGHT	COLOUR	RRP
Delta Cutlery Set	ADCUTSET	3 Piece	29g 1 oz		
Delta Spork with Serrated Knife	ADSPORK	Spork	12g 0.4 oz	● ● ●	
Delta Long Handled Spoon	ADLSPoon	Long Spoon			



CAMP CUTLERY

PRODUCT NAME	CODE	SIZE	WEIGHT	COLOUR	RRP
	ACUTKNIFE	Knife	9g 0.3 oz		
	ACUTFORK	Fork	10g 0.4 oz		
 Camp Cutlery	ACUTSPOON	Spoon	12g 0.4 oz	●	
	ACUTSPORK	Spork	10g 0.4 oz		
	ACUTTEA	Teaspoon	7g 0.2 oz		
 Camp Cutlery Set	ACUTL	3 Piece	31g 1.1 oz	●	

TITANIUM CUTLERY

PRODUCT NAME	CODE	SIZE	WEIGHT	RRP
Titanium Spork	ACUTTSPK	Spork	17g 0.6 oz	
 Titanium Cutlery Set	ACUTTSET3	3 Piece	40g 1.6 oz	



DELTA SERIES

Lightweight and durable with intuitive design details—there’s a solution for all your camp dining needs.

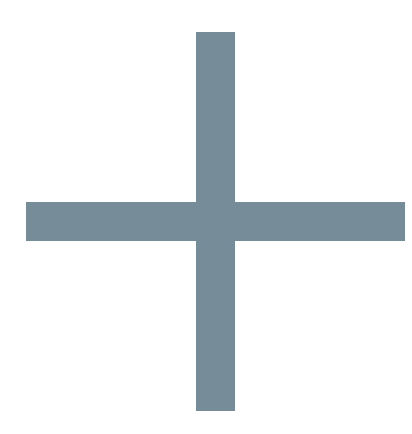

OUR DELTA RANGE FEATURES:

PROTEX BASE

Protex hex pattern base reduces weight and disperses surface temperature.

CLEVER DESIGN

Steep sides on our plates and bowls prevent food slopping over the sides, while the curvature of the base matches perfectly with the Delta Spoon and Spork.

THUMB GRIP

Keeps your fingers out of your food and doubles as a carabiner hang loop.

LIGHTWEIGHT

Lightweight, durable and easy-care.

FOOD-GRADE

BPA-free, glass reinforced polypropylene is microwaveable and dishwasher safe.

BPA FREE



Delta **PLATE**

Keep your food on your plate and your fingers burn-free—a cleverly designed camp plate with guard rails and heat-dispersing base.



COLOURS



Delta **BOWL +** Delta **BOWL WITH LID**

A lightweight, hard-wearing and functional camp bowl with deep sides and a heat-dispersing base for burn-free fingers.

BOWL WITH LID

- Lid keeps food inside and doubles as a chopping board or plate

COLOURS



Delta **MUG +** Delta **INSULMUG**

Not your ordinary camp mug—this one's designed to not burn your fingers. The ergonomic cool-grip rim eliminates the need for a hard-to-pack handle.

INSULMUG

- ThermoSkin insulation sleeve for a comfortable grip
- Sipping lid with secure seal and hang loop

COLOURS





DELTA CAMP SET



Delta **CAMP SET**

The Delta Camp Set combines all the lightweight and easy-to-clean essentials from our Delta range: a plate, bowl, mug and the 3-piece cutlery set. They come packaged in a handy gusseted mesh pouch allowing wet dishes to air dry and secures with an easy-to-use drawstring closure.

SUITS ONE PERSON

SET INCLUDES

Delta Plate, Delta Bowl, Delta Mug, Delta Cutlery Set

COLOURS





DELTALIGHT SERIES

Super-lightweight, easy-care and BPA-free dinnerware designed to nest.

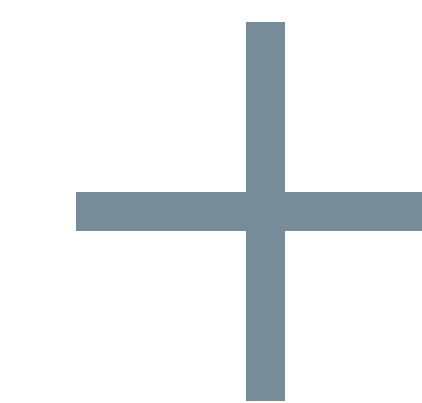

OUR DELTALIGHT RANGE FEATURES:

FOOD-GRADE

BPA-free, glass reinforced composite material is microwavable and dishwasher safe.

CLEVER DESIGN

Steep sides on our plates and bowls prevent food slopping over the sides, while the curvature of the base matches perfectly with the Delta Spoon and Spork.

ULTRALIGHT

Durable and easy-care.

COMPACT PACKABILITY

DeltaLight Mugs and Bowls combine with AlphaPots and SigmaPots to create compact cooking and dining systems.

BPA FREE



DeltaLight TUMBLER 2PK

Enjoy your favourite backcountry beverage in our space-saving, safe alternative to glassware.

FEATURES

- Unique, ovalised shape minimises space when multiple tumblers are stacked together
- Handy volumetric scale

COLOURS

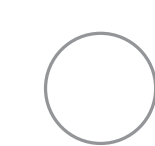

DeltaLight INSULMUG

With an easy-grip and generously-sized 350ml capacity, they come with removable silicone sipping lids and insulation sleeves.

FEATURES

- Fluted ribbed walls for increased insulation when used with the sleeve and a comfortable grip when used without

COLOURS





DELTALIGHT BOWL + CAMP SETS



NEW



DeltaLight BOWL SET

SMALL

SET INCLUDES

- 730ml bowl (charcoal)
- 800ml bowl (pacific blue)

Nests inside 1.9L Alpha and Sigma Pots or outside 1.2L pots

LARGE

SET INCLUDES

- 900ml bowl (charcoal)
- 1000ml bowl (pacific blue)

Nests inside 2.7L Alpha and Sigma pots or outside 1.2L pots



DeltaLight CAMP SET 2.2

SUITS TWO PEOPLE

SET INCLUDES

- 2 InsulMugs, 2 Bowls, 2 Delta Cutlery Sets & Storage Pouch

Nests inside 2.7L Alpha and Sigma Pots or outside 1.2L pots



DeltaLight SOLO SET

SUITS ONE PERSON

SET INCLUDES

- Mug, Bowl, Delta Cutlery Set & Storage Pouch

Nests inside 2.7L Alpha and Sigma Pots or outside 1.2L pots



DeltaLight CAMP SET 4.4

SUITS FOUR PEOPLE

SET INCLUDES





- 4 InsulMugs, 4 Bowls & Storage Pouch

Nests inside 2.7L Alpha and Sigma Pots or outside 1.2L pots











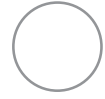

DELTA SERIES

PRODUCT NAME	CODE	DIMENSIONS	WEIGHT	MATERIALS	COLOUR	RRP
Delta Plate	ADPLATE	25 x 22.3 x 3cm 9.8 x 8.9 x 1 in	118g 4.2 oz			
Delta Bowl	ADBOWL	19 x 16 x 5cm 7.5 x 6.3 x 2 in	86g 3 oz			
 Delta Bowl With Lid	ADBOWLLID	19 x 16 x 6cm 7.5 x 6.3 x 2.4 in	149g 5.3 oz	Glass-reinforced polypropylene		
Delta Mug	ADMUG	ø8.9 x 10.8cm ø4.1 x 3.5 in	62g 2.2 oz			
Delta InsulMug	ADINMUG	ø10.5 x 9cm ø4.1 x 3.5 in	125g 4.4 oz			
 Delta Camp Set	ADSET	28 x 25.2 x 11cm 11 x 9.9 x 4.3 in	300g 10.6 oz			

DELTALIGHT SERIES

PRODUCT NAME	CODE	SIZE	PACKED DIMENSIONS	WEIGHT	MATERIALS	COLOUR	RRP
DeltaLight Tumbler 2pk	ADLTTUM2			104g 3.6 oz	Tritan co-polyester		
 DeltaLight InsulMug	ADLTINMUG		ø8.8 x 9.5cm ø3.3 x 3.8 in	78g 2.8 oz	Glass-reinforced polypropylene, neoprene sleeve		
 DeltaLight Bowl Set	AKI2008-05042102	Small	ø15.3 x 5.5 ø6 x 2.2 in	96g 3.4oz	Glass-reinforced polypropylene		
	AKI2008-05062101	Large	ø17.4 x 5.5 ø6.9 x 2.2 in	143g 5oz			
 DeltaLight Solo Set	ADLTSOLOSET	1 Person	ø19 x 9.5cm ø7.5 x 3.7 in	170g 7.1 oz			
DeltaLight Camp Set 2.2	ADLTSET2.2	2 Person		383g 14.7 oz	Glass-reinforced polypropylene, Nylon sleeve		
DeltaLight Camp Set 4.4	ADLTSET4	4 Person	ø19 x 11cm ø7.5 x 4.3 in	650g 24.3 oz			

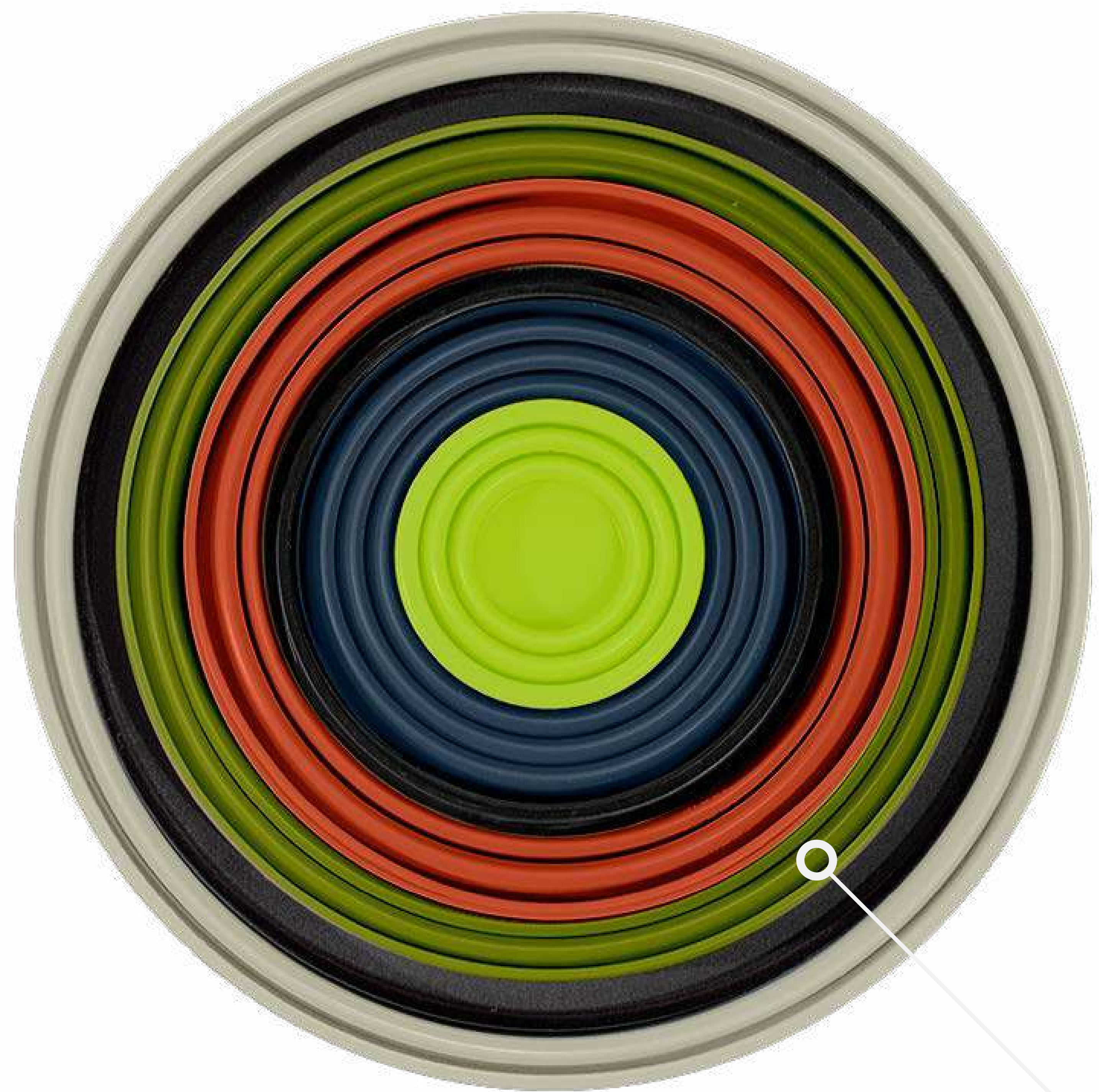

X-SERIES DINNERWARE

Made from flexible silicone, this collapsible dinnerware range packs away flat.

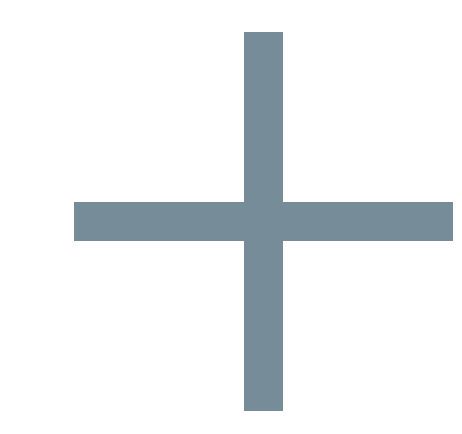

OUR X-SERIES DINNERWARE FEATURES:

FOOD GRADE

BPA-free, food grade flexible silicone sides.

SUPER COMPACT

Each piece collapses to a fraction of its in-use size.

EASE OF USE

Calibrated ridges act as a measuring cup.





X-SERIES DINNERWARE

X-BOWLS + X-PLATE

- Cut resistant, stable base is great for chopping and cutting food

X-CUP + X-MUG

- Nylon ring at the top maintains shape and prevents scalded fingertips

COLOURS



VIDEO



COOL GRIP X-TUMBLER & X-MUG

Keep your fingers cool and your drink securely in your grasp. The innovative Cool Grip construction uses specially designed fins to keep your fingers protected from the heat of your drink—and the rigid rim keeps it sturdy and easy to drink out of.

FEATURES

- Nests with other X-Series products

COLOURS





X-SETS



X-SET 2-PIECE

Collapsible nesting bowl and mug set for a solo camper.

TWO PIECE

SET INCLUDES
X-Mug, X-Bowl,
& Storage Pouch



X-SET 3-PIECE

Collapsible three-piece dinnerware set nests neatly in its own zippered pouch.

THREE PIECE

SET INCLUDES
X-Mug, X-Bowl,
X-Plate &
Storage Pouch





X-SEAL & GO

Perfect for culinary adventures on the trail—or at the office.



OUR X-SEAL & GO RANGE FEATURES:

QUICK CLOSE LIDS

Leakproof, sealable lid locks into place with a simple quarter turn.

ERGONOMIC DESIGN

Cleverly designed lids and base have ergonomic grips for easy twisting.

EASY CLEAN THREAD

Three individual threads make cleaning much easier.

TINY PACK SIZE

Our 600ml X-Seal & Go collapses to 19mm tall to save space in your bag.

VOLUMETRIC MEASUREMENTS

Printed on the inside of each container.

CONVENIENT

Microwave and dishwasher safe.



Small and Medium sizes fit inside Large and XLarge lids to create handy lunch kits

X-SEAL & GO



SMALL



MEDIUM



LARGE



XLARGE

X-SEAL & GO SETS



SET SMALL
1 Large / 1 Small



SET LARGE
1 XL / 1 Medium





X-SERIES

PRODUCT NAME	CODE	DIMENSIONS	COLLAPSES TO	WEIGHT	MATERIALS	COLOUR	RRP
X-Shot	AXSHOT	ø6.5 x 6cm ø2.6 x 2.4 in	1.2cm 0.5 in	24g 0.8 oz	Food grade flexible silicone		
X-Cup	AXCUP	ø9.5 x 9.5cm ø3.7 x 2.4 in		45g 1.6 oz			
X-Mug	AXMUG	ø11 x 8cm ø3.7 x 3.2 in		60g 2.1 oz			
X-Bowl	AXBOWL	ø15 x 6cm ø5.9 x 2.4 in	1.5cm 0.6 in	80g 2.8 oz	Food grade flexible silicone, Nylon 66		
XL-Bowl	AXLBOWL	ø15 x 5.5cm ø5.9 x 2.2 in		110g 3.9 oz			
X-Plate	AXPLATE	ø20 x 3.5cm ø7.9 x 1.4 in		164g 5.8 oz			
X-Mug Cool Grip	AXCGMUG	ø11 x 8cm ø3.7 x 3.2 in	1.5cm 0.6 in	72g 2.5 oz	Food grade flexible silicone, Nylon 66		
X-Tumbler Cool Grip	AXCGTUM	ø10.3 x 7.5cm ø4.1 x 3 in		68g 2.4 oz			

X-SETS

PRODUCT NAME	CODE	COLLAPSES TO	WEIGHT	MATERIALS	COLOUR	RRP
X-Set: 2-Pce	AXSET2	1.5cm 0.6 in	180g 7 oz	Food grade flexible silicone, Nylon 66		
X-Set: 3-Pce	AXSET3		364g 12.8 oz			

X-SEAL & GO

PRODUCT NAME	CODE	SIZE	DIMENSIONS	COLLAPSES TO	WEIGHT	MATERIALS	COLOUR	RRP
X-Seal & Go	AXSEALS	Small	ø9 x 7cm ø3.5 x 2.8 in	2cm 0.8 in	60g 2.1 oz	Food grade flexible silicone, Nylon 66 base, polypropylene lid		
	AXSEALM	Medium	ø11.4 x 8.5cm ø4.5 x 3.4 in		90g 3.2 oz			
	AXSEALL	Large	ø15.5 x 5cm ø6.1 x 2 in	3cm 1.2 in	145g 5.1 oz			
	AXSEALXL	XL	ø18.5 x 6cm ø7.3 x 2.4 in		195g 6.9 oz			
X-Seal & Go Set	AXSEALSETS	Small		3.5cm 1.4 in	205g 7.2 oz			
	AXSEALSETL	Large			285g 10 oz			



COOKWARE

Modular systems designed for ergonomic and efficient cooking when in use—and space-saving when packed away.





EXPLORE THE RANGE

COOKING TOOLS + UTENSILS



CAMP KITCHEN FOLDING SERVING SPOON + SPATULA



CAMP KITCHEN TOOL KIT

COOKWARE + COOKWARE SETS



SIGMA SERIES



ALPHA SERIES



X-POT



SIGMA SETS



ALPHA SETS



X-SETS



FOLDING COOKING UTENSILS

Designed with the camp cook in mind, an ergonomic handle and strong, lightweight materials all add to the cooking experience.

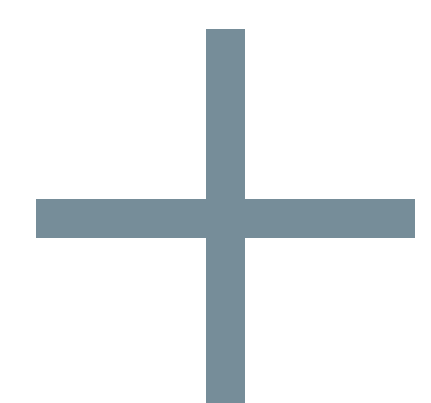

OUR FOLDING COOKING UTENSILS FEATURE:

STRONG AND LIGHTWEIGHT

Made with glass reinforced Nylon and food grade silicone.

LIGHTWEIGHT

Perfect for fast-and-light backpacking trips.

FLEX AND STRENGTH

Glass reinforced Nylon gives enough flex to flip pancakes and enough rigidity to scrape off burnt rice.

ERGONOMIC DESIGN

Sturdy and easy to hold with a shape that's designed to scrape clean the sides of our cookware.

PACKS UP SMALL

Simply fold the handle when the camp cooking is done—easily stows inside the 1.2L Alpha and Sigma Pots.

BPA FREE



NEW

CAMP KITCHEN FOLDING SPATULA

This ultralight folding spatula flips pancakes as easily as it packs away.



NEW

CAMP KITCHEN FOLDING SERVING SPOON

Prepare and cook delicious meals in the backcountry with this ultralight folding serving spoon.

FEATURES

- 100ml volume and volumetric measurements for measuring ingredients





NEW

CAMP KITCHEN TOOL KIT

This 10-piece cooking and wash kit is made for your backcountry camp kitchen.

10 PIECE KIT



INCLUDES

- Folding Spatula
- Folding Serving Spoon
- Pot Scrubber
- 50ml Wilderness Wash
- 2x 50ml + 1x 100ml Reusable Spice/Oil Bottles
- Double Sided Washcloth
- DryLite Dish Towel
- Hangable Nylon Storage Roll





COOKING TOOLS + UTENSILS

PRODUCT NAME	CODE	DIMENSIONS	PACKED DIMENSIONS	WEIGHT	MATERIALS	RRP
 Camp Kitchen Folding Spatula	NEW ACK022021-040101	23.5 x 7.5 x 2cm 9.3 x 3 x 0.8in	12 x 7.5 x 2cm 4.7 x 3 x 0.8in	57g 2oz	Glass-reinforced Nylon	
 Camp Kitchen Folding Serving Spoon	NEW ACK022031-040102	23 x 6.5 x 4.5cm 9.1 x 2.6 x 1.8in	12 x 6.5 x 2cm 4.7 x 2.6 x 0.8in	66g 2.3oz	Glass-reinforced Nylon, Silicone	
 Camp Kitchen Tool Kit 10pc	NEW ACK022011-122104		12 x 23.5 x 6cm 4.7 x 9.3 x 2.4in	310g 10.9oz	Spatula: Glass-reinforced Nylon, Serving Spoon: Glass-reinforced Nylon; Silicone; Scrubber: Polypropylene + Nylon bristles; Wilderness Wash; Spice Bottles: HDPE; Towels: 80% Polyester-20% Nylon, Pouch: Nylon	



SIGMA SERIES

For those backcountry chefs whose appetites were whetted by the high-tech design of the Alpha cookware, but who love the simple durability of stainless steel.

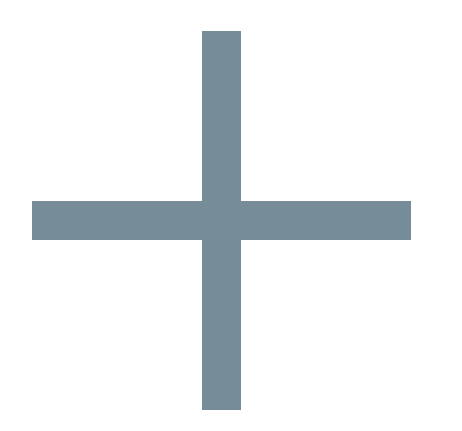

OUR SIGMA SERIES POTS FEATURE:

FULLY FEATURED LID

Easy flow strainer lid for efficient draining with integrated patent-pending LID KEEP to perch the lid out of dirt's reach.

STRONG AND DURABLE

Premium grade stainless steel cooking surface.

SECURE AND STABLE

Anti-slip base coating provides stability on camp stoves.

PIVOT-LOCK

PIVOT-LOCK handle with ergonomic silicone grip for secure, easy operation.

SMART COOKING

Graded volumetric scale for accurate measurement.

EASY CLEAN

Large internal radius allows easy cleaning and matches the Delta cutlery profile.

NESTING DESIGN

SigmaPots are compatible with DeltaLight dinnerware, AlphaPots and AlphaPans.

FOOD SAFE SETS

Delta-Light dinnerware used in our Sigma Sets is microwave and dishwasher safe, and made from BPA-free, food-grade materials.



PRECAUCIÓN

- Asegúrese de que el mango es bien asegurado con el cierre de seguridad antes de usar la cazuela.
- Para uso sólo con hornillos de camping, convencionales u hogueras.
- No caliente la cazuela vacía.
- No exponga el mango de silicona a la llama directa. Limite las llamas del fuego a la base de la cazuela. Las llamas laterales pueden dañar el mango de silicona.
- El contenido de la cazuela puede estar extremadamente caliente; tenga cuidado al usarla.
- Compruebe siempre la temperatura del mango de silicona antes de agarrarlo. El mango de silicona puede alcanzar temperaturas superiores a 250°C sin mostrar señales de daño.
- No apta para lavavajillas.

WARNUNGSWEISE

- Vor der Nutzung des Kochgeschirrs muss sichergestellt sein, dass die Griffverriegelung mit dem Verschlussmechanismus sicher geschlossen ist.
- Die Töpfe sind nur für den Einsatz auf Campingkochern, herkömmlichen Kochherden oder Feuerstellen geeignet.
- Die Töpfe dürfen nicht leer erhitzt werden.
- Die Silikon-Griffe sind nicht für den direkten Kontakt mit der Flamme geeignet. Begrenzen Sie die Flammen auf die Basis des Kochgeschirrs. Seitliche Flammen können den Silikon-Griff beschädigen.
- Die Töpfe dürfen nicht mit offener Flamme befüllt werden.
- Der Inhalt des Kochgeschirrs kann sehr heiß sein. Achten Sie beim Umgang mit dem Kochgeschirr auf die Temperatur des Silikon-Griffs. Der Griff kann Temperaturen über 250°C erreichen, ohne Anzeichen von Beschädigung zu zeigen.
- Die Sigma-Griffe können nicht in die Spülmaschine gegeben werden.
- Der Topf ist nicht spülmaschinengeeignet.

SEATOSUMMIT

SIGMA POT 3.7L | 125 fl oz

Premium Stainless Steel Compact Cooking System



PREMIUM GRADE STAINLESS STEEL

BPA FREE





SIGMAPOT

Our premium grade stainless steel SigmaPots provide long-lasting performance for your outdoor kitchen.

SIZES 1.2L / 1.9L / 2.7L / 3.7L





SIGMASETS



SIGMASET 2.0

SUITS TWO+ PEOPLE

SET INCLUDES

- 1x SigmaPot 1.2L
- 1x SigmaPot 2.7L
- 1x Dishcloth



SIGMASET 2.1

SUITS TWO PEOPLE

SET INCLUDES

- 1x SigmaPot 1.9L
- 2x DeltaLight InsulMugs
- 2x DeltaLight Bowls



SIGMASET 1.1

SUITS ONE PERSON

SET INCLUDES

- 1x SigmaPot 1.2L
- 1x DeltaLight InsulMug
- 1x DeltaLight Bowl



SIGMASET 2.2

SUITS TWO PEOPLE

SET INCLUDES

- 1x SigmaPot 1.2L
- 1x SigmaPot 2.7L
- 2x DeltaLight InsulMugs
- 2x DeltaLight Bowls
- 1x Dishcloth





SIGMA POTS

PRODUCT NAME	CODE	SIZE	DIMENSIONS	WEIGHT	MATERIALS	RRP
 Sigma Pot	AKI3009-02381801	1.2L	26.9 x 14.2 x 9.6cm 10.6 x 5.6 x 3.8 in	250g 8.8 oz	Marine-grade stainless steel pot, stainless steel silicone grip handle, aluminium lid	
	AKI3009-02391803	1.9L	29 x 16.3 x 11.5cm 11.4 x 6.4 x 4.5 in	317g 11.2 oz		
	AKI3009-02401805	2.7L	32.6 x 18.1 x 12.1cm 12.8 x 7.1 x 4.8 in	382g 13.5 oz		
	AKI3009-02411807	3.7L	34.6 x 20.2 x 13.6cm 13.6 x 8 x 5.4 in	481g 17 oz		

SIGMASETS

PRODUCT NAME	CODE	SIZE	DIMENSIONS	WEIGHT	MATERIALS	RRP
SigmaSet 2.0	AKI5009-03121808	1.2L+2.7L	32.6 x 18.1 x 12.1cm 12.8 x 7.1 x 4.8 in	656g 22.3 oz	Marine-grade stainless steel pot, stainless steel silicone grip handle, aluminium lid	
SigmaSet 1.1	AKI5009-03122103	1.2L	26.9 x 14.2 x 9.6cm 10.6 x 5.6 x 3.8 in	295g 13.9 oz	 Marine-grade stainless steel pot, stainless steel silicone grip handle, aluminium lid, glass reinforced polypropylene, neoprene mug sleeve	
SigmaSet 2.1	AKI5009-03122106	1.9L	29 x 16.3 x 11.5cm 11.4 x 6.4 x 4.5 in	552g 21.5 oz		
SigmaSet 2.2	AKI5009-03122101	1.2L+2.7L	32.6 x 18.1 x 12.1cm 12.8 x 7.1 x 4.8 in	1284g 33.1 oz		



ALPHA SERIES

Bringing performance and style to outdoor cookware, this versatile range of lightweight nesting pots and pans caters to a wide variety of users from extreme expeditioners and outdoor adventurers to family campers.



OUR ALPHA SERIES POTS FEATURE:

FULLY FEATURED LID

Easy flow strainer lid for efficient draining with integrated patent-pending LID KEEP to perch the lid out of dirt's reach.

LIGHT AND SPACE-SAVING

A two pot, two-person cook set weighs just 765g and nests to ø19 x 13cm.

PIVOT-LOCK

PIVOT-LOCK handle with ergonomic silicone grip for secure, easy operation.

SMART COOKING

Graded volumetric scale for accurate measurement.

EASY CLEAN

Large internal radius allows easy cleaning and matches the Delta cutlery profile.

NESTING DESIGN

AlphaPots are compatible with DeltaLight dinnerware, SigmaPots and AlphaPans.

FOOD SAFE SETS

DeltaLight dinnerware used in our Alpha Sets is microwave and dishwasher safe, and made from BPA-free, food-grade materials.



BPA FREE



HARD ANODISED ALUMINIUM



ALPHA POT

High quality aluminium and anodising keep weight down, while the nesting design and locking handle keeps your gear neat and organised.

SIZES 1.2L / 1.9L / 2.7L / 3.7L

VIDEO



ALPHA PAN

Flaunt your culinary flair and saute, scramble or stir-fry in the backcountry with our AlphaPans. The advanced PFOA-free coating provides non-stick performance with a durable and abrasion resistant finish.

FEATURES

- Ergonomic flip-up handle with safety lock folds underneath the pan when not in use for compact stacking and storage
- 8in AlphaPan fits perfectly around the base of the 2.7L Alpha or Sigma Pots

SIZES 8in / 10in





ALPHASETS



VIDEO



ALPHASET 2.0

SUITS TWO+ PEOPLE

SET INCLUDES

- 1x AlphaPot 1.2L
- 1x AlphaPot 2.7L
- 1x Dishcloth



ALPHASET 2.1

SUITS TWO PEOPLE

SET INCLUDES

- 1x AlphaPot 1.9L
- 2x DeltaLight InsulMugs
- 2x DeltaLight Bowls



ALPHASET 2.2

SUITS TWO PEOPLE

SET INCLUDES

- 1x AlphaPot 1.2L
- 1x AlphaPot 2.7L
- 2x DeltaLight InsulMugs
- 2x DeltaLight Bowls
- 1x Dishcloth



ALPHASET 1.1

SUITS ONE PERSON

SET INCLUDES

- 1x AlphaPot 1.2L
- 1x DeltaLight InsulMug
- 1x DeltaLight Bowl



ALPHASET 4.2

SUITS FOUR PEOPLE

SET INCLUDES

- 1x AlphaPot 2.7L
- 1x AlphaPot 3.7L
- 4x DeltaLight InsulMugs
- 4x DeltaLight Bowls
- 1x Dishcloth





ALPHAPOTS & PANS

PRODUCT NAME	CODE	SIZE	COLLAPSED DIMENSIONS	WEIGHT	MATERIALS	RRP
AlphaPot	AKI3004-02380501	1.2L	ø16 x 10cm ø6.3 x 3.94 in	187g 6.6 oz	hard-anodised aluminium alloy, stainless steel silicone grip handle, aluminium lid	
	AKI3004-02390502	1.9L	ø17 x 12cm ø6.69 x 4.72 in	230g 8.1 oz		
	AKI3004-02400503	2.7L	ø19 x 13cm ø7.48 x 5.12 in	282g 9.9 oz		
	AKI3004-02410504	3.7L	ø21 x 15cm ø8.27 x 5.91 in	337g 11.9 oz		
AlphaPan	APOTAPAN8	8in	ø26 x 5cm ø7.87 x 1.97 in	245g 8.6 oz	hard-anodised aluminium alloy, stainless steel silicone grip handle	
	APOTAPAN10	10in	ø20 x 5cm ø10.24 x 1.97 in	335g 11.8 oz		

ALPHA SETS

PRODUCT NAME	CODE	COLLAPSED DIMENSIONS	WEIGHT	MATERIALS	RRP
AlphaSet 2.0	AKI5004-03122102	ø19 x 13cm ø7.48 x 5.12 in	459g 16.2 oz	hard-anodised aluminium alloy, stainless steel silicone grip handle, aluminium lid	
AlphaSet 1.1	AKI5004-03122101	ø16 x 10cm ø6.3 x 3.94 in	330g 14.1 oz		
AlphaSet 2.1	AKI5004-03122103	ø17 x 12cm ø6.69 x 4.72 in	521g 18 oz	hard-anodised aluminium alloy, stainless steel handle, aluminium lid, glass-reinforced polypropylene dinnerware, neoprene mug sleeve	
AlphaSet 2.2	AKI5004-03122104	ø19 x 13cm ø7.48 x 5.12 in	765g 30.5 oz		
AlphaSet 4.2	AKI5004-03122105	ø21 x 15cm ø8.27 x 5.91 in	1221g 48.3 oz		



X-POT

Collapsible pots for quick and easy backcountry cooking. The Backpacker magazine Editor's Choice award was bestowed upon the X-Pot in 2015 for its innovation, space-saving capability and functionality. The real beauty of X-Series cookware is its ability to nest neatly with other pieces from the range and collapse to a small disc that can easily slide into a backpack, canoe bag or camping box.



OUR X-POTS FEATURE:

SUPER COMPACT

Each piece collapses to a fraction of its in-use size.

GREATER CONTROL

Translucent, durable plastic lid shortens boil time and allows finer temperature control.

NESTING DESIGN

X-Series products collapse and nest inside each other to form compact cooking and dining sets.

LIGHTWEIGHT AND DURABLE

Hard-anodised aluminium base provides uniform heat distribution.

SMART COOKING

Measurements imprinted on the inside.

EASY TRANSPORT

Silicone handles secure the lid to the pot for transport.

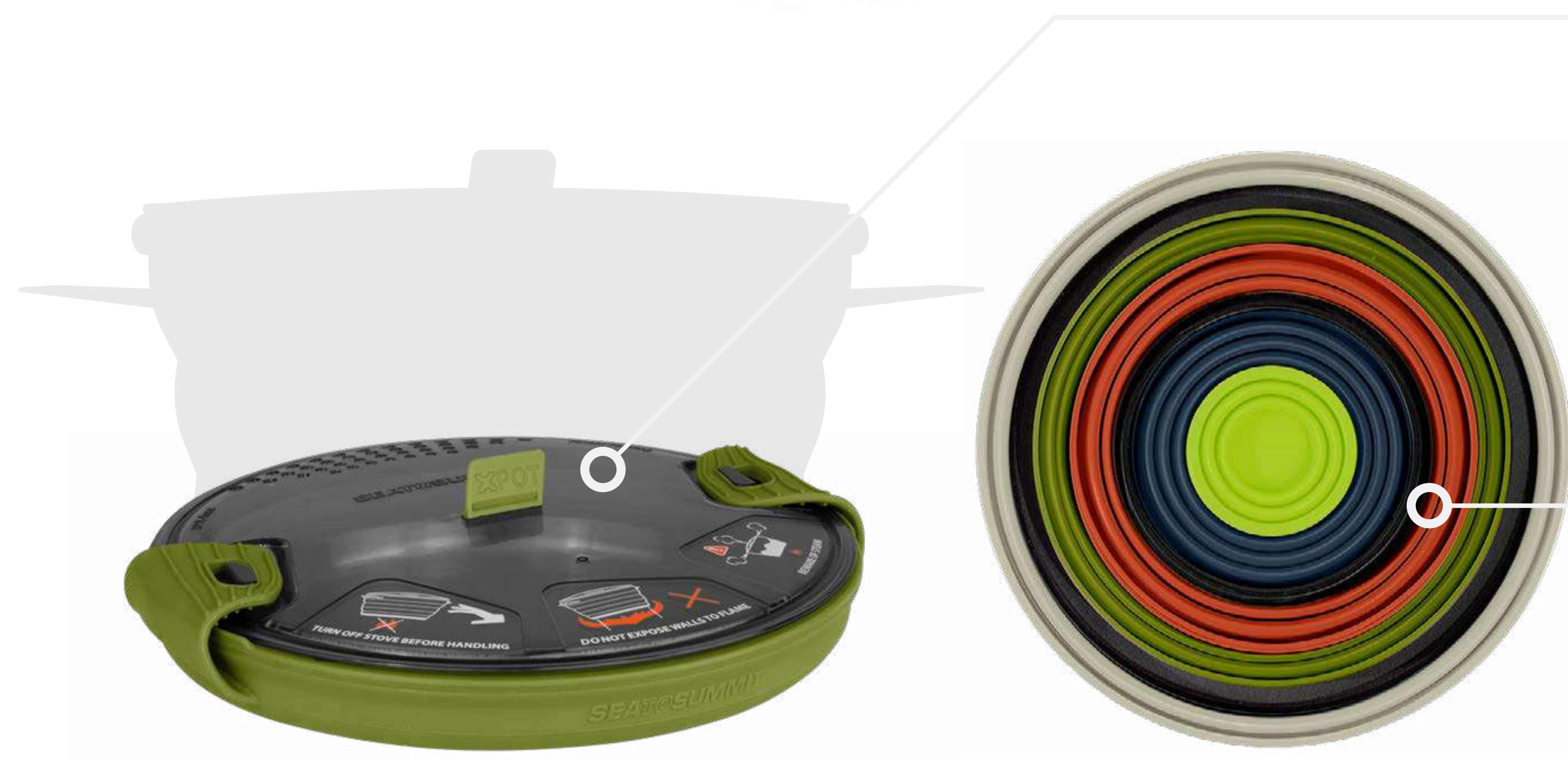

BPA FREE

HARD ANODISED ALUMINIUM

FOOD GRADE HEAT RESISTANT SILICONE





X-POT

Our X-Pots are the perfect solution for consumers who are light on storage space but who still want to cook real food in the backcountry.

SIZES 1.4L / 2.8L / 4.0L

COLOURS



X-PAN 8 INCH

This 8-inch pan offers a low profile, space-saving design that fits neatly together with the 2.8L X-Pot in a nesting pot/pan system.

FEATURES

- Stiff and non-corrosive stainless steel handles fold up for use and down for transport

COLOURS





X-POT KETTLE

Is it a pot or is it a kettle? It's both—and now available in two sizes. The perfect all-in-one flat-pack solution for fast and light adventures.

FEATURES

- A silicone strap secures the lid and handles during transport

SIZES 1.3L / 2.0L

COLOURS



VIDEO



X-BREW COFFEE DRIPPER

For the environmentally minded backcountry barista: a collapsible coffee dripper with super-fine stainless steel filter—no need for single-use paper filters!

FEATURES

- Makes up to two cups—just add coffee grounds and hot water

COLOURS



VIDEO





X-SETS



X-SET 11

SUITS TWO PEOPLE

SET INCLUDES
2x X-Mugs
X-Pot Kettle 1.3L



X-SET 31

SUITS TWO PEOPLE

SET INCLUDES
2x X-Mugs
2x X-Bowls
X-Pot 2.8L



X-SET 12

SUITS TWO PEOPLE

SET INCLUDES
2x X-Mugs
2x X-Bowls
X-Pot Kettle 2.0L



X-SET 32

SUITS TWO+ PEOPLE

SET INCLUDES
X-Pot Kettle 1.3L
X-Pan 8 Inch
X-Pot 2.8L



X-SET 21

SUITS ONE PERSON

SET INCLUDES
1x X-Mug
1x X-Bowl
X-Pot 1.4L



X-SET 33

SUITS TWO+ PEOPLE

SET INCLUDES
X-Pot Kettle 1.3L
X-Pot 2.8L





X-SERIES COOKWARE

PRODUCT NAME	CODE	SIZE	DIMENSIONS	COLLAPSED DIMENSIONS	WEIGHT	MATERIALS	COLOUR	RRP
X-Pot	AXPOT1.4	1.4L	ø19 x 6.4cm ø7.5 x 2.5 in	4cm 1.6 in	250g 10.4 oz	Hard-anodised aluminium base, food-grade silicone side walls, Tritan strainer lid		
	AXPOT2.8	2.8L	ø21.3 x 11.5cm ø8.4 x 4.5 in		365g 12.9 oz			
	AXPOT4.0	4.0L	ø25.4 x 9.8cm ø10 x 3.9 in	4.5cm 1.8 in	562g 21.6 oz			
X-Pan 8 Inch	AXPAN8INCH		ø18 x 4cm ø7.1 x 1.5 in		230g 8.1 oz	Hard-anodised aluminium, silicone handles		
X-Pot Kettle	AXKET1.3	1.3L	ø15.3 x 9cm ø6 x 3.5 in	3.5cm 1.4 in	186g 6.6 oz	Hard-anodised aluminium base, food-grade silicone side walls, Tritan strainer lid		
	AXKET2.2	2.0L	ø19.5 x 11cm ø7.7 x 4.5 in	4.5cm 1.6 in	290g 10.2 oz			
X-Brew Coffee Dripper	AXBREW		ø11 x 9cm ø4.3 x 3.5 in	2cm 0.8 in	85g 4 oz	Food-grade silicone, stainless steel mesh		

X-SETS

PRODUCT NAME	CODE	COLLAPSED DIMENSIONS	WEIGHT	MATERIALS	COLOUR	RRP
X-Set 11	AXSET11	4cm 1.6 in	316g 12 oz	Hard-anodised aluminium, food-grade silicone side walls, Tritan lid, Nylon 66 rims / kettle handles		
X-Set 12	AXSET12	4.5cm 1.8 in	584g 20.6 oz			
X-Set 21	AXSET21		394g 15.2 oz			
X-Set 31	AXSET31		607g 24 oz			
X-Set 32	AXSET32	5cm 2 in	779g 28 oz			
X-Set 33	AXSET33		551g 20 oz			



WATER TRANSPORT

Our home in Western Australia is one of the driest places in the world—when we plan our adventures, water transport is top of our list. Designed to work well in the harshest environments, our water transport solutions are lightweight, collapsible, easy to operate and reliable.



BPA FREE

PVC free



EXPLORE THE RANGE

WATERCELLS



WATERCELL X



WATERCELL ST

PACK TAPS



PACK TAP



Multi-function cap



Shower attachment



Fill handle



Adjustable webbing strap system



WATERCELL X

Ditch the awkward jerry-can or plastic water container and embrace the Watercell X, your durable soft-sided water storage solution for any adventure. We've provided multiple lash, carry and hang options, a cap that lets you fine-tune flow-control and a baffled design that makes for easy packing when full. The wide-mouth opening is easy to fill and uses a standard thread to make it compatible with most common water filtration systems. And when not in use it folds away to a minimal size that barely takes up any room in your pack, kayak or vehicle.

FEATURES

- Strong RF-welded 3D shape with internal baffle for ease of use and compact packing

SIZES 4L / 6L / 10L / 20L





WATERCELL ST

Minimalist, strong and pliable, your streamlined water storage solution for lightweight adventures.

FEATURES

- Strong RF-welded 3D shape with internal baffle for ease of use and compact packing
- Screw-top standard wide-mouth opening

SIZES 4L / 6L / 10L



PACK TAP

Bulk water on tap—ideal for groups, sea kayaking or whenever you have to carry a lot of water.

FEATURES

- Double layer, tough Mylar bladder
- Easy one-handed valve operation
- Bladder can be easily and cheaply replaced to maximise life span of product

SIZES 4L / 6L / 10L

COLOURS ● ● ●

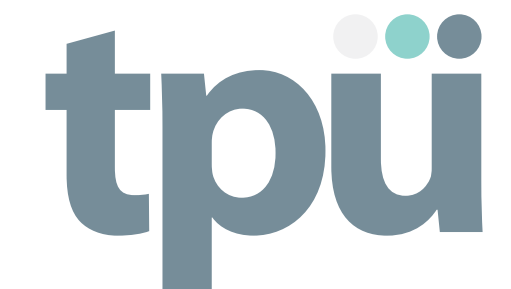



WATERCELLS

PRODUCT NAME	CODE	SIZE	DIMENSIONS	WEIGHT	MATERIALS	COLOUR	RRP
Watercell X	AWATCELX4	4L	28 x 21.5 x 10cm 11 x 8.5 x 4 in	172g 6.6 oz	400D Nylon, TPU lining and cap		
	AWATCELX6	6L	35 x 23 x 10.5cm 13.8 x 9 x 4.3 in	196g 7.5 oz			
	AWATCELX10	10L	42 x 28.5 x 12.5cm 16.5 x 11.3 x 5 in	245g 9.5 oz			
	AWATCELX20	20L	51.5 x 37.5 x 16cm 20.3 x 14.8 x 6.3 in	336g 13.5 oz			
Watercell ST	AWATCELST4	4L	28 x 21.5 x 10cm 11 x 8.5 x 4 in	126g 5 oz	TPU		
	AWATCELST6	6L	35 x 23 x 10.5cm 13.8 x 9 x 4.3 in	148g 5.9 oz			
	AWATCELST10	10L	42 x 28.5 x 12.5cm 16.5 x 11.3 x 5 in	188g 7.5 oz			

PACK TAPS

PRODUCT NAME	CODE	SIZE	DIMENSIONS	WEIGHT	MATERIALS	COLOUR	RRP
Pack Tap	APT4LT	4L	34 x 32cm 14.6 x 14.6 in	114g 4 oz	300D polyester exterior, Mylar bladder		
	APT6LT	6L	36 x 38cm 17.5 x 17.5 in	124g 4.4 oz			
	APT10LT	10L	41 x 43cm 20.1 x 20.1 in	192g 6.8 oz			
Pack Tap Replacement Bladder	ABLA	4/6L			Mylar		
	ABLA10	10L					

STORAGE



DRY STORAGE

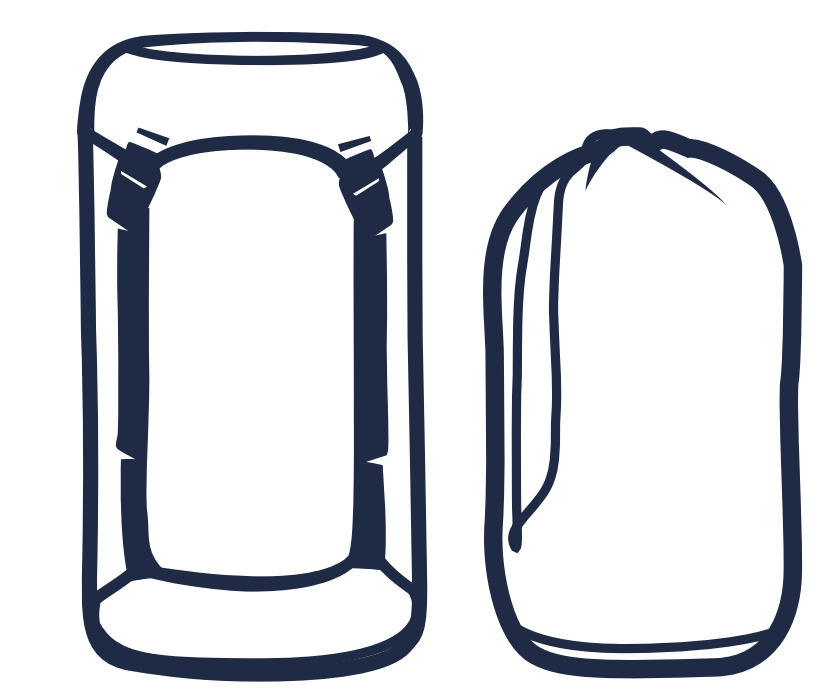

**STUFF +
COMPRESSION SACKS**



DRY STORAGE

For over 30 years we've been innovating with both design and materials to make the best possible product to protect gear from the elements. We created the concept of lightweight dry sacks back in the early 90s and our designs have received more industry awards than any other brand in this category.

We meticulously choose fabrics and components to ensure that the weight-performance ratio is best for the intended use. From ultralight storage and organisation inside your pack to heavy duty bags designed for high abrasion environments, our extensive range has a solution for any scenario.



SECURE CLOSURE

Our dry bags offer category-leading performance you can trust. The buckles attach closer to the fabric and won't unroll under tension. The non-wicking closure strip prevents water seeping inside when it's closed. The differential cut and stiffening strip make it easier to create an effective fold. It's this level of hidden detail that differentiates our award-winning products.

DURABLE SEAMS

Seams are one of the potential failure points of any dry bag. We either double stitch our seams or use RF-welding so our bags are more durable and abrasion-resistant—they're built to last.

FIELD REPAIRABLE

All our dry bags feature our patented Field Repair Buckles for fast and easy repairs in the field.



EXPLORE THE RANGE

ULTRALIGHT



Ultra-Sil NANO DRY SACK

15D ULTRA-SIL™



Ultra-Sil COMPRESSION DRY SACK

30D ULTRA-SIL™



Ultra-Sil DRY SACK

LIGHTWEIGHT



NYLON COMPRESSION DRY SACK



LIGHTWEIGHT DRY SACK

70D WATERPROOF FABRIC



SLING DRY BAG



EVAC DRY SACK

LIGHTWEIGHT



FIRST AID DRY SACK



VIEW DRY SACK

70D WATERPROOF FABRIC



STOPPER DRY BAG

210D STOPPER FABRIC



CLEAR STOPPER DRY BAG

HEAVY DUTY



BIG RIVER DRY BAG

420D WATERPROOF FABRIC



HYDRAULIC DRY BAG

600D HYDRAULIC FABRIC



HYDRAULIC DRY PACK



COMPRESSION DRY BAGS

Air compresses out, water can't get in—keep your bulky soft gear dry and compressed for compact packing.



OUR COMPRESSION DRY BAGS FEATURE:

FOUR STRAPS
for even compression.

WHITE INTERIOR
for better visibility of contents.

EVENT® FABRIC BASE
Waterproof and air permeable base allows air to be pushed out but water can't get in—completely valve-free.

PULL HANDLE
on the bottom.





ULTRALIGHT

30D ULTRA-SIL™



Ultra-Sil EVENT® DRY COMPRESSION SACK

All the benefits but roughly half the weight of the original 70D Dry Compression Sack.

FEATURES

- High Tenacity CORDURA® yarn creates a fabric that is stronger and more durable
- The Slippery finish of the siliconised fabric makes it easier to pack and unpack

WATERHEAD 2,000mm

SIZES XXS / XS / S / M / L

COLOURS



LIGHTWEIGHT

70D WATERPROOF FABRIC



EVENT® DRY COMPRESSION SACK

It earned a Backpacker Editors' Choice Award in 2007 and it's still a winner today.

FEATURES

- Valve-free and waterproof compression for your soft and bulky items

WATERHEAD 10,000mm

SIZES XS / S / M / L / XL

COLOURS





DRY BAGS

Our dry storage options span from the Ultra-Sil Nano Dry Sacks to the super burly 600D Hydraulics, you'll find the right choice for any activity.

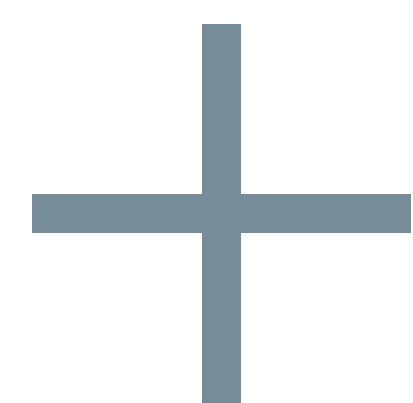

OUR DRY BAGS FEATURE:

WATERTIGHT

Non-wicking closure strip ensures moisture is not drawn into the bag when rolled shut.

FIELD REPAIR BUCKLE

Replaceable Field Repair Buckles provide an easy mending solution.

WHITE INTERIOR

For greater visibility of contents.

TRUSTED SEAL

Fully seam-sealed for water resistance.





ULTRALIGHT | 15D ULTRA-SIL™



Ultra-Sil NANO DRY SACK

When every gram counts, these deliver for ultra-lightweight pack organisation.

FEATURES

- 30% lighter than our award-winning Ultra-Sil Dry Sack
- Slippery siliconised fabric for easy packing

WATERHEAD 1,200mm

SIZES 1L / 2L / 4L / 8L / 13L / 20L / 35L

COLOURS



30D ULTRA-SIL™



Ultra-Sil DRY SACK

Pack organisation and water resistance all in one.

FEATURES

- High Tenacity CORDURA® yarn creates a stronger and more durable fabric
- Slippery siliconised finish for easy packing

WATERHEAD 2,000mm

SIZES 1L / 2L / 4L / 8L / 13L / 20L / 35L

COLOURS





LIGHTWEIGHT

70D WATERPROOF FABRIC



LIGHTWEIGHT 70D DRY SACK

Our most versatile dry sack—light enough for backpacking and sturdy enough for water sports.

- FEATURES
- Interior white PU coating reflects light, making it easier to see contents
 - D-ring attachment point at the buckle

WATERHEAD 10,000mm

SIZES 1L / 2L / 4L / 8L / 13L / 20L / 35L

COLOURS



SLING DRY BAG

Over-the-shoulder convenience and waterproof protection for your gear.

- FEATURES
- Interior white PU coating reflects light, making it easier to see contents
 - Includes adjustable webbing strap for easy carrying

WATERHEAD 10,000mm

SIZES 10L / 20L

COLOURS



70D WATERPROOF FABRIC

eVent® WATERPROOF



EVAC DRY SACK

Versatile waterproof compressibility to fit bulky soft gear in awkward spaces—air compresses out, water can't get in.

- FEATURES
- Interior white PU coating reflects light, making it easier to see contents
 - eVent® base makes for easier operation as you can purge air even after it's rolled and closed.

WATERHEAD 10,000mm

SIZES 3L / 5L / 8L / 13L / 20L / 35L / 65L

COLOURS





LIGHTWEIGHT | **70D** WATERPROOF FABRIC | tpu

FIRST AID DRY SACK

Protects life-saving supplies from bad weather and abrasive environments.

FEATURES

- Emergency red fabric printed with the international standard for first aid kits (ISO 7010)
- Clear window for easy identification of contents

WATERHEAD 10,000mm

SIZES 1L / 3L / 5L

COLOURS



VIEW DRY SACK

Dry storage with a clear window for easy identification of its contents.

FEATURES

- TPU window is RF-welded to the fabric for a permanent bond that doesn't need seam tape

WATERHEAD 10,000mm

SIZES 1L / 2L / 4L / 8L / 13L / 20L / 35L

COLOURS





HEAVY DUTY | 210D STOPPER FABRIC tpu



STOPPER DRY BAG

Fully welded construction for a durable yet lightweight dry bag you can trust.

- FEATURES
- All welded construction for permanently sealed seams
 - Durable and smooth water shedding exterior

WATERHEAD 10,000mm+

SIZES 5L / 8L / 13L / 20L / 35L / 65L

COLOURS



CLEAR STOPPER DRY BAG

Rugged yet lightweight with a transparent TPU body to find gear quickly.

- FEATURES
- Optic grade clear TPU resists yellowing with age
 - Durable and smooth water shedding exterior
 - All welded construction for permanently sealed seams

WATERHEAD 10,000mm+

SIZES 5L / 8L / 13L / 20L / 35L / 65L

COLOURS



420D WATERPROOF FABRIC tpu



BIG RIVER DRY BAG

This supple but strong fabric makes for easier packing and stowage while still offering class-leading abrasion and water resistance.

- FEATURES
- Durable lash loops provide versatility of attachment options
 - Oval base resists rolling—it stays where you put it

WATERHEAD 10,000mm+

SIZES 3L / 5L / 8L / 13L / 20L / 35L / 65L

COLOURS





HEAVY DUTY | **600D** HYDRAULIC FABRIC

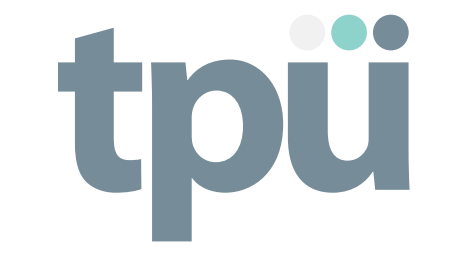

HYDRAULIC DRY BAG

Engineered for strength and ultimate durability—it's the gladiator of dry bags.

FEATURES

- Polyether chemistry eliminates the possibility of delamination
- Welded construction for permanently sealed waterproof seams
- Heavy-duty lash loops for secure attachment

WATERHEAD 30,000mm+

SIZES 20L / 35L / 65L

COLOURS



HYDRAULIC DRY PACK with Harness

A super heavy-duty drypack ideal for portaging and canyon runs.

FEATURES

- Comfortable, quick drying EVA foam straps and air mesh harness
- Waist strap (35L) or hip belt (65-120L) helps support the load when the pack is filled

WATERHEAD 30,000mm+

SIZES 35L / 65L / 90L / 120L

COLOURS





WATERPROOF ACCESSORY CASES

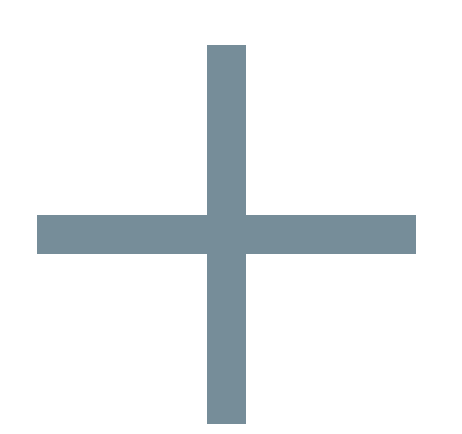

OUR WATERPROOF ACCESSORY CASES FEATURE:

WATERTIGHT

Totally welded construction.

INDIVIDUALLY TESTED

Waterproof and dust-proof.

TPU MATERIAL

UV and yellowing resistant TPU for superior, long lasting clarity.





TPU GUIDE MAP CASE

It's hard to read a wet map—keep yours dry and legible with this waterproof, foldable and durable map case.

FEATURES

- Low profile “sandwich bag” closure lets you fold the case into quarters (or smaller) to easily fit into a jacket pocket.

SIZES S / M / L

COLOURS



TPU GUIDE ACCESSORY CASE

Keep your essential accessories dry and accessible.

FEATURES

- Meets IPX8 testing standards of being waterproof at 10 metres for one hour
- Touch-screen compatible TPU material allows device to work inside case

SIZES S / M / L

COLOURS



WATERPROOF MAP CASE

Waterproof protection for your documents no matter the situation.

FEATURES

- Watertight roll top closure to keep your map protected from the elements

SIZES S / L

COLOURS

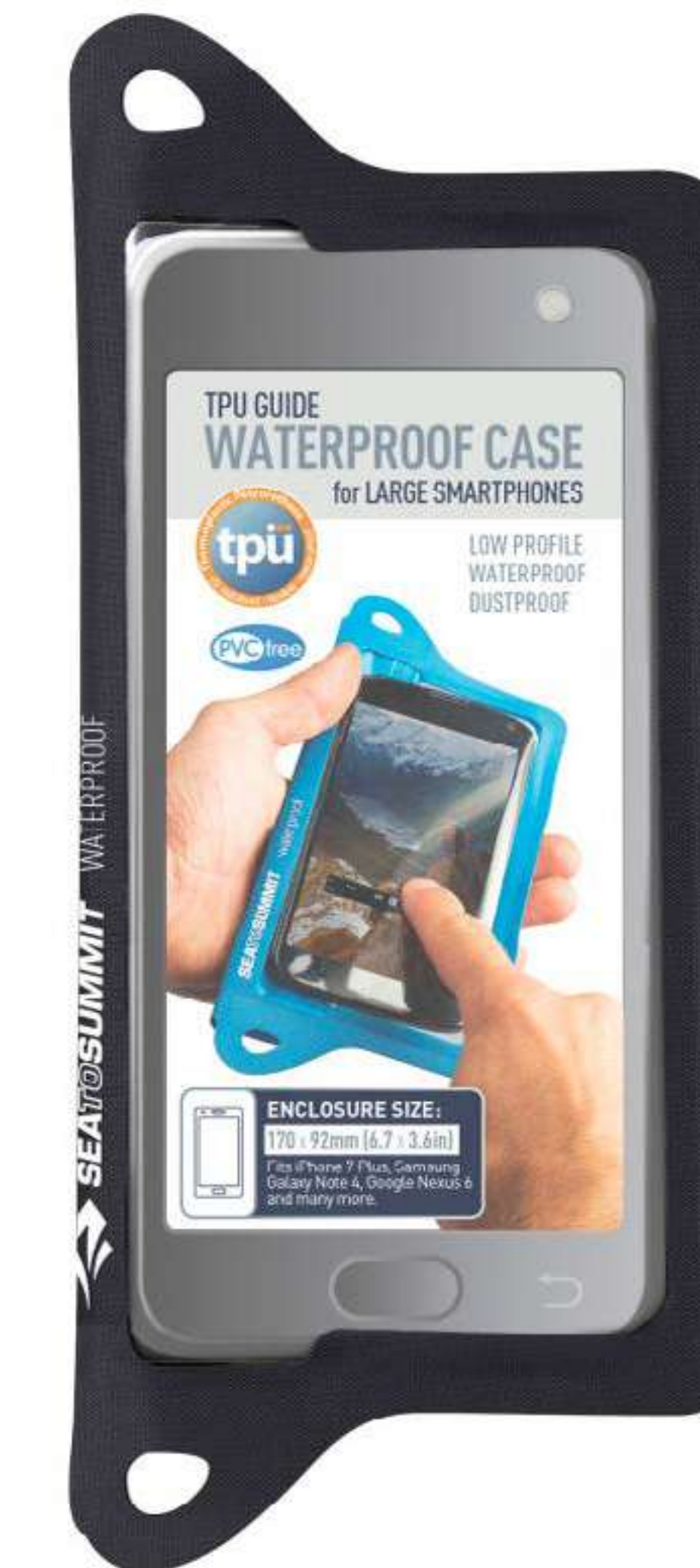

TPU GUIDE WATERPROOF PHONE CASE

Low-profile, strong and flexible waterproof case for Smartphones.

FEATURES

- Meets IPX8 testing standards—waterproof at 10 metres for one hour
- Touch-screen compatible TPU material allows device to work inside case





SIZES R / XL

COLOURS









COMPRESSION DRY BAGS

PRODUCT NAME	CODE	SIZE	DIMENSIONS	BASE	WEIGHT	COLOUR	RRP
 eVent® Dry Compression Sack	ADCXS	XS	ø15 x 35cm ø13.8 x 5.9 in	Round	107g 3.8 oz		
	ADCSS	Small	ø18 x 40cm ø7.1 x 15.8 in		129g 4.6 oz		
	ADCSM	Medium	ø20 x 46cm ø7.9 x 18.1 in		148g 5.2 oz		
	ADCSL	Large	ø23 x 50cm ø9.1 x 19.7 in		168g 5.9 oz		
	ADCSXL	XL	ø27 x 58cm ø10.6 x 22.8 in		210g 7.4 oz		
 Ultra-Sil eVent® Dry Compression Sack	AUCDS2XS	XXS	ø13 x 25cm ø5.1 x 9.8 in	Round	50g 1.8 oz		
	AUCDSXS	XS	ø15 x 30cm ø5.9 x 13.8 in		56g 2 oz		
	AUCDSS	Small	ø18 x 40cm ø7.1 x 15.8 in		75g 2.6 oz		
	AUCDSM	Medium	ø20 x 46cm ø7.9 x 18.1 in		90g 3.2 oz		
	AUCDSL	Large	ø23 x 50cm ø9.1 x 19.7 in		100g 3.5 oz		



















ULTRA LIGHT DRY BAGS

PRODUCT NAME	CODE	SIZE	DIMENSIONS	BASE	WEIGHT	COLOUR	RRP
 Ultra-Sil Nano Dry Sack	AUNDS1	1L	24 x 13 x 7.5cm 9.5 x 5.1 x 3 in	Oval	13g 0.5 oz		
	AUNDS2	2L	28.5 x 15 x 9.5cm 11.2 x 5.9 x 3.7 in		16g 0.6 oz		
	AUNDS4	4L	33 x 17 x 11.2cm 13 x 6.7 x 4.4 in		19g 0.7 oz		
	AUNDS8	8L	47 x 20 x 15cm 18.5 x 7.9 x 5.9 in		24g 0.8 oz		
	AUNDS13	13L	52 x 26 x 16.5cm 20.5 x 10.2 x 6.5 in		28g 1 oz		
	AUNDS20	20L	63 x 26 x 20cm 24.8 x 10.2 x 7.9 in		36g 1.3 oz		
	AUNDS35	35L	70 x 31 x 25cm 27.6 x 12.2 x 9.8 in		46g 1.6 oz		
 Ultra-Sil Dry Sack	AUDS1	1L	ø10.5 x 22.5cm ø4.3 x 9.4 in	Round	20g 0.7 oz		
	AUDS2	2L	ø12.5 x 28cm ø5.1 x 11.4 in		23g 0.8 oz		
	AUDS4	4L	ø15 x 33cm ø5.9 x 13 in		26g 0.9 oz		
	AUDS8	8L	ø17.5 x 45cm ø6.7 x 18 in		30g 1.1 oz		
	AUDS13	13L	ø20 x 51.5cm ø8.6 x 21 in		40g 1.4 oz		
	AUDS20	20L	ø24 x 60cm ø10 x 24 in		50g 1.8 oz		
	AUDS35	35L	ø29 x 70cm ø12 x 27 in		65g 2.3 oz		



LIGHTWEIGHT DRY BAGS

PRODUCT NAME	CODE	SIZE	DIMENSIONS	WEIGHT	BASE	COLOUR	RRP
 Lightweight 70D Dry Sack	ADS1	1L	ø10.5 x 22.5cm ø4.3 x 9.4 in	30g 1.1 oz	Round		
	ADS2	2L	ø12.5 x 25.8cm ø5.1 x 11.4 in	38g 1.3 oz			
	ADS4	4L	ø15 x 29.5cm ø5.9 x 13 in	44g 1.6 oz			
	ADS8	8L	ø17 x 41.5cm ø6.7 x 18 in	58g 2 oz			
	ADS13	13L	ø20 x 48cm ø8.6 x 21 in	72g 2.5 oz			
	ADS20	20L	ø23 x 58cm ø10 x 24 in	86g 3 oz			
	ADS35	35L	ø27.5 x 66cm ø12 x 27 in	115g 4.1 oz			
 Lightweight 70D Dry Sack 3-Piece Set	ASETDSM	Small			Round	1L  2L  4L 	
	ASETDSMED	Medium				4L  8L  13L 	
	ASETDSMEDBLK		4L  8L  13L 				
 Sling Dry Bag	ASBAG10L	10L	47 x 19 x 12.5cm 18.5 x 7.5 x 4.9 in	90g 3.2 oz	Oval		
	ASBAG20L	20L	61 x 27 x 17cm 24 x 10.6 x 6.7 in	119g 4.2 oz			
 eVac Dry Sack	AEDS3	3L	28 x 17 x 11cm 11 x 6.7 x 4.3 in	42g 1.5 oz	Oval		
	AEDS5	5L	39 x 17 x 11cm 15.4 x 6.7 x 4.3 in	48g 1.7 oz			
	AEDS8	8L	44 x 21 x 13cm 17.3 x 8.3 x 5.1 in	58g 2 oz			
	AEDS13	13L	51 x 23 x 15cm 20.1 x 9.1 x 5.9 in	69g 2.4 oz			
	AEDS20	20L	56 x 27 x 18cm 22.1 x 10.6 x 7.1 in	86g 3 oz			
AEDS35	35L	70 x 33 x 21cm 27.6 x 13 x 8.3 in	112g 4 oz				
AEDS65	65L	85 x 38 x 25cm 33.5 x 15 x 9.8 in	148g 5.2 oz				



LIGHTWEIGHT DRY BAGS

PRODUCT NAME	CODE	SIZE	DIMENSIONS	WEIGHT	BASE	COLOUR	RRP
First Aid Dry Sack	AFADS1	Day	23 x 13 x 7cm 9.1 x 5.1 x 2.8 in	32g 1.1 oz			
	AFADS3	Overnight	27 x 17 x 11cm 10.6 x 6.7 x 4.3 in	47g 1.7 oz	Oval		
	AFADS5	Expedition	30 x 23 x 12cm 11.8 x 9.1 x 4.7 in	53g 1.9 oz			
View Dry Sack	AVDS1	1L	23 x 12 x 7.5cm 9.1 x 4.7 x 3 in	32g 1.1 oz			
	AVDS2	2L	28 x 14 x 9.5cm 11 x 5.5 x 3.7 in	39g 1.4 oz			
	AVDS4	4L	32 x 17 x 12cm 12.6 x 6.7 x 4.7 in	48g 1.7 oz			
	AVDS8	8L	44 x 20 x 13cm 17.3 x 7.9 x 5.1 in	62g 2.2 oz	Oval		
	AVDS13	13L	51 x 23 x 15cm 20.1 x 9.1 x 5.9 in	76g 2.7 oz			
	AVDS20	20L	60 x 26 x 17cm 23.6 x 10.2 x 6.7 in	96g 3.4 oz			
	AVDS35	35L	68 x 32 x 21cm 26.8 x 12.6 x 8.3 in	130g 4.6 oz			



HEAVY DUTY DRY BAGS

PRODUCT NAME	CODE	SIZE	DIMENSIONS	BASE	WEIGHT	COLOUR	RRP
Stopper Dry Bag	ASDB5	5L	39 x 17 x 11cm 15.4 x 6.7 x 4.3 in	Oval	90g 3.2 oz		
	ASDB8	8L	44 x 21 x 13cm 17.3 x 8.3 x 5.1 in		105g 3.7 oz		
	ASDB13	13L	51 x 23 x 15cm 20.1 x 9.1 x 5.9 in		141g 5 oz		
	ASDB20	20L	60 x 27 x 17cm 23.6 x 10.6 x 6.7 in		186g 6.6 oz		
	ASDB35	35L	70 x 33 x 21cm 27.6 x 13 x 8.3 in		241g 8.5 oz		
	ASDB65	65L	85 x 38 x 25cm 33.5 x 15 x 9.8 in		333g 11.7 oz		
Clear Stopper Dry Bag	ASDB5CLRBK	5L	39 x 17 x 11cm 15.4 x 6.7 x 4.3 in	Oval	113g 4 oz		
	ASDB8CLRBK	8L	44 x 21 x 13cm 17.3 x 8.3 x 5.1 in		140g 4.9 oz		
	ASDB13CLRBK	13L	51 x 23 x 15cm 20.1 x 9.1 x 5.9 in		174g 6.1 oz		
	ASDB20CLRBK	20L	60 x 27 x 17cm 23.6 x 10.6 x 6.7 in		246g 8.7 oz		
	ASDB35CLRBK	35L	70 x 33 x 21cm 27.6 x 13 x 8.3 in		330g 11.6 oz		
	ASDB65CLRBK	65L	85 x 38 x 25cm 33.5 x 15 x 9.8 in		445g 15.7 oz		
Big River Dry Bag	ABRDB3	3L	28 x 17 x 11cm 11 x 7 x 4 in	Oval	70g 2.5 oz		
	ABRDB5	5L	39 x 17 x 11cm 15.4 x 6.7 x 4.3 in		96g 3.4 oz		
	ABRDB8	8L	44 x 21 x 13cm 17.3 x 8.3 x 5.1 in		106g 3.7 oz		
	ABRDB13	13L	51 x 23 x 15cm 20.1 x 9.1 x 5.9 in		128g 4.5 oz		
	ABRDB20	20L	60 x 27 x 17cm 23.6 x 10.6 x 6.7 in		184g 6.5 oz		
	ABRDB35	35L	70 x 33 x 21cm 27.6 x 13 x 8.3 in		239g 8.4 oz		
	ABRDB65	65L	85 x 38 x 25cm 33.5 x 15 x 9.8 in		293g 10.3 oz		
Hydraulic Dry Bag	AHYDB20	20L	60 x 27 x 17cm 23.6 x 10.6 x 6.7 in	Oval	435g 15.3 oz		
	AHYDB35	35L	70 x 33 x 21cm 27.6 x 13 x 8.3 in		592g 20.9 oz		
	AHYDB65	65L	85 x 38 x 25cm 33.5 x 15 x 9.8 in		760g 26.8 oz		



DRY PACKS

PRODUCT NAME	CODE	SIZE	DIMENSIONS	BASE	WEIGHT	COLOUR	RRP
Hydraulic Dry Pack with Harness	AHYDBHS35	35L	70 x 33 x 21cm 27.6 x 13 x 8.3 in	Oval	1140g 47.3 oz		
	AHYDBHS65	65L	85 x 38 x 25cm 33.5 x 15 x 9.8 in		1320g 46.6 oz		
	AHYDBHS90	90L	100 x 42 x 30cm 39.4 x 16.5 x 11.8 in		1520g 53.6 oz		
	AHYDBHS120	120L	113 x 47 x 32cm 44.5 x 18.5 x 12.6 in		1800g 63.5 oz		

WATERPROOF ACCESSORY CASES

PRODUCT NAME	CODE	SIZE	DIMENSIONS	WEIGHT	COLOUR	RRP
Waterproof Map Case	AWMCS	Small	30 x 22cm 11.8 x 8.7 in	60g 2.1 oz		
	AWMCL	Large	33 x 28cm 13 x 11 in	80g 2.8 oz		
TPU Guide Map Case	AMAPTPUS	Small	27.5 x 21cm 10.8 x 8.3 in	56g 2 oz		
	AMAPTPUM	Medium	30 x 28cm 11.8 x 11 in	78g 2.8 oz		
	AMAPTPUL	Large	39.5 x 33cm 15.6 x 13 in	102g 3.6 oz		
TPU Guide Accessory Case	AACTPUSBK	Small	13.5 x 10.5cm 5.3 x 4.1 in	22g 0.8 oz		
	AACTPUMBK	Medium	22.5 x 13cm 8.9 x 5.1 in	28g 1 oz		
	AACTPULBK	Large	21.5 x 15cm 8.5 x 5.9 in	34g 1.2 oz		
TPU Guide Waterproof Phone Case	ACTPUSMARTPHBK	Regular	19.5 x 7.5cm 5.8 x 3.3 in	27g 1 oz		
	ACTPUSPXLBK	XL	23 x 10cm 6.7 x 3.6 in	30g 1.1 oz		



STUFF + COMPRESSION SACKS

Save space and keep your gear organised with our extensive range of mesh sacks, stuff sacks and compression sacks.



ROBUST MATERIALS

Lightweight yet tough materials for long-lasting reliability.

STRONG + DURABLE

Double stitched and reinforced seams for greater strength and durability.

EASY ORGANISATION

Colour coded sizes make it easy to organise your gear sacks.



EXPLORE THE RANGE

COMPRESSION SACKS



Ultra-Sil
COMPRESSION SACK



NYLON
COMPRESSION SACK

STUFF SACKS



Ultra-Sil
STUFF SACK



NYLON
STUFF SACK

MESH STUFF SACKS



ULTRA-MESH
STUFF SACK



MESH
STUFF SACK

ACCESSORY SACKS



TravellingLight
STUFF SACK SET



PEG + UTENSIL
STUFF SACK



COMPRESSION SACKS

30D ULTRA-SIL™

CORDURA™
FABRIC

Ultra-Sil COMPRESSION SACK

Compress your gear without adding weight to your load.

FEATURES

- Designed to compress to a third of the volume—perfect for soft and bulky items
- Four straps allows even compression and helps eliminate bulging

SIZES XXS / XS / S / M / L / XL

COLOURS   



70D WATERPROOF FABRIC

NYLON COMPRESSION SACK

Durable and reliable compression sack to maximise space in your pack.

FEATURES

- Flip-top-lid design prevents strap tangling
- Four straps allows even compression and helps eliminate bulging

SIZES XXS / XS / S / M / L / XL

COLOURS   





STUFF SACKS

30D ULTRA-SIL™

CORDURA™
FABRIC



Ultra-Sil STUFF SACK

Ultralight and slippery pack organisation for the savvy packer.

FEATURES

- Fabric has a slippery finish for easy packing

SIZES XXS / XS / S / M / L / XL / XXL

COLOURS ● ● ● ●



70D WATERPROOF FABRIC



NYLON STUFF SACK

Pack organisation built to last.

FEATURES

- Unique tear-proof drawcord top opening
- Reinforced pull handle on bottom

SIZES XXS / XS / S / M / L / XL / XXL

COLOURS ● ● ●





MESH STUFF SACKS | 15D ULTRA-MESH™



ULTRA-MESH STUFF SACK

Featherlight and perfect for organising gear in your pack or travel bag—they're our lightest storage and organisation solution.

FEATURES

- Black mesh for good visibility
- Ultra-Sil Nano drawcord throat for smooth operation

SIZES XXS / XS / S / M / L / XL / XXL

TRIM COLOURS ● ● ●



150D MESH FABRIC



MESH STUFF SACK

Using the same burly construction details as our bomb-proof stuff sacks, they're ideal for storing sleeping bags, transporting wet stuff, air drying gear at camp or collecting molluscs!

FEATURES

- Perfect for items you need to see easily or when you don't want to trap odours
- Drawcord sleeve in assorted colours for ease of organisation

SIZES XXS / XS / S / M / L / XL / XXL

TRIM COLOURS ● ● ●





ACCESSORY STUFF SACKS

30D ULTRA-SIL™



TravellingLight STUFF SACK SET

Keep even your smallest items organised in your travel luggage, backpack or at home.

FEATURES

- Perfect for separating clothes, food or gadgets

SIZES S / M / L



Ultra-Sil PEG AND UTENSIL BAG

Protect your equipment and keep sharp-ended gear separate and organised.

FEATURES

- Reinforced base for durability

COLOURS













COMPRESSION SACKS

PRODUCT NAME	CODE	SIZE	DIMENSIONS	WEIGHT	COLOUR	RRP
Ultra-Sil Compression Sack	ASNCXS	XS	ø15 x 35cm ø6 x 14 in	58g 2 oz		
	ASNCSS	Small	ø18.5 x 39.5cm ø7 x 16 in	66g 2.3 oz		
	ASNCM	Medium	ø20 x 46cm ø8 x 18 in	78g 2.8 oz		
	ASNCSL	Large	ø23 x 50cm ø9 x 20 in	94g 3.3 oz		
	ASNCXL	XL	ø27 x 58cm ø10.5 x 23 in	108g 3.8 oz		
Nylon Compression Sack	ACSXS	XS	ø15 x 34cm ø5.5 x 14 in	110g 3.9 oz		
	ACSS	Small	ø18 x 40cm ø7 x 16 in	128g 4.5 oz		
	ACSM	Medium	ø20 x 46cm ø8 x 18 in	156g 5.5 oz		
	ACSL	Large	ø23 x 50cm ø9 x 20 in	175g 6.2 oz		
	ACSXL	XL	ø27 x 58cm ø10.5 x 23 in	215g 7.6 oz		



STUFF SACKS

PRODUCT NAME	CODE	SIZE	DIMENSIONS	WEIGHT	COLOUR	RRP
 Ultra-Sil Stuff Sack	ASN240XXS	XXS	ø11 x 22cm ø4.3 x 8.7 in	11g 0.4 oz		
	ASN240XS	XS	ø14 x 27cm ø5.5 x 10.6 in	14g 0.5 oz		
	ASN240S	Small	ø17 x 30cm ø6.7 x 11.8 in	17g 0.6 oz		
	ASN240M	Medium	ø18 x 34cm ø7.1 x 13.4 in	20g 0.7 oz		
	ASN240L	Large	ø21 x 40cm ø8.3 x 15.8 in	28g 1 oz		
	ASN240XL	XL	ø24 x 45cm ø9.5 x 17.7 in	34g 1.2 oz		
	ASN240XXL	XXL	ø26 x 55cm ø10.2 x 21.7 in	40g 1.4 oz		
Ultra-Sil Stuff Sack 3-Piece Set	ASETUSS				XXS  XS  S 	
 Nylon Stuff Sack	ASS/XXS	XXS	ø11 x 21cm ø4.3 x 8.3 in	28g 1 oz		
	ASS/XS	XS	ø14 x 27cm ø5.5 x 10.6 in	30g 1.1 oz		
	ASS/S	Small	ø17 x 30cm ø6.7 x 11.8 in	37g 1.3 oz		
	ASS/M	Medium	ø18.5 x 38cm ø7.3 x 15 in	40g 1.4 oz		
	ASS/L	Large	ø23 x 42cm ø9.1 x 16.5 in	52g 1.8 oz		
	ASS/XL	XL	ø24 x 45cm ø9.5 x 17.7 in	61g 2.2 oz		
	ASS/XXL	XXL	ø26 x 55cm ø10.2 x 21.7 in	78g 2.8 oz		



MESH STUFF SACKS

PRODUCT NAME	CODE	SIZE	DIMENSIONS	WEIGHT	TRIM COLOUR	RRP
Ultra-Mesh Stuff Sack	AUMSSXSBL	XXS	ø11 x 22cm ø4.3 x 8.7 in	6g 0.2 oz		
	AUMSSXSLI	XS	ø14 x 27cm ø5.5 x 10.6 in	8g 0.3 oz		
	AUMSSSOR	Small	ø17 x 30cm ø6.7 x 11.8 in	10g 0.4 oz		
	AUMSSMBL	Medium	ø18 x 34cm ø7.1 x 13.4 in	11g 0.4 oz		
	AUMSSLLI	Large	ø21 x 40cm ø8.3 x 15.8 in	14g 0.5 oz		
	AUMSSXLOR	XL	ø24 x 45cm ø9.5 x 17.7 in	17g 0.6 oz		
	AUMSSXXLBL	XXL	ø26 x 55cm ø10.2 x 21.7 in	20g 0.7 oz		
Mesh Stuff Sack	AM/XXSBL	XXS	ø11 x 22cm ø4.3 x 8.7 in	30g 1.1 oz		
	AM/XSGN	XS	ø14 x 27cm ø5.5 x 10.6 in	38g 1.3 oz		
	AM/SRD	Small	ø17 x 30cm ø6.7 x 11.8 in	46g 1.6 oz		
	AM/MBL	Medium	ø18 x 34cm ø7.1 x 13.4 in	52g 1.8 oz		
	AM/LGN	Large	ø21 x 40cm ø8.3 x 15.8 in	70g 2.5 oz		
	AM/XLRD	XL	ø27 x 45cm ø9.5 x 17.7 in	80g 2.8 oz		
	AM/XXLBL	XXL	ø26 x 55cm ø10.2 x 21.7 in	98g 3.5 oz		
Mesh Stuff Sack 3-Piece Set	ASETMSS				XXS XS S	

ACCESSORY STUFF SACKS

PRODUCT NAME	CODE	DIMENSIONS	WEIGHT	COLOUR	RRP
TravellingLight Stuff Sack Set	ATLSSS		27g 1 oz	S M L	
Ultra-Sil Peg and Utensil Bag	ABAGPEG	ø10 x 28cm ø3.9 x 11 in	6g 0.2 oz		

CARE + PROTECTION

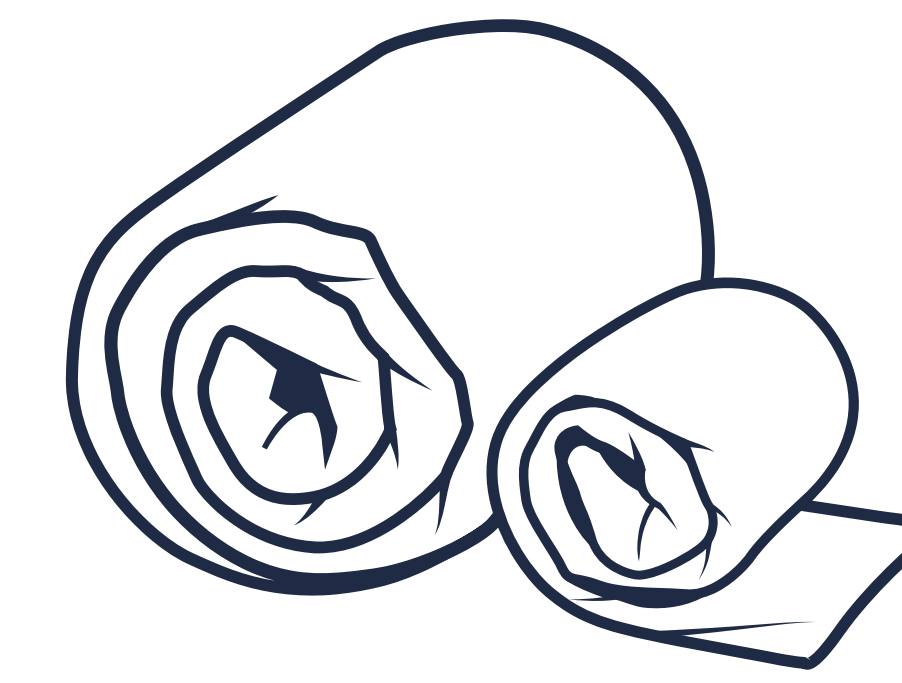

TOWELS

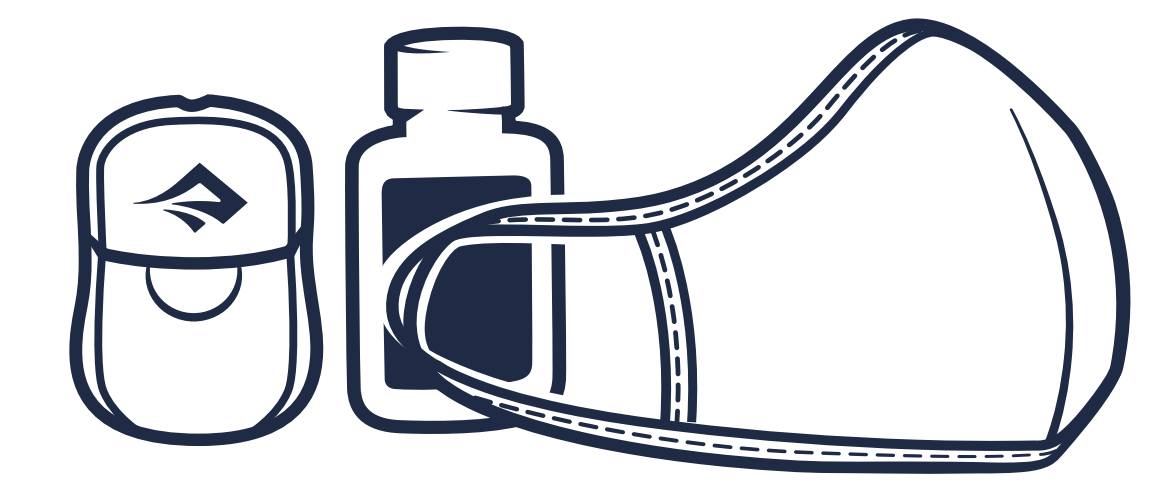

PERSONAL CARE

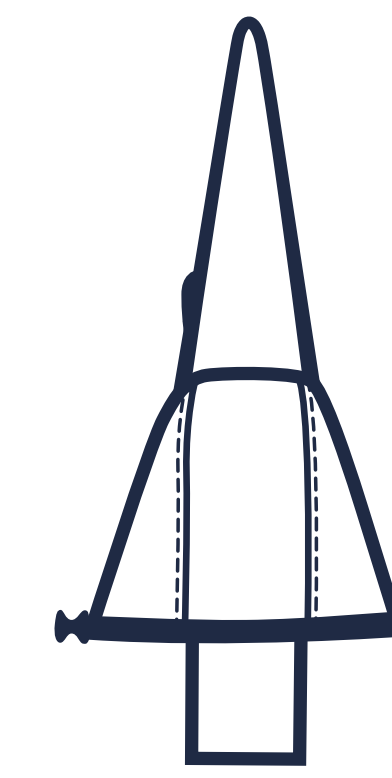

UTILITY + CONVENIENCE

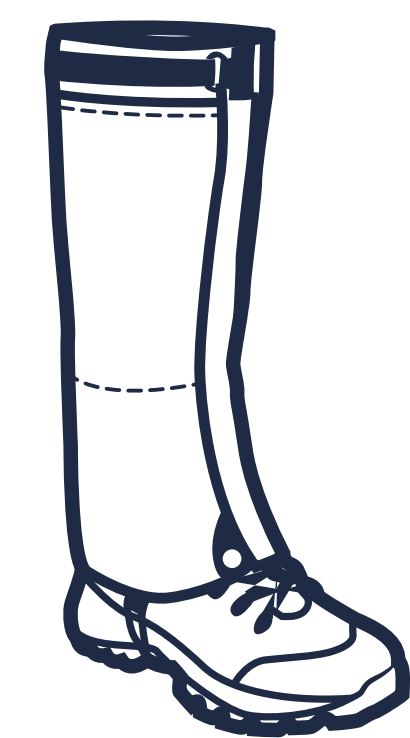

GAITERS

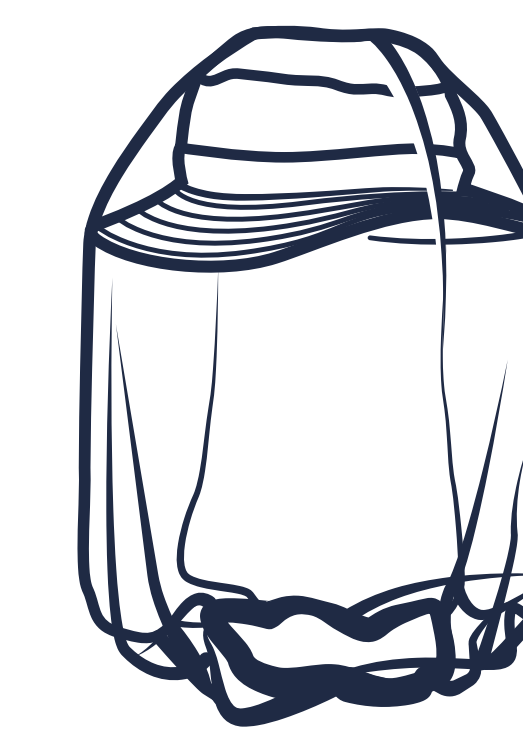

INSECT PROTECTION
CLOTHING

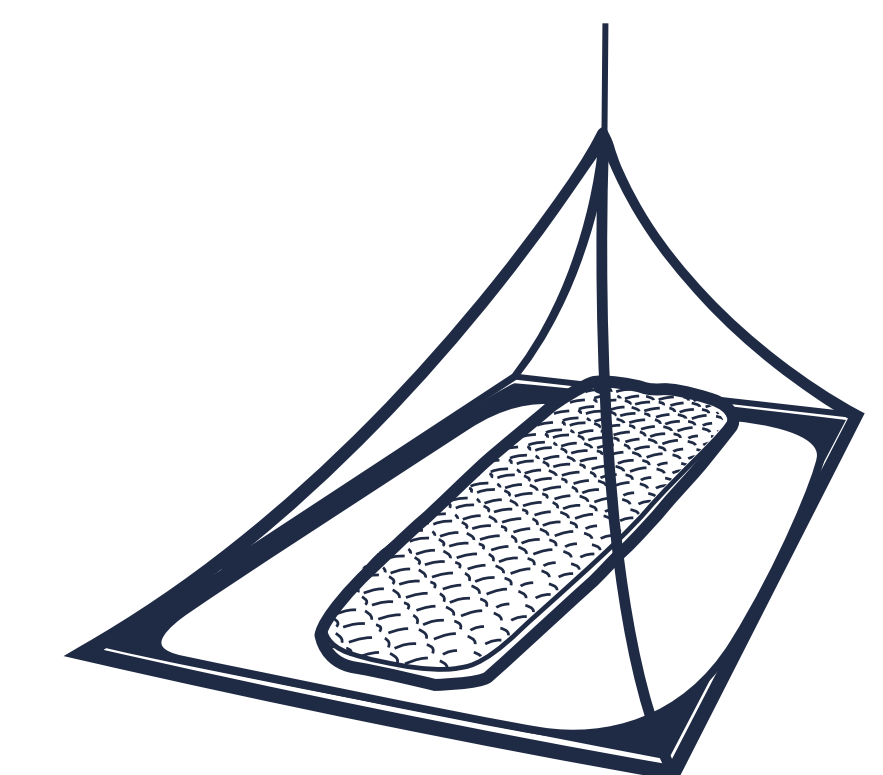

INSECT PROTECTION
SHELTERS



PACK + RAIN PROTECTION

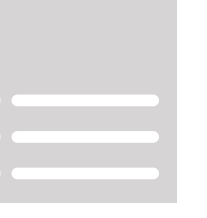



TOWELS THAT TRAVEL

Our packable towels earn their place in your backpack or carry-on. They're lighter, more compact and will dry faster to keep you on the move.



DRY+

DRY+ FABRIC

A fast-drying, recycled fabric that won't hold onto water like traditional cotton towels.

NEW COLOURS + PATTERNS

Inspired by the natural landscape.

HANDY STORAGE

All towels come with a handy storage sack or case to make packing easier.

EXTRA ABSORBANT

Technical fabrics hold up to six times their own weight in water.

EASY DRYING

Hang Loop with press stud closure for easy drying.

EASY CARE



All of our towels are machine washable.

SOFT HAND-FEEL

Lightweight technical materials with soft finishes.



EXPLORE THE RANGE

LIGHTWEIGHT			DELUXE
 <p>UPDATED</p> <p>DRYLITE TOWEL</p>	 <p>UPDATED</p> <p>AIRLITE TOWEL</p>	 <p>UPDATED</p> <p>POCKET TOWEL</p>	 <p>UPDATED</p> <p>TEK TOWEL</p>

UPDATED SIZING

Consistent sizing across all models and the addition of a new XXL size in the Drylite range.





NEW COLOURS + PATTERNS

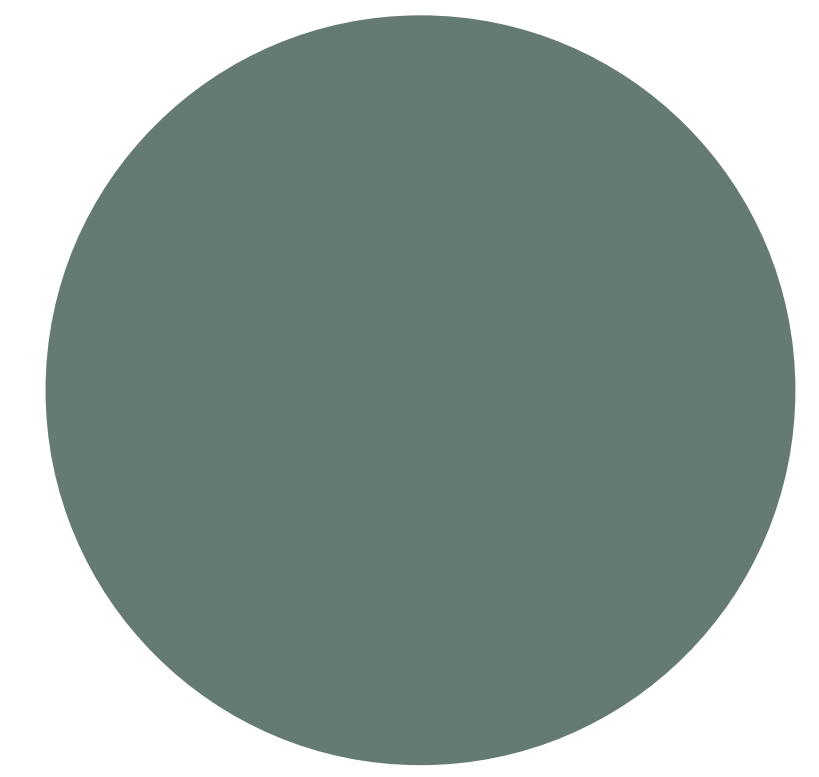

SAGE

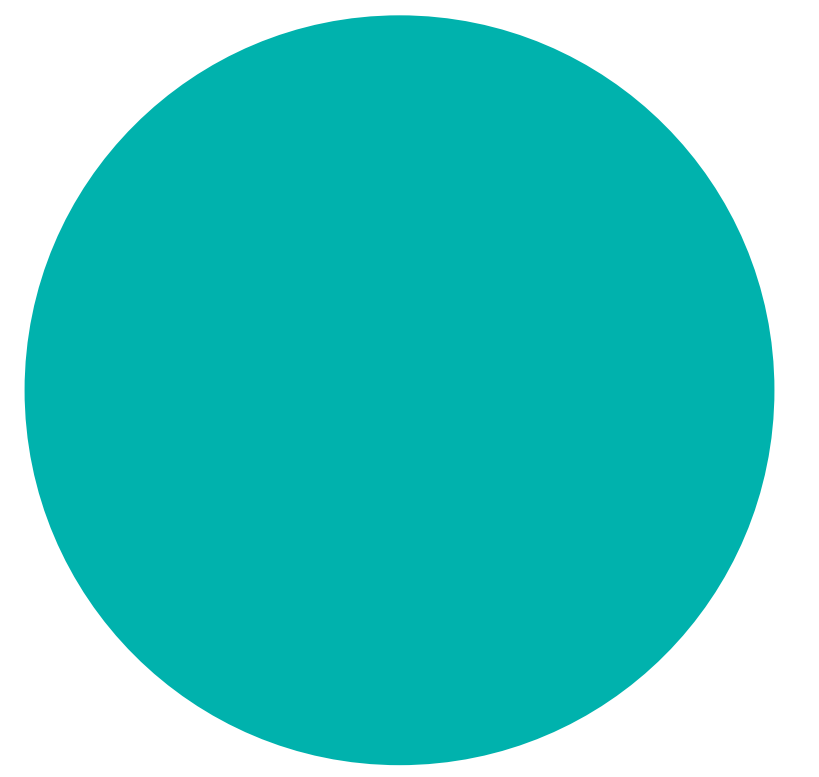

BALTIC

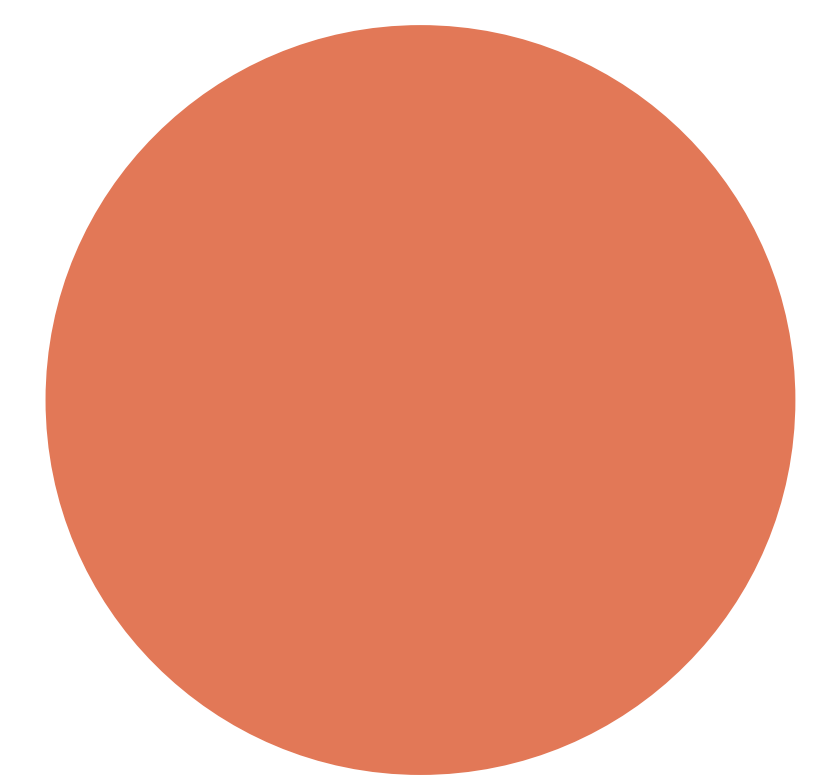

OUTBACK

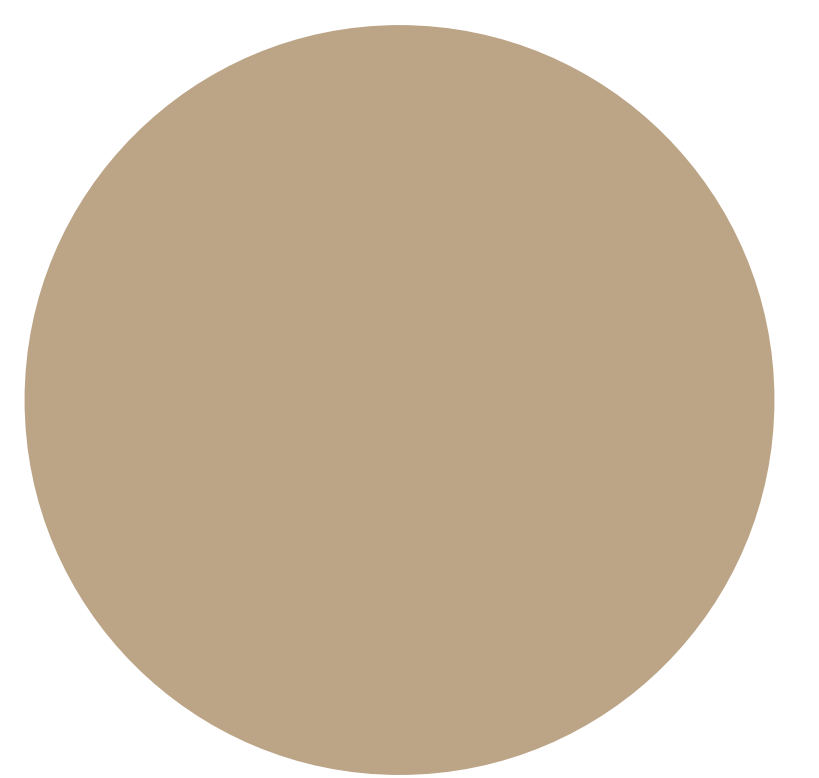

DESERT

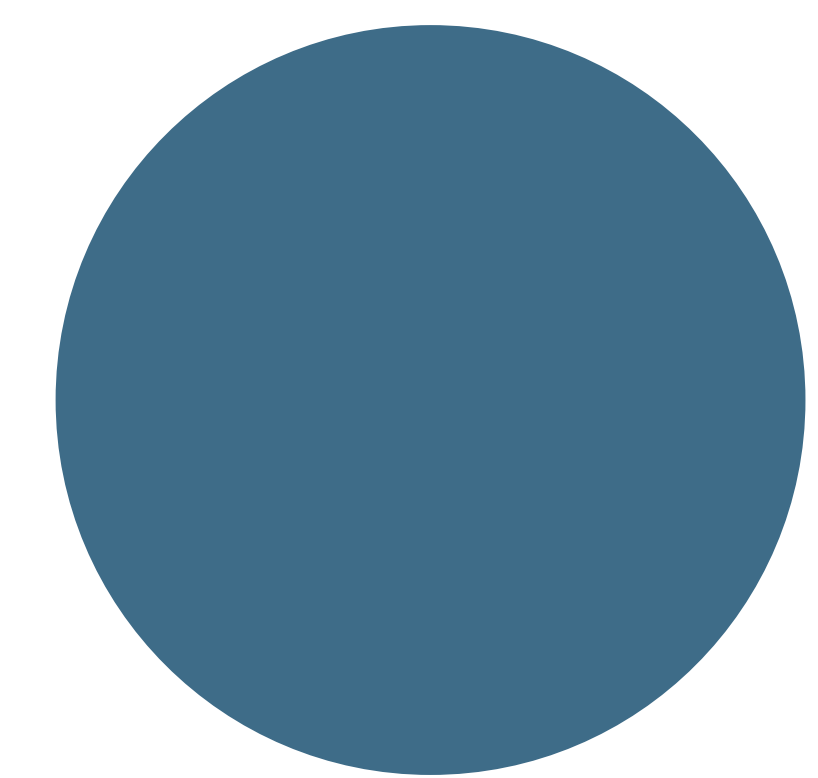

MOONLIGHT

NEW PATTERNS AVAILABLE IN DRYLITE TOWELS



ATLANTIC WAVE



OUTBACK SUNSET



DESERT WIND



BEACH BLUE



DRYLITE TOWEL

The perfect hostel travel towel—compact, super soft, absorbent and fast-drying.

FEATURES

- Suede woven fabric reduces weight and speeds up drying time, while still giving a soft hand feel.
- Remarkably absorbent and fast-drying
- Very packable—it's lighter and more compact than our Tek Towel

SIZES XS / S / M / L / XL / XXL

COLOURS





AIRLITE TOWEL

Lightweight, super compact and exceptionally fast drying, our minimalist Airlite Towel won't slow you down.

FEATURES

- 50% lighter than our Pocket Towel
- Perfect for sweat management when on the trail or during exercise.

SIZES XXS / S / M / L

COLOURS



TEK TOWEL

Super absorbent, quick drying towel with that at-home terrycloth feel.

FEATURES

- A classic terry towel knit fabric creates a soft, plush towel that can absorb over 6 times it's own weight in water.

SIZES XS / S / M / L / XL

COLOURS



POCKET TOWEL

Travel with one and you're home and dry in a jiffy.

FEATURES

- Absorbs up to three times its own weight in water

SIZES XS / S / M / L / XL

COLOURS





LIGHTWEIGHT TOWELS

PRODUCT NAME	CODE	SIZE	DIMENSIONS	WEIGHT	STORAGE	MATERIALS	COLOUR	RRP
Drylite Towel	ACP071031-03	XS	60 x 30cm 24 x 12 in	37g 1.3 oz	Mesh Faced Storage Pouch with Velcro Closure	Recycled Polyester - 80% Polyamide-20%		
	ACP071031-04	Small	80 x 40cm 32 x 16 in	62g 2.2 oz				
	ACP071031-05	Medium	100 x 50cm 40 x 20 in	100g 3.5 oz				
	ACP071031-06	Large	120 x 60cm 48 x 24 in	145g 5.1 oz				
	ACP071031-07	XL	150 x 75cm 60 x 30 in	230g 8.1 oz				
	NEW ACP071031-08	XXL	17 x 85cm 70 x 33.5 in	495g 17.5 oz				
Airlite Towel	ACP071011-02	XXS	36 x 36cm 14.2 x 14.2 in	12g 0.4 oz	Stuff Sack with Drawcord Closure	Recycled Polyester - 85% Polyamide -15%		
	ACP071011-04	Small	80 x 40cm 32 x 16 in	30g 1 oz				
	ACP071011-05	Medium	100 x 50cm 40 x 20 in	47g 1.7 oz				
	ACP071011-06	Large	120 x 60cm 48 x 24 in	67g 2.4 oz				
Pocket Towel	ACP071051-04	Small	80 x 40cm 32 x 16 in	58g 2 oz	EVA case with zipper closure	Recycled Polyester - 100%		
	ACP071051-05	Medium	100 x 50cm 40 x 20 in	80g 2.8 oz				
	ACP071051-06	Large	120 x 60cm 48 x 24 in	110g 3.9 oz				
	ACP071051-07	XLarge	150 x 75cm 60 x 30 in	175g 6.2 oz				

DELUXE TOWELS

PRODUCT NAME	CODE	SIZE	DIMENSIONS	WEIGHT	STORAGE	MATERIALS	COLOUR	RRP
Tek Towel	ACP072011-03	XS	60 x 30cm 24 x 12 in	80g 2.8 oz	EVA case with zipper closure	Recycled Polyester - 80% Polyamide-20%		
	ACP072011-04	Small	80 x 40cm 32 x 16 in	120g 4.2 oz				
	ACP072011-05	Medium	100 x 50cm 40 x 20 in	200g 7.1 oz				
	ACP072011-06	Large	120 x 60cm 48 x 24 in	285g 10.1 oz				
	ACP072011-07	XL	150 x 75cm 60 x 30 in	445g 15.7 oz				



PERSONAL CARE





EXPLORE THE RANGE

FACE MASKS	CLEANING WIPES	LIQUID SOAPS	PAPER SOAPS	SANITISERS
				





BARRIER FACE MASK

A thermo-formed and seamless design provides full nose and mouth coverage, while the elasticised ear loops keep the mask securely in place. Our non-medical face masks are equally comfortable for short trips to the store or longer commutes and travel.

FEATURES

- Stylish quilted three-layer construction
- Machine washable at 60°C and reusable
- For non-medical use

SIZES XS / S / R

COLOURS   





WILDERNESS WIPES

Wilderness Wipes will clean and refresh you when a shower, or even just water, isn't a possibility. The extra thick Veocel non-woven fibre is soft and gentle on your skin, pH balanced and readily compostable after use.

FEATURES

- Resealable packet

SIZES Compact / XL



SANITISING HAND WIPES

Use these extra thick Sanitising Hand Wipes to effectively kill germs and bacteria on your hands and surfaces around you. Unscented and pH balanced to be skin-friendly, the compact resealable packs come in two handy sizes—12 and 36 pieces.

FEATURES

- Kills 99.99% of germs

SIZES 12 / 36 pieces





UPDATED

WILDERNESS WASH

Our super-concentrated Wilderness Wash goes a long way—it's gentle on fabrics and skin but effective on dishes and laundry stains.

FEATURES

- Super-concentrated biodegradable formula
- Tough bottle with lid insert and secure cap, so it will not leak in your pack or bag
- Safe for personal use, pots, pans, clothes and outdoor gear

SIZES 50ml / 100ml / 250ml





UPDATED

TREK AND TRAVEL LIQUID SOAPS

Fitting Easily into cabin baggage or an expedition pack, our Trek & Travel Liquid Soaps will spruce up everything from hair and body to clothes. The made-to-travel, leak-proof bottle is TSA carry-on compliant and the biodegradable formula is environmentally friendly.

FEATURES

- Ideal for travelling and camping
- Concentrated formula

SIZES 100ml





TREK AND TRAVEL POCKET SOAPS

These palm-sized pocket soaps will spruce up everything from hair, to body, to clothes.

FEATURES

- Biodegradable and Environmentally friendly

SIZES 50 leaves

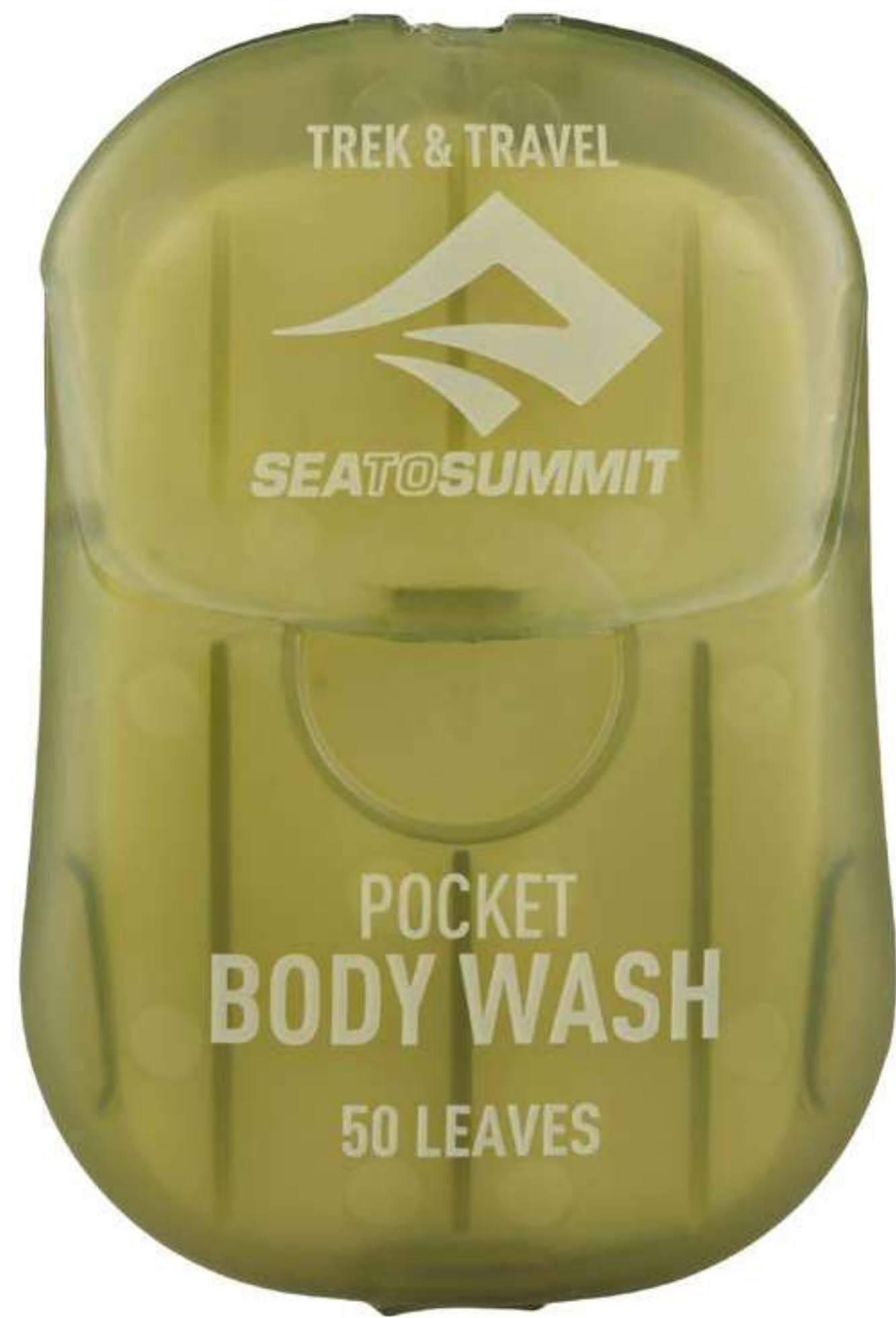

WILDERNESS WASH POCKET SOAP

Multi-purpose outdoors dry leaf wash—leak-free convenience anywhere.

FEATURES

- Fragrance-free and biodegradable

SIZES 50 leaves





HAND CLEANING GEL

Our Hand Cleaning Gel will leave your hands feeling fresh, gently fragrant and germ-free—without rinsing your hands. It’s been a staple of our popular Trek & Travel soap range for over a decade—and for good reason.

FEATURES

- Effective 70% alcohol formula
- Cleans hands without soap and water
- Fast-drying and non-sticky formulation
- Leakproof travel-friendly lid and reusable bottle

SIZES 50ml / 100ml





FACE MASKS

PRODUCT NAME	CODE	SIZE	DIMENSIONS	WEIGHT	MATERIALS	COLOUR	RRP
Barrier Face Mask	ATLFMXS	XSmall	14.5 x 17 x 17cm 5.7 x 6.7 x 6.7 in				
	ATLFMSM	Small	14.5 x 16 x 16cm 5.7 x 6.3 x 6.3 in	10g 0.4 oz			
	ATLFMRG	Regular	12 x 10.5 x 10.5cm 4.7 x 4.1 x 4.1 in				

CLEANING WIPES

PRODUCT NAME	CODE	SIZE	DIMENSIONS	WEIGHT	MATERIALS	RRP
Wilderness Wipes	AWWC	Compact 12 pack	20 x 16cm 8 x 6 in	93g 3.7 oz	Refer to the ingredients list on packaging	
	AHY4192-00121002	Compact 36 pack		292g 10.3 oz		
	AWWXL	XLarge 8 pack	30 x 20cm 12 x 8 in	122g 4.5 oz		
Hand Sanitising Wipes	AHY4195-00121001	12 pack			Refer to the ingredients list on packaging	
	AHY4195-00121002	36 pack				

LIQUID SOAPS



PRODUCT NAME	CODE	SIZE	DIMENSIONS	WEIGHT	MATERIALS	RRP
Wilderness Wash	AHY4029-00121003	50ml	11 x 4.5 x 2.5cm 3 x 1.7 x 1 in	63g 2.2 oz	Refer to the ingredients list on packaging	
	AHY4029-00121004	100ml	11 x 6 x 2.5cm 4.2 x 2.4 x 1 in	115g 4.1 oz		
	AWW250	250ml	14 x 8 x 4cm 5.5 x 3.1 x 1.6 in	295g 10.4 oz		
Wilderness Wash 50mL POS Master Pack	AHY1029-00160001	48 Units				
Wilderness Wash Citronella	AHY4029-00121005	50ml	11 x 4.5 x 2.5cm 3 x 1.7 x 1 in	63g 2.2 oz	Refer to the ingredients list on packaging	
	AHY4029-00121006	100ml	11 x 6 x 2.5cm 4.2 x 2.4 x 1 in	115g 4.1 oz		
	AWWC250	250ml	14 x 8 x 4cm 5.5 x 3.1 x 1.6 in	295g 10.4 oz		



LIQUID SOAPS

PRODUCT NAME	CODE	SIZE	DIMENSIONS	WEIGHT	MATERIALS	RRP
Trek & Travel Liquid Body Wash	ACP063021-041401					
 Trek & Travel Liquid Conditioning Shampoo	ACP063041-041402	100ml	11 x 6 x 2.5cm 4.2 x 2.4 x 1 in	115g 4.1 oz	Refer to the ingredients list on packaging	
Trek & Travel Liquid Laundry Wash	ACP063051-041403					

PAPER SOAPS

PRODUCT NAME	CODE	SIZE	DIMENSIONS	WEIGHT	MATERIALS	RRP
Trek & Travel Pocket Body Wash	ATTPBW					
 Trek & Travel Pocket Conditioning Shampoo	ATTPCS	50 leaves	6.5 x 4.5 x 1.5cm 2.6 x 1.8 x 0.6 in	14g 0.5 oz	Refer to the ingredients list on packaging	
Trek & Travel Pocket Hand Wash	ATTPHW					
Trek & Travel Pocket Laundry Wash	ATTPLW					
 Wilderness Wash Pocket Soap	APSOAP	50 leaves	6.5 x 4.5 x 1.5cm 2.6 x 1.8 x 0.6 in	14g 0.5 oz	Refer to the ingredients list on packaging	
Wilderness Wash Pocket Soap POS Master Pack	AHY2033-00160001	80 Units				

SANITISERS

PRODUCT NAME	CODE	SIZE	WEIGHT	MATERIALS	RRP
Hand Cleaning Gel	AHY1030-03030004	50mL			
 Hand Cleaning Gel 100mL POS Master Pack	AHY1030-03040005	100mL		Refer to the ingredients list on packaging	
Hand Cleaning Gel 100mL POS Master Pack	AHY1030-03100009	22 Units			
Hand Cleaning Gel 50mL POS Master Pack	AHY1030-03100010	48 Units			



CARE + PROTECTION - UTILITY + CONVENIENCE



UTILITY + CONVENIENCE





EXPLORE THE RANGE

WASH UP SOLUTIONS



CLOTHESLINE



POCKET SHOWER

LEAVE NO WASTE



POCKET TROWEL
ALLOY



POCKET TROWEL
NYLON 66



Ultra-Sil OUTHOUSE



THE CLOTHESLINE

Quick and easy to set-up no stretch, no peg, adjustable length clothesline.

FEATURES

- Clothesline measures 3.5 metres
- Dual cord with beads holds garments in place, even in the wind



POCKET SHOWER

Enjoy a well-earned eight minute shower at the end of a long sweaty day in the outdoors.

FEATURES

- Contoured shower head provides generous and even spray dispersion
- Simple and easy-to-use twist mechanism for turning on/off and for flow adjustment



70D WATERPROOF FABRIC





POCKET TROWEL ALLOY

Our super-strong Alloy Pocket Trowel is a durable, lightweight and compact carry-anywhere trekking trowel.

FEATURES

- Storage space in handle for a lighter or toilet paper



POCKET TROWEL NYLON 66

Minimise your backcountry impact with this compact and lightweight camping trowel.

FEATURES

- Storage space in handle for lighter or toilet paper
- Withstands extremely cold temperatures





Ultra-Sil OUTHOUSE

There's nothing more useless than wet toilet paper—keep yours dry and accessible.



FEATURES

- Toilet paper is suspended inside by a stiffening rod that allows the paper to dispense smoothly
- Accommodates full size toilet roll



30 D ULTRA-SIL™



**WASH UP SOLUTIONS**

PRODUCT NAME	CODE	SIZE	WEIGHT	MATERIALS	RRP
 The Clothesline	ACLOTH	350cm 11.5 ft	25g 0.9 oz	Polyester cord, neoprene pouch	
 Pocket Shower	APSHOWER		120g 4.3 oz	70D PU-coated Nylon	

LEAVE NO WASTE

PRODUCT NAME	CODE	DIMENSIONS	WEIGHT	MATERIALS	RRP
 Pocket Trowel Alloy	APTROWEL	24.5 x 6.5 x 3cm 9.7 x 2.6 x 1.2 in	100g 3.5 oz	Hard-anodised alloy blade, anodised alloy shaft	
 Pocket Trowel Nylon 66	ASTOOL	25 x 6.5 x 3cm 9.8 x 2.6 x 1.2 in	87g 3.4 oz	Glass-reinforced Nylon 66	
 Ultra-Sil Outhouse	AOH		50g 2.6 oz	30D Nylon	











GAITERS





EXPLORE THE RANGE

GAITERS					ANKLE GAITERS		ACCESSORIES
 UPDATED	 UPDATED	 UPDATED	 UPDATED	 UPDATED	 UPDATED	 UPDATED	
ALPINE	QUAGMIRE EVENT	QUAGMIRE CANVAS	OVERLAND	GRASSHOPPER	SPINIFEX	TUMBLEWEED	REPLACEMENT STRAPS

EUR	37	38	39	40	41	42	43	44	45	46	47							
BOOT SIZE	UK	4	4.5	5	5.5	6	6.5	7	7.5	8	8.5	9	9.5	10	10.5	11	11.5	12
	US	5	5.5	6	6.5	7	7.5	8	8.5	9	9.5	10	10.5	11	11.5	12	12.5	13
GAITER SIZE		SMALL			MEDIUM			LARGE			X-LARGE							



GAITERS

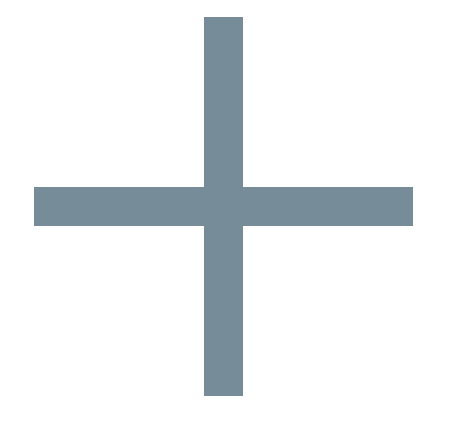

OUR GAITERS FEATURE:

FRONT OPENING

Hook-and loop adjustable front opening gives fantastic fit, easy access and shin protection.

LACE HOOK

Made with 316 grade stainless steel.

REPLACEABLE STRAP/CORD

Removable and replaceable underfoot strap or cord secures the gaiter around the instep.

PFC-FREE

All fabrics use a C0 DWR which is PFC-free.



ALPINE GAITERS

Trimmed down for speed and lightweight appeal.

SIZES S / M / L / XL



QUAGMIRE EVENT® GAITERS

Breathable eVent® panels and shin-protecting front opening—the perfect all-season backcountry gaiter.

SIZES S / M / L / XL





**QUAGMIRE
CANVAS** GAITERS

Robust, comfortable and reliable lower leg protection in even the harshest environments.

SIZES S / M / L / XL



OVERLAND
GAITERS

Overland gaiters are perfect for their namesake Tasmanian track and adventures beyond.

SIZES S / M / L / XL



GRASSHOPPER
GAITERS

Our Grasshopper Gaiter is a straightforward, great value-for-money choice that are robust, easy to put on and easily adjusted.

SIZES S/M L/XL



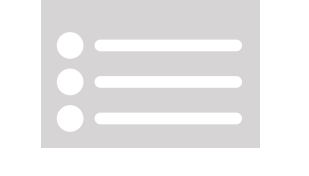

SPINIFEX ANKLE GAITERS

This heavy-duty, minimalist gaiter will guard your socks and ankles from stones, sticks, seeds and sand.

FEATURES

- Available in 450D Polyester or 8oz Canvas

SIZES One Size



TUMBLEWEED ANKLE GAITERS

The Tumbleweed is designed for use with adventure sport shoes to keep mud, sand, stones and seeds out. Regardless of whether you're running Tasmania's Overland Track in a day, mowing the lawn or spreading mulch in the garden, these gaiters are perfect.

SIZES S/M L/XL



GAITER STRAPS REPLACEMENT PAIR

Our replacement gaiter straps are made of super hard-wearing, pressure injected, high density webbing.





KNEE GAITERS

PRODUCT NAME	CODE	SIZE	TO FIT BOOT SIZE	WEIGHT	MATERIALS	RRP
Alpine Gaiters	ACP012042-040101	Small	37-40	250g 8.8 oz	Upper: eVent® fabric Lower: 1000D Nylon	
	ACP012042-050102	Medium	39-42	265g 9.3 oz		
	ACP012042-060103	Large	41-45	280g 9.9 oz		
	ACP012042-070104	XL	43-47	295g 10.4 oz		
Quagmire eVent® Gaiters	ACP012052-040101	Small	37-40	300g 10.6 oz	Upper: eVent® fabric Lower: 1000D Nylon	
	ACP012052-050102	Medium	39-42	325g 11.5 oz		
	ACP012052-060103	Large	41-45	345g 12.2 oz		
	ACP012052-070104	XL	43-47	360g 12.7 oz		
Quagmire Canvas Gaiters	ACP012012-040101	Small	37-40	310g 10.9 oz	Upper: 8oz Canvas Lower: 1000D Nylon	
	ACP012012-050102	Medium	39-42	330g 11.6 oz		
	ACP012012-060103	Large	41-45	350g 12.3 oz		
	ACP012012-070104	XL	43-47	370g 13.1 oz		
Overland Gaiters	ACP012022-040101	Small	37-40	210g 7.4 oz	Upper: 450D polyester Lower: 1000D Nylon	
	ACP012022-050102	Medium	39-42	225g 7.9 oz		
	ACP012022-060103	Large	41-45	240g 8.5 oz		
	ACP012022-070104	XL	43-47	260g 9.2 oz		
Grasshopper Gaiters	ACP012032-040101	S/M	37-42	185g 6.5 oz	450D polyester	
	ACP012032-060102	L/XL	41-47	205g 7.2 oz		



ANKLE GAITERS

PRODUCT NAME	CODE	SIZE	TO FIT BOOT SIZE	WEIGHT	MATERIALS	RRP
Spinifex Ankle Gaiters	CANVAS	ACP011022-130101	One Size	One Size	170g 6 oz	8oz canvas
	POLYESTER	ACP011012-130101			150g 5.3 oz	450D Polyester
Tumbleweed Ankle Gaiters	ACP011022-040101	S/M	37-42	110g 3.9 oz	228T Taslan Nylon	
	ACP011022-060102	L/XL	41-47	120g 4.2 oz		

GAITER ACCESSORIES

PRODUCT NAME	CODE	DIMENSIONS	WEIGHT	MATERIALS	RRP
Gaiter Straps Replacement Pair	AGSR	38 x 1.5 x 0.3cm 15 x 0.6 x 0.1 in	394g 2 oz	Pressure-injected Polyester webbing	



INSECT PROTECTION CLOTHING





EXPLORE THE RANGE

HEAD NETS



MOSQUITO HEADNET



NANO
MOSQUITO HEADNET



ULTRA-MESH
MOSQUITO HEADNET

BUG WEAR



BUG JACKET + PANTS



HEAD NETS



OUR HEAD NETS FEATURE:

MAXIMUM VISIBILITY

Black mesh offers better visibility than white mesh.

COMFORTABLE

Made with soft fibres.

EASY TO USE

Elasticised neck drawcord closure.

HANDY STORAGE

Packaged in a handy stuff sack or pouch.



HEAD NET

When the bugs are thick, wearing a head net is the answer.

FEATURES

- Fine woven 80 hole/cm² hexagonal mesh
- Wide enough to wear with a hat or without



15D ULTRA-MESH™



ULTRA-MESH HEAD NET

Keep even the smallest insects at bay—including no-see-ums, sand-flies and midges.

FEATURES

- Ultra-fine 310 hole/cm² (2000 holes/in²) hexagonal mesh



15D ULTRA-VIS™



NANO HEAD NET

No one wants bugs on their face—this tiny head net is the answer.

FEATURES

- 15D Ultra-Vis 80 hole/cm² hexagonal mesh
- Lightest and smallest insect head net available





BUG WEAR

Our bug clothing uses no-see-um mesh to provide superior bug protection for any outdoor activity, no matter how small your assailant might be.

BUG JACKET & MITTS

- YKK zippered hood for easy head access
- Adjustable cuffs

BUG PANTS & SOCKS

- Adjustable cuffs and waist
- Generous sizing designed to fit over clothing

SIZES S / M / L / XL







HEAD NETS

PRODUCT NAME	CODE	WEIGHT	MATERIALS	COLOUR	RRP
Head Net	AMOSH	30g 1.3 oz	50D Polyester Mesh	●	
Head Net - Permethrin Treated	AMOSHP				
 Nano Head Net	ANMOSH	11g 0.4 oz	15D Nylon Mesh	●	
Nano Head Net - Permethrin Treated	ANMOSHP				
Ultra-Mesh Head Net	AUMOSH	23g 0.8 oz	15D Nylon Mesh	●	

BUG WEAR

PRODUCT NAME	CODE	SIZE	WAIST SIZE	CHEST SIZE	MATERIALS	RRP
 Bug Jacket & Mitts	ABUGJMS	S		34-36 in	Polyester no-see-um mesh	
	ABUGJMM	M		38-40 in		
	ABUGJML	L		42-44 in		
	ABUGJMXL	XL		46-48 in		
 Bug Pants & Socks	ABUGPSS	S	36-39 in		Polyester no-see-um mesh	
	ABUGPSM	M	32-34 in			
	ABUGPSL	L	28-30 in			
	ABUGPSXL	XL	42-44 in			

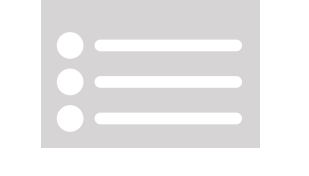

INSECT PROTECTION SHELTERS





INSECT PROTECTION SHELTERS

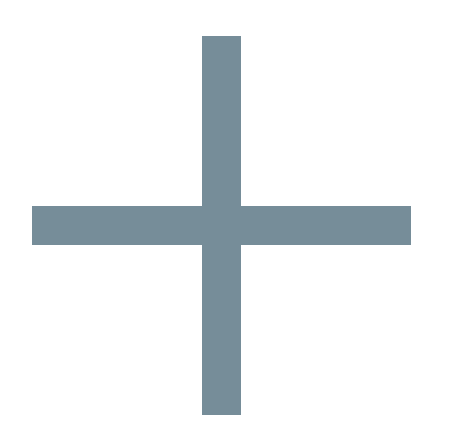

OUR INSECT PROTECTION SHELTERS FEATURE:

MAXIMUM VISIBILITY

Black mesh offers better visibility than white mesh.

MOSQUITO PROTECTION

Minimum 80 holes/cm² = far finer than WHO recommendations for mosquito protection.

EASY SET UP

colour coded corners for easy setup and elasticised hanging cord minimises snagging and aids in height adjustment.

PRACTICAL

Asymmetrical hanging point gives practical headroom, while elasticised hem secures net under mat for extra protection.

HANDY STORAGE

Individual stuff sacks to help keep your gear organised.



Permethrin

Treated Mosquito Nets



NANO™ MOSQUITO PYRAMID NET

Ultra-lightweight and compact protection from mosquitoes and other bugs.

SIZES Single / Double



80 HOLES per cm

15D ULTRA-VIS™



MOSQUITO PYRAMID NET

Protect your sleeping self from pesky bugs—they might see you, but they can't get to you.

SIZES Single / Double



80 HOLES per cm





INSECT PROTECTION SHELTERS

PRODUCT NAME	CODE	SIZE	DIMENSIONS	WEIGHT	MATERIALS	RRP
Nano Mosquito Pyramid Net	ANMOSD	Double	240 x 170 x 130cm 94.5 x 66.9 x 51.2 in	137g 4.8 oz	15D mono-filament Nylon	
	ANMOSS	Single	221 x 122 x 107cm 87 x 48 x 42.1 in	82g 2.9 oz		
Mosquito Pyramid Net	AMOSS	Single	221 x 122 x 107cm 87 x 48 x 42.1 in	240g 8.5 oz	50D multi-filament polyester	
	AMOSD	Double	240 x 170 x 130cm 94.5 x 66.9 x 51.2 in	340g 12 oz		
Mosquito Pyramid Net - Permethrin Treated	AMOSSP	Single	221 x 122 x 107cm 87 x 48 x 42.1 in	245g 8.6 oz	50D multi-filament polyester	
	AMOSDP	Double	240 x 170 x 130cm 94.5 x 66.9 x 51.2 in	350g 12.3 oz		



PACK + RAIN PROTECTION





EXPLORE THE RANGE

PACK COVERS



Ultra-Sil
PACK COVER



NYLON
PACK COVER

PACK LINERS



Ultra-Sil
PACK LINER



WATERPROOF
PACK LINER 70D

PONCHOS



Ultra-Sil NANO
PONCHO



Ultra-Sil NANO
TARP PONCHO



NYLON
TARP PONCHO



Ultra-Sil PACK COVER

A super-lightweight pack cover you can trust.

FEATURES

- No-seam construction for water resistance
- Keeper strap (sizes S-L) pulls the pack cover tight across the pack harness

SIZES XXS / XS / S / M / L

COLOURS  

30D ULTRA-SIL™



NYLON PACK COVER

Give your gear an extra layer of protection from the elements with our durable and lightweight pack cover.

FEATURES

- Drawcord design holds the cover securely in place around the backpack
- Packs away in its own stuff sack when not in use

SIZES XS / S / M / L

COLOURS   

70D WATERPROOF FABRIC





30D ULTRA-SIL™



Ultra-Sil PACK LINER

The security of keeping gear dry inside your pack without loading it down.

FEATURES

- Opens wide for easy packing when it's inside a pack
- Unique top closure: extra fabric at the top folds in and fastens in place, then rolls down, creating a more compact closed loop at the top

SIZES S / M / L

COLOURS   



70D WATERPROOF FABRIC



WATERPROOF PACK LINER 70D

Protect your pack contents with our waterproof liner that provides peace of mind, no matter what the elements might throw at you.

FEATURES

- Unique top closure: extra fabric at the top folds in and fastens in place, then rolls down, creating a more compact closed loop at the top
- Polyurethane coating with white pigment for greater interior visibility

SIZES S / M / L

COLOURS   





15D ULTRA-SIL™



Ultra-Sil NANO PONCHO

Compact and super-lightweight rain protection—for hiking or the football.

FEATURES

- Press studs offer the alternative of closing sides when in use

COLOURS ● ●

70D WATERPROOF FABRIC



NYLON TARP PONCHO

Two-in-one versatility for rain protection on the trail.

FEATURES

- Accommodates a large backpack
- Easily converts from rainwear to a two-person shelter
- Double stitched, tape sealed, three-panel hood

COLOURS ● ●



Ultra-Sil NANO TARP PONCHO

Our Ultra-Sil Nano Tarp Poncho is a raincoat, pack cover, groundsheet and tarp all in one. An ideal solution in temperate climates and can be used as an emergency shelter if needed.

FEATURES





- Siliconised outer surface won't wet out

COLOURS ● ●





PACK COVERS

PRODUCT NAME	CODE	SIZE	FITS PACK SIZE	DIMENSIONS	WEIGHT	MATERIALS	COLOUR	RRP
 Ultra-Sil Pack Cover	APCSILXXS	XXS	10-15L	54 x 18 x 18cm 21.3 x 7.1 x 7.1 in	43g 1.5 oz	30D PU-coated, siliconised CORDURA® Nylon		
	APCSILXS	XS	15-30L	66 x 26 x 25cm 26 x 10.2 x 9.8 in	57g 2 oz			
	APCSILS	Small	30-50L	62 x 40 x 20cm 24.4 x 15.8 x 7.9 in	85g 3 oz			
	APCSILM	Medium	50-70L	78 x 35 x 30cm 30.7 x 13.8 x 11.8 in	113g 4 oz			
	APCSILL	Large	70-95L	94 x 43 x 35.5cm 37 x 16.9 x 14 in	130g 4.6 oz			
 Nylon Pack Cover	APCXs	XS	20-30L	66 x 26 x 25cm 26 x 10.2 x 9.8 in	99g 3.5 oz	70D PU-coated Nylon		
	APCS	Small	30-50L	80 x 30 x 27cm 31.5 x 11.8 x 10.6 in	111g 3.9 oz			
	APCM	Medium	50-70L	78 x 35 x 30cm 30.7 x 13.8 x 11.8 in	139g 4.9 oz			
	APCL	Large	70-95L	94 x 43 x 35.5cm 37 x 16.9 x 14 in	172g 6.1 oz			



PACK LINERS

PRODUCT NAME	CODE	SIZE	FITS PACK SIZE	DIMENSIONS	WEIGHT		COLOUR	RRP
Ultra-Sil Pack Liner	APLUS	Small	<50L	83.5 x 29 x 28cm 32.9 x 11.4 x 11 in	74g 2.6oz	30D PU-coated, siliconised CORDURA® Nylon		
	APLUM	Medium	<70L	97.5 x 32 x 30cm 38.4 x 12.6 x 11.8 in	98g 3.5oz			
	APLUL	Large	<90L	129.5 x 34 x 33cm 51 x 13 x 13.4 in	126g 4.4oz			
Waterproof Pack Liner 70D	APLS	Small	<50L	83.5 x 29 x 28cm 32.9 x 11.4 x 11 in	232g 8.2 oz	70D PU-coated Nylon		
	APLM	Medium	<70L	97.5 x 32 x 30cm 38.4 x 12.6 x 11.8 in	272g 9.6 oz			
	APLL	Large	<90L	129.5 x 34 x 33cm 51 x 13 x 13.4 in	374g 13.2 oz			

PONCHOS

PRODUCT NAME	CODE	DIMENSIONS	WEIGHT	MATERIALS	COLOUR	RRP
Ultra-Sil Nano Poncho	APONSTD15D	140 x 118cm 55.1 x 46.5 in	150g 5.3oz	30D PU-coated, siliconised CORDURA® Nylon		
Ultra-Sil Nano Tarp Poncho	APONCHO15D	265 x 145cm 104.3 x 57.1 in	230g 9oz			
Nylon Tarp Poncho	APONCHO	253 x 137cm 99.6 x 53.9 in	408g 14.4oz	70D PU-coated Nylon		

TRAVEL + COMMUTE



EVERY DAY CARRY

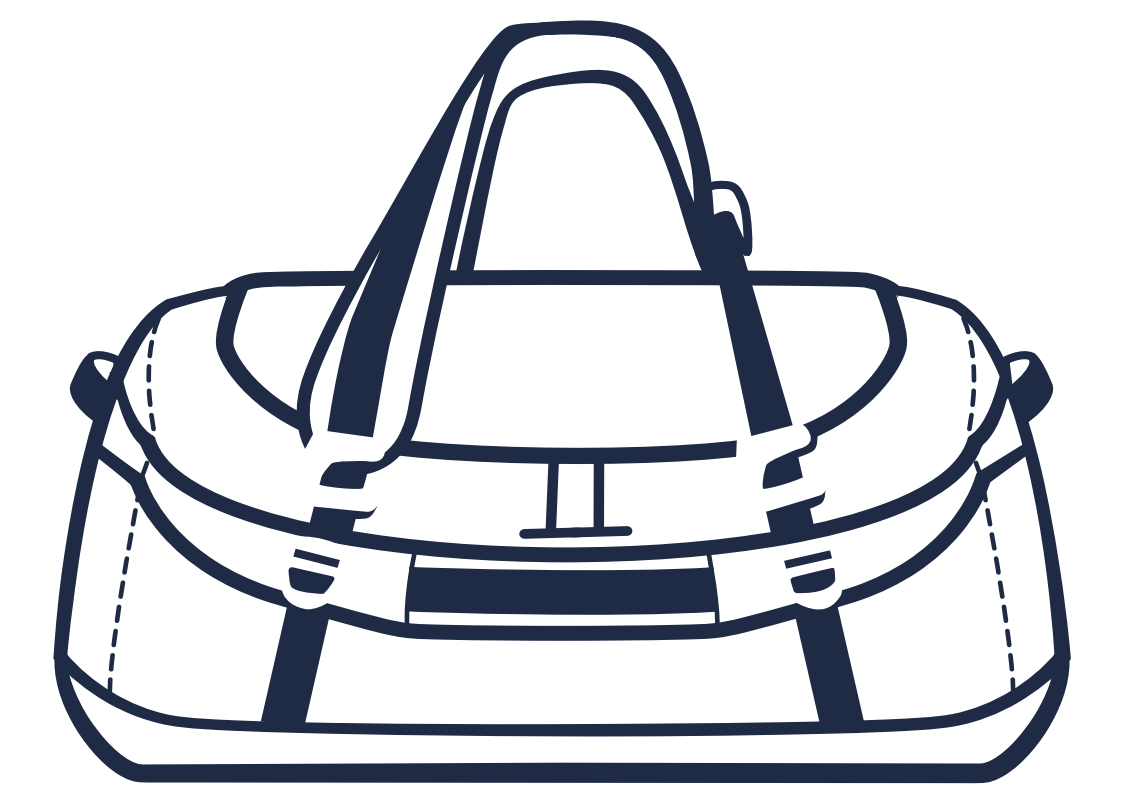

BAGS + LUGGAGE



ORGANISATION

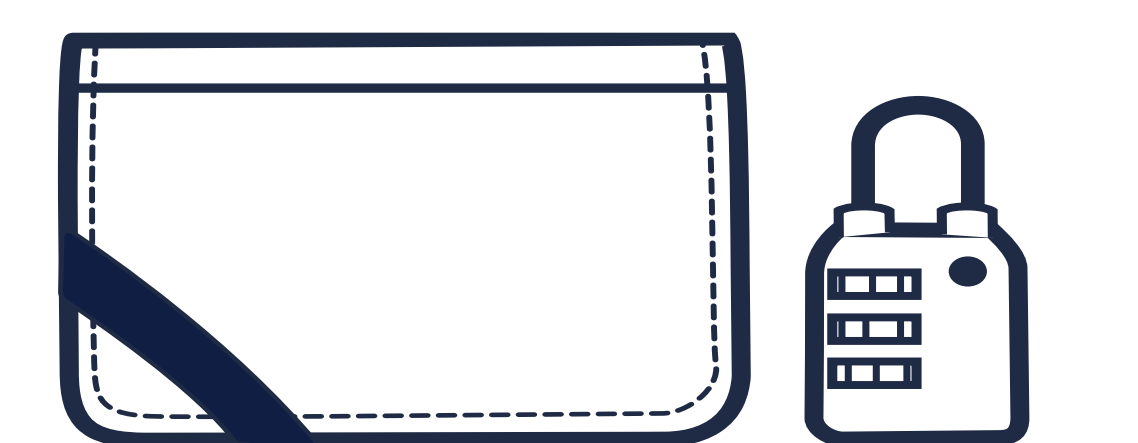

TRAVEL ACCESSORIES



EVERY DAY CARRY











This range might have been inspired by adventures to fiery mountains or golden sands, but it's equally comfortable with any everyday challenge.

Conquer bike commuting in the rain, be prepared for that unexpected shopping purchase or ditch the luggage for an impromptu day trip dalliance in a foreign land. Whatever you're faced with, we're up to the task.





EXPLORE THE RANGE

BACKPACKS	PACKABLE BAGS		UMBRELLAS
 <p data-bbox="259 990 643 1018">RAPID 26 LITRE DRYPACK</p>	<p data-bbox="926 442 1052 470">NANO</p>  <p data-bbox="886 977 1126 1037">Ultra-Sil NANO DAYPACK</p>	<p data-bbox="1775 442 2052 470">LIGHTWEIGHT</p>  <p data-bbox="1552 977 1745 1037">Ultra-Sil DUFFLE BAG</p>  <p data-bbox="2079 977 2312 1037">Ultra-Sil SHOPPING BAG</p>	 <p data-bbox="2702 977 3042 1037">Ultra-Sil TREKKING UMBRELLA</p>
 <p data-bbox="259 1577 643 1605">FLOW 35 LITRE DRYPACK</p>	 <p data-bbox="839 1558 1169 1618">Ultra-Sil NANO SHOPPING BAG</p>	 <p data-bbox="1579 1558 1719 1618">Ultra-Sil DAYPACK</p>  <p data-bbox="2089 1558 2302 1618">Ultra-Sil DRY DAYPACK</p>	 <p data-bbox="2718 1577 3025 1605">POCKET UMBRELLA</p>



BACKPACKS

High performance waterproof daypacks for all your outdoor adventures



OUR BACKPACKS

FEATURE:

EASY ACCESS

Top-loading roll-top main chamber.

WATERPROOF

Fully seam sealed construction.

CONVENIENT

Internal zippered pocket for small items and stretch mesh side pockets.

FUNCTIONAL

White interior to make it easier to view contents.

420D WATERPROOF FABRIC



RAPID 26 LITRE DRYPACK

The perfect streamlined all-weather commuting pack.

FEATURES

- Simple webbing waist strap keeps the pack secure and in place
- Water-resistant external pocket for easy access to small items

COLOURS

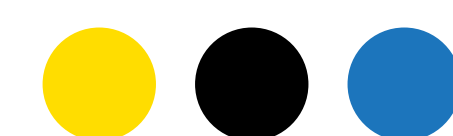

FLOW 35 LITRE DRYPACK

Dry Backpack—perfected.

FEATURES

- Substantial waist belt helps support heavier loads in comfort.
- Side straps with hook-release buckles for compression when the pack isn't full
- Tough tabs on rear of pack for bungee/accessory cord attachment to increase available storage

COLOURS

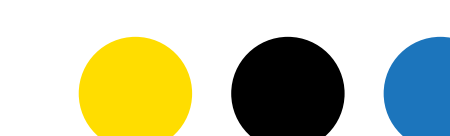



PACKABLE BAGS

The bag to take when you're not taking a bag...

We know lightweight better than anyone, and we've stripped our packable bags down to the bare minimum, all without compromising on strength and performance.



OUR PACKABLE BAGS FEATURE:

SMALL

Exceptionally compact packable design.

EASY TO USE

Siliconised Nylon fabric for easy packing and water resistance.

STRONG AND DURABLE

Bar-tacked and reinforced stitching at key stress points.

SUPER COMPACT

Packs into an attached Ultra-Sil stuff sack.



NANO PACKABLE BAGS | 15D ULTRA-SIL™



Ultra-Sil NANO DAYPACK

Our lightweight, compact Nano Daypack is the ultimate summit and travel pack. Half the weight and pack size of our award-winning Ultra-Sil Daypack, it's easily stashed in your pocket or on your keyring as the perfect travel companion.

FEATURES

- Asymmetrical zipper design for tiny packed size
- Weighs just 30g, can carry up to 20kg

COLOURS

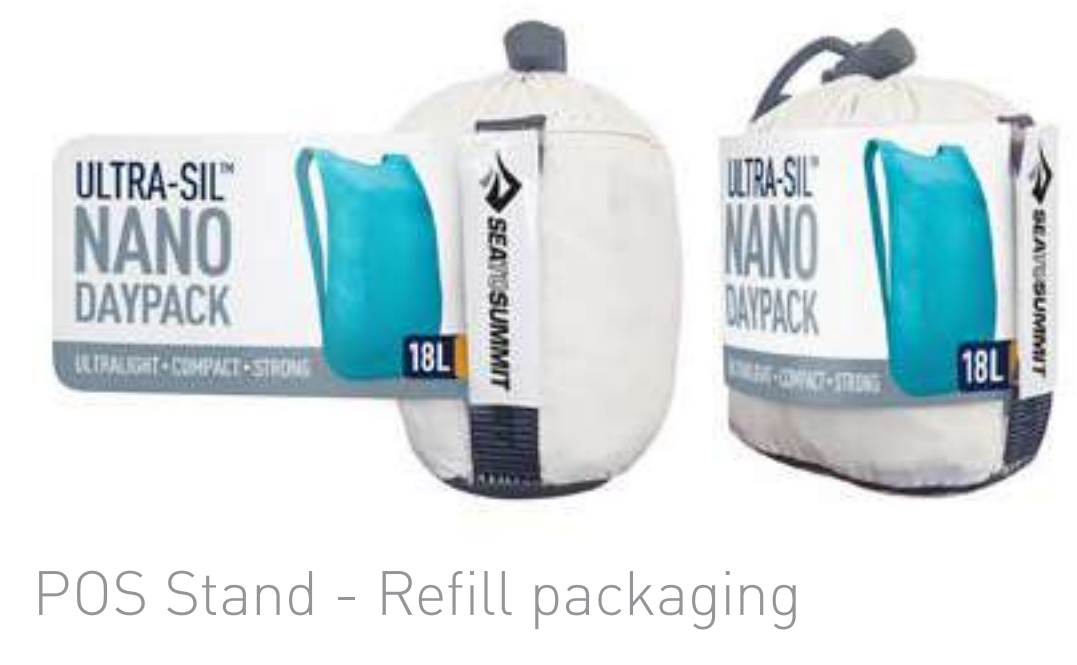
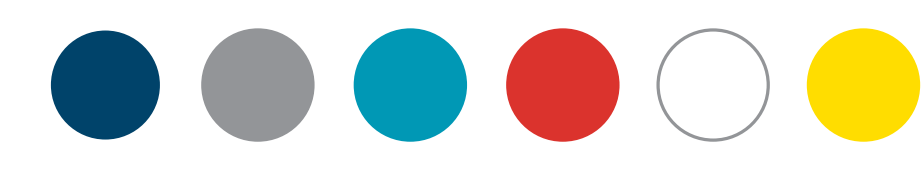

POS Stand - Refill packaging



Ultra-Sil NANO SHOPPING BAG

Our 30g egg-sized Ultra-Sil Nano Shopping Bag is our most compact and reusable alternative to disposable shopping bags.

FEATURES

- 25L carrying capacity
- Large carry handles can be slung over your shoulder or comfortably held in your hand

COLOURS

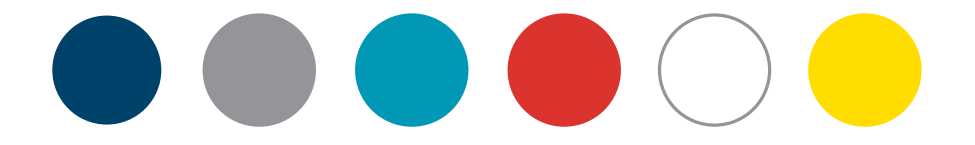

POS Stand - Refill packaging





LIGHTWEIGHT PACKABLE BAGS

30D ULTRA-SIL™



Ultra-Sil DUFFLE BAG

Our Ultra-Sil Duffel Bags, the lightest of lightweight duffles.

FEATURES

- 40 litre capacity and strong enough to carry a heavy load

COLOURS

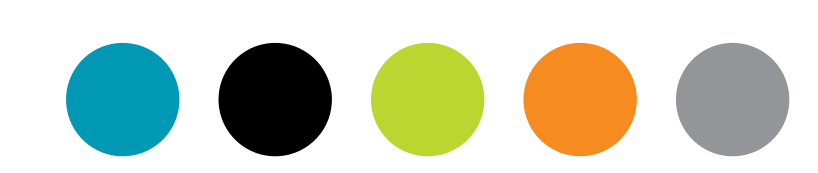

Ultra-Sil SHOPPING BAG

Our reusable Ultra-Sil Shopping Bag can comfortably carry 12 bottles of wine.

COLOURS





LIGHTWEIGHT PACKABLE BAGS

30 D ULTRA-SIL™



Ultra-Sil DAY PACK

Our award-winning Ultra-Sil Day Pack is a minimalist must-have that provides surprising versatility and performance for such a small package. With a handy 20 litre capacity, it is equally at home as a summit pack on hiking adventures, as a sightseeing day pack while travelling, or for carrying an impromptu grocery shop while on foot or two wheels.

COLOURS



Ultra-Sil DRY DAY PACK

An ultralight daypack that is waterproof and that stows away in its own tiny stuff sack.

FEATURES

- 22 litre capacity
- Elasticised compression lacing system

COLOURS





UMBRELLAS



Ultra-Sil TREKKING UMBRELLA

Keep dry and shaded on the trail with this compact and lightweight umbrella.

FEATURES

- Large canopy size of 96cm
- UPF 50+ sun protection

COLOURS



TravellingLight POCKET UMBRELLA

Be prepared and keep dry with this lightweight and compact mini umbrella.

FEATURES



- Canopy diameter 83cm

COLOURS









DRYPACKS

PRODUCT NAME	CODE	DIMENSIONS	WEIGHT	COLOUR	RRP
 Flow 35 Litre DryPack	AWDP35	64 x 28 x 15cm 22 x 17 x 6.5 in	1210g 42.7 oz		
Rapid 26 Litre DryPack	AWDP26	60 x 30 x 15cm 23.6 x 11.8 x 5.9 in	880g 31 oz		

NANO PACKABLE BAGS

PRODUCT NAME	CODE	SIZE	WEIGHT	COLOUR	RRP
 Ultra-Sil Nano Daypack	A15DP	Single	30g 1.1 oz		
	A15DP4P	Pack of 4 (refill)			
	DISPA15D12	12 Piece Loaded Display			
	DISPA15DP24	24 Piece Loaded Display			
 Ultra-Sil Nano Shopping Bag	A15SB	Single	30g 1.1 oz		
	A15SB4P	Pack of 4 (refill)			
	DISPA15SB12	12 Piece Loaded Display			
	DISPA15SB24	24 Piece Loaded Display			



LIGHTWEIGHT PACKABLE BAGS

PRODUCT NAME	CODE	VOLUME	WEIGHT	COLOUR	RRP
Ultra-Sil Duffle Bag	AUDUF	40L	80g 3.2oz		
Ultra-Sil Shopping Bag	AUSBAG	25L	46g 1.6oz		
Ultra-Sil Day Pack	AUDP	20L	72g 2.5oz		
Ultra-Sil Dry Day Pack	AUDDP	22L	110g 3.9oz		

UMBRELLAS

PRODUCT NAME	CODE	DIMENSIONS	COLLAPSED DIMENSIONS	WEIGHT	MATERIALS	COLOUR	RRP
Ultra-Sil Trekking Umbrella	AUMBBK	ø98 x 58cm ø38.6 x 22.8 in	ø5.7 x 24cm ø2.2 x 9.4 in	280g 12 oz	CORDURA® Nylon canopy with a water-shedding DWR		
TravellingLight Pocket Umbrella	AUMBMINI	ø84 x 52cm ø33.1 x 20.5 in	ø4 x 18.5cm ø1.6 x 7.3 in	150g 6.5 oz			



BAGS + LUGGAGE





DUFFLE BAG

The Sea to Summit Duffel is a fully featured expedition duffel for hauling gear. It was designed to be more versatile, easier to use and more comfortable to carry than any other duffel at base camp.

FEATURES

- Large lid for easy packing and fast access to gear
- Multi-functional handles provide three versatile carry options
- Dual-zipper is super durable and anti-theft
- High strength hooks allow quick change of handle position



SIZES 45L / 65L / 90L / 130L

COLOURS   





DUFFLE BAGS

PRODUCT NAME	CODE	SIZE	DIMENSIONS	WEIGHT	MATERIALS	COLOUR	RRP
 Duffle Bag	ADUF45	45L	58 x 29 x 29cm 22.8 x 11.4 x 11.4 in	1650g 58.2 oz	Waterproof tarpaulin laminate, 1000D Nylon base, YKK double #10 zipper		
	ADUF65	65L	66 x 33 x 33cm 26 x 13 x 13 in	1750g 61.7 oz			
	ADUF90	90L	74 x 37 x 37cm 29.1 x 14.6 x 14.6 in	2050g 72.3 oz			
	ADUF130	130L	84 x 42 x 42cm 33.1 x 16.5 x 16.5 in	2450g 86.4 oz			



ORGANISATION





EXPLORE THE RANGE

PACKING ORGANISATION

TOILETRY CASES



GARMENT MESH BAG



PACKING CELL



SHOE BAG



LAUNDRY BAG



SHIRT FOLDER



DOCUMENT POUCH



NEOPRENE ZIP POUCH



HANGING TOILETRY BAG



TOILETRY BAG



SEE POUCH



CLEAR ZIPTOP POUCH



PACKING SOLUTIONS

Whether your idea of travel is by plane, boat or car our range of travel accessories will help you organise and separate your clothes, shoes, toiletries and documents without taking up precious luggage space or adding weight.

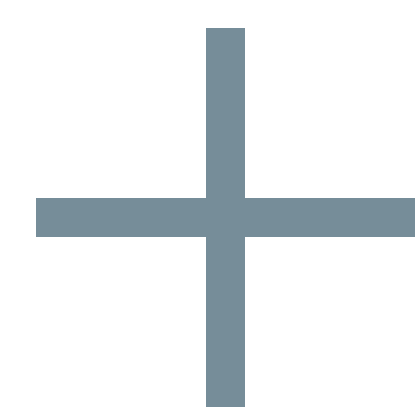

OUR PACKING ORGANISATION RANGE FEATURES:

ULTRA-SIL FABRIC

Great for travel as it's water resistant.

DURABLE ZIPS

with strong grab tags for easy, secure opening and closing.

INTERNAL POCKETS

3D SHAPES

Fit the contours of modern luggage.



TravellingLight GARMET MESH BAG

Organise your garments, organise your travelling life.

FEATURES

- Ultra-lightweight, packs flat when empty

SIZES S / M / L

COLOURS





TravellingLight **PACKING CELL**

Organised packing and unpacking made easy.

SIZES S / M / L

COLOURS



TravellingLight **SHOE BAG**

Prevent dirty shoes from touching your clean clothes.

FEATURES

- Large: holds two pairs of regular sized shoes or a pair of boots
- Small: fits a pair of regular sized shoes or low boots

SIZES S / L

COLOURS



TravellingLight **LAUNDRY BAG**

Keep your dirty laundry separate and contained.

FEATURES

- Mesh front and back panels for breathability

COLOURS





TravellingLight SHIRT FOLDER

Keep your shirts and pants wrinkle-free and easily accessible.

SIZES S / L

COLOURS



TravellingLight DOCUMENT POUCH - A4

Keep all your documents safe, secure and organised with the TravellingLight Document Pouch.

FEATURES

- Organises and protects documents, featuring two zippered pockets

COLOURS



TravellingLight PADDED POUCH

Our Padded Pouch protects your fragile travel items—perfect for compact cameras, audio players and other electronics.

SIZES S / M / L

COLOURS





PACKING ORGANISATION

PRODUCT NAME	CODE	SIZE	DIMENSIONS	WEIGHT	MATERIALS	COLOUR	RRP
TravellingLight Garment Mesh Bag	ATLGMBL	Small	25 x 19 x 9cm 9.8 x 7.5 x 3.5 in	60g 2.1 oz			
	ATLGMBM	Medium	35 x 25 x 9cm 13.8 x 9.8 x 3.5 in	86g 3 oz			
	ATLGMBL	Large	40 x 30 x 9cm 15.8 x 11.8 x 3.5 in	110g 3.9 oz			
TravellingLight Packing Cell	ATLPCS	Small	19.5 x 13.5 x 11cm 7.7 x 5.3 x 4.3 in	44g 1.6 oz	30D Siliconised CORDURA®, mesh		
	ATLPCM	Medium	21 x 19.5 x 16cm 8.3 x 7.7 x 6.3 in	56g 2 oz			
	ATLPCL	Large	30 x 20 x 19.5cm 11.8 x 7.9 x 7.7 in	66g 2.3 oz			
TravellingLight Shoe Bag	ATLSBS	Small	29.5 x 13.5 x 12cm 11.6 x 5.3 x 4.7 in	62g 2.2 oz			
	ATLSBL	Large	34 x 19 x 15cm 13.4 x 7.5 x 5.9 in	84g 3 oz			
TravellingLight Laundry Bag	ATLLB			68g 2.4 oz			
TravellingLight Shirt Folder	ATLSFS	Small	39 x 24.5 x 8cm 15.4 x 9.7 x 3.2 in	248g 8.7 oz	30D siliconised CORDURA®		
	ATLSFL	Large	44 x 30 x 10cm 17.3 x 11.8 x 3.9 in	338g 11.9 oz			
Document Pouch - A4	ATLDPA4LBK	Fits A4	297 x 210 x cm 0 x 0 x 0 in	85g 3 oz			
TravellingLight Zip Pouch	ATLPPS	Small	16.5 x 14 x 2cm 6.5 x 5.5 x 0.8 in	30g 1.1 oz	Neoprene		
	ATLPPM	Medium	18.5 x 15.5 x 2cm 7.3 x 6.1 x 0.8 in	37g 1.3 oz			
	ATLPPL	Large	20 x 19.5 x 2cm 7.9 x 7.6 x 0.8 in	49g 1.7 oz			



TOILETRY CASES

Ultra-lightweight and water resistant Ultra-Sil fabric keeps toiletry spills contained while internal zippered mesh pockets ensure that you stay organised—all without adding bulk.

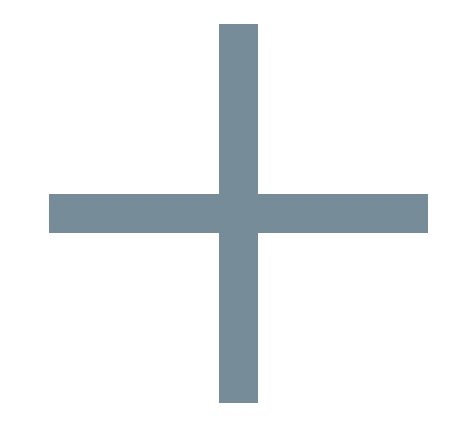

OUR TOILETRY CASE RANGE FEATURES:

ULTRA-SIL

Great for travel as it's water resistant.

DURABLE ZIPS

with strong grab tags for easy, secure opening and closing.

INTERNAL POCKETS

and dividers for organisation.

3D SHAPES

Fit the contours of modern luggage.



TravellingLight HANGING TOILETRY BAG

Hangs in your bathroom, on a tree branch or off your wing mirror for ease of access.

FEATURES

- Shatterproof detachable mirror included

SIZES

S / L

COLOURS





TravellingLight TOILETRY BAG

Your ultralight and minimalist toiletry solution.

FEATURES

- External zippered pocket and internal mesh pocket for organisation

SIZES S / L

COLOURS



TravellingLight SEE POUCH

Visual organisation of small, loose items made simple.

FEATURES

- Transparent TPU front panel
- Stand up design when full; packs flat for storage

SIZES S / M / L

COLOURS



TravellingLight TPU CLEAR ZIPTOP POUCH KIT

TSA-friendly clear zip top pouch with leak-proof reusable bottles.

FEATURES

- Welded construction with leak-resistant zipper
- Includes 3 x 100mL and 3 x 50mL Sea to Summit leak-proof bottles

COLOURS





TOILETRY CASES

PRODUCT NAME	CODE	SIZE	DIMENSIONS	WEIGHT	MATERIALS	COLOUR	RRP
TravellingLight Hanging Toiletry Bag	ATLHTBS	Small	40 x 23 x 6cm 15.8 x 9.1 x 2.4 in	80g 2.8 oz	30D Ultra-Sil		
	ATLHTBL	Large	52 x 25 x 8cm 20.5 x 9.8 x 3.2 in	114g 4 oz			
TravellingLight Toiletry Bag	ATLTBS	Small	21 x 11 x 9.5cm 8.3 x 4.3 x 3.7 in	40g 1.4 oz	30D Ultra-Sil		
	ATLTBL	Large	26 x 13 x 13cm 10.2 x 5.1 x 5.1 in	51g 1.8 oz			
TravellingLight See Pouch	ATLSSPS	Small	20 x 10 x 5cm 8 x 4 x 2 in	27g 1 oz	TPU film, 30D Ultra-Sil		
	ATLSSPM	Medium	25 x 15 x 7.5cm 10 x 6 x 3 in	36g 1.3 oz			
	ATLSSPL	Large	28 x 20 x 7.5cm 11 x 8 x 3 in	40g 1.4 oz			
TravellingLight TPU Clear Ziptop Pouch Kit	ATLTPUCZTP		20 x 11 x 4.5cm 7.9 x 4.3 x 1.8 in	110g 3.9 oz	TPU film, water-resistant zipper, PE bottles		



TRAVEL ACCESSORIES





EXPLORE THE RANGE

TRAVEL SECURITY

TRAVEL COMFORT



RFID TRAVEL WALLETS



TRAVEL WALLETS



TSA TRAVEL LOCKS



EYE SHADE



RFID PROTECTION

A technical range of travel security products protecting against digital theft.



OUR RFID PROTECTION RANGE FEATURES:

RFID TECHNOLOGY

Lined with RFID-proof fabric for digital credit card/passport protection.

SECURE DESIGNS

Keep money, passports and tickets safe and accessible.

COMFORTABLE

Soft 3D mesh for comfort against your skin.

DISCREET

Low profile design to conceal your travel valuables.



TravellingLight TRAVEL WALLET **RFID**

A lightweight, RFID-proof way to keep your travel life sorted.

FEATURES

- Small: Four credit card slots and two separated bank note sleeves
- Medium: Seven credit card slots, two sleeves, pen holder, zippered coin pouch and an external pocket for boarding pass or itinerary—also fits a passport
- Large: Eight credit card slots, two large sleeves, pen holder, zippered coin pouch and an external pocket for boarding

SIZES S / M / L

COLOURS ●



TravellingLight CARD HOLDER **RFID**

Slim-profile card holder for protecting your information from digital skimmers.

FEATURES

- Four internal card sleeves





TravellingLight NECK POUCH **RFID**

Keep your valuables close and your credit cards safe from digital skimmers with RFID-protection.

FEATURES

- Adjustable and comfortable webbing neck strap
- Small: compact passport size featuring two pockets



TravellingLight NECK WALLET **RFID**

RFID proof neck wallet for organisation and security.

FEATURES

- Five pockets
- Soft, comfortable webbing neck strap



TravellingLight MONEY BELT **RFID**

Slim-profile under-garment money belt with RFID protection from digital skimmers.

FEATURES

- Two zippered pockets with multiple compartments
- Extra soft, brushed elastic waist belt





TravellingLight MONEY BELT

Our TravellingLight Money Belt addresses your security needs for carrying money, credit cards and a passport.

FEATURES

- Two zipper pockets with multiple compartments, keep contents safe but accessible

COLOURS

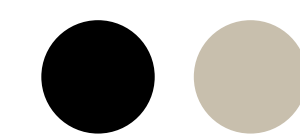

TravellingLight NECK WALLET

Keep your passport, cash and cards secure and close when travelling.

FEATURES

- The versatility of five pockets

COLOURS



TSA APPROVED

TravellingLight TSA TRAVEL LOCKS

All our padlocks are Travel Sentry® approved and feature the red diamond—alerting airport security that they can open this lock without destroying it.

COMBINATION

Compact TSA lock perfect for lockable zip sliders and joining most double-pull zips

COMBO CABLE

Barrel shaped TSA lock with flexible reinforced cable for versatility

CARDKEY

Two credit card and one keyring sized Cardkeys supplied





TRAVEL COMFORT



TravellingLight EYE SHADE

Our TravellingLight Eye Shade is ideal for airplane travel, daytime napping or when you're lucky enough to experience the midnight sun.

FEATURES





- Delicate, contoured microfibre lining for sleeping comfort
- Nose baffle and easy to adjust strap ensure a perfect fit and light-free sleep
- Washable and reusable
- Set of ear plugs included

COLOURS







TRAVEL SECURITY - RFID



PRODUCT NAME	CODE	SIZE	DIMENSIONS	WEIGHT	MATERIALS	COLOUR	RRP
	ATLTWRFIDS	Small	11 x 9 x 2cm 4.3 x 3.5 x 0.8 in	56g 2 oz			
 TravellingLight Travel Wallet RFID	ATLTWRFIDM	Medium	17.5 x 10.5 x 2cm 6.9 x 4.1 x 0.8 in	93g 3.3 oz	30D siliconised CORDURA®, copper-nickel film		
	ATLTWRFIDL	Large	23 x 11 x 2cm 9.1 x 4.3 x 0.8 in	112g 4 oz			
 TravellingLight Card Holder RFID	ATLCHRFID		9.5 x 7 x 0.5cm 3.7 x 2.8 x 0.2 in	14g 0.8 oz	210D Nylon, copper-nickel film		
 TravellingLight Neck Pouch RFID	ATLNPRFIDS	Small	14.5 x 12.5 x 3cm 5.7 x 4.9 x 1.2 in	20g 0.7 oz	30D siliconised CORDURA®, soft 3D mesh, copper-nickel film		
 TravellingLight Money Belt RFID	ATLMBRFID		29 x 13 x 3cm 11.4 x 5.1 x 1.2 in	58g 2.6 oz	30D siliconised CORDURA®, soft 3D mesh, copper-nickel film		
 TravellingLight Neck Wallet RFID	ATLNWRFID		21 x 13.5 x 1.5cm 8.3 x 5.3 x 0.6 in	40g 1.6 oz	30D siliconised CORDURA®, soft 3D mesh, copper-nickel film		



TRAVEL SECURITY

PRODUCT NAME	CODE	TYPE	DIMENSIONS	WEIGHT	MATERIALS	COLOUR	RRP
 TravellingLight Neck Wallet	ATLNW5	5 Pocket	20 x 12.5cm 7.9 x 4.9 in	46g 1.6 oz	210 Nylon, 3D mesh		
	ATLTSACO	Combination TSA lock	5.4 x 2.5 x 1.7cm 2.1 x 1 x 0.7 in	41g 1.4 oz			
 TravellingLight TSA lock	ATLTSACC	Combo Cable TSA lock	8.2 x 3 x 1.7cm 3.2 x 1.2 x 0.7 in	47g 1.6 oz	Zinc alloy, stainless steel cable		
	ATLTSACK	Cardkey TSA lock	7.2 x 4 x 1.7cm 2.8 x 1.6 x 0.7 in	46g 1.6 oz			

TRAVEL COMFORT

PRODUCT NAME	CODE	DIMENSIONS	WEIGHT	MATERIALS	COLOUR	RRP
 TravellingLight Eye Shade	ATLES	19.5 x 8cm 13 x 10 in	23g 0.8 oz	Contoured microfibre lining		

STRAPS + TRANSPORT ACCESSORIES



**ATTACHMENT
ACCESSORIES**



STRAPS

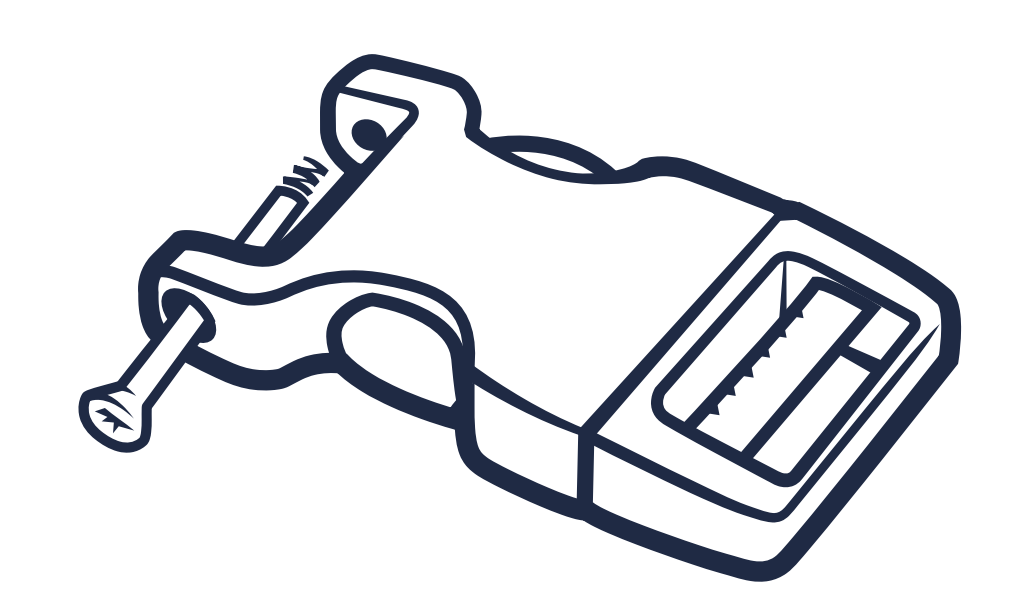

**FIELD REPAIR
ACCESSORIES**

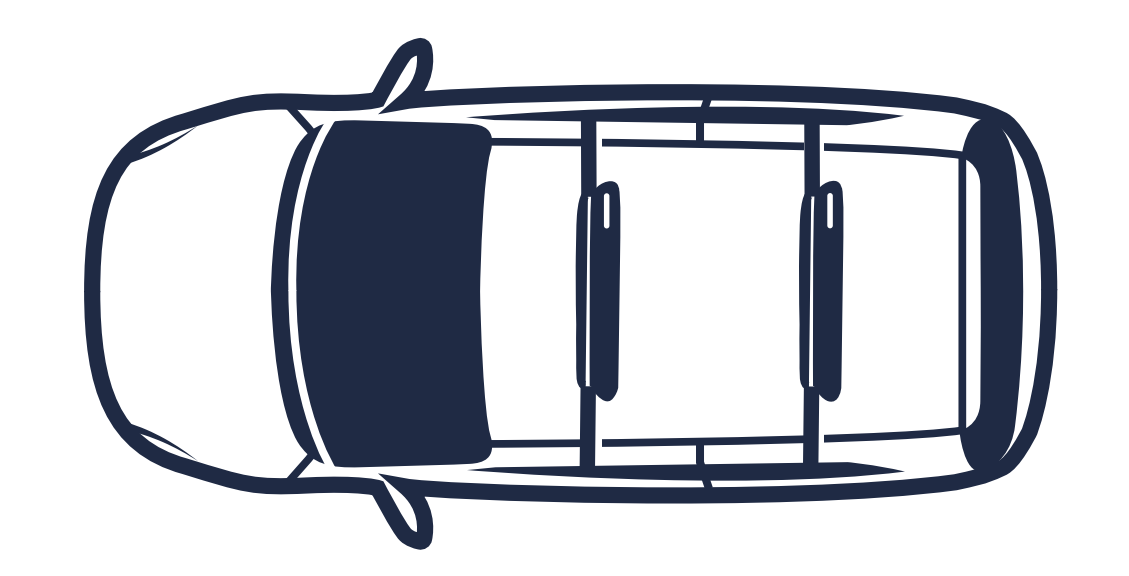

ROOF ACCESSORIES





ATTACHMENT ACCESSORIES



LIGHTWEIGHT + STRONG

Anodised aluminium alloy body, steel wiregate.

QUICKLY SECURE

Easy-to-use spring-steel wiregate design.

STAY ORGANISED

Keep your keys at-hand and secure items in place.

*Non-rated. Not for climbing.



LARGE ACCESSORY CARABINER

FEATURES

- Two-piece Titanium Grey pack or 150-piece multi-colour Counter Top Display unit (Titanium Grey, Atlantic Blue, Burnt Ochre).



SMALL ACCESSORY CARABINER 3-PIECE

FEATURES

- Three-piece pack in three different colours (grey, blue, orange)





CARABINERS

PRODUCT NAME	CODE	SIZE	DIMENSIONS	WEIGHT	MATERIALS	COLOUR	RRP
	ATD0140-00122101	Large	7.5 x 4.5 x 0.6cm 3 x 1.8 x 0.2in	13g 0.5oz			
	ATD0140-00122102	150pce Large Counter Box					
NEW Accessory Carabiner Large	AST011021-121903				anodised aluminium alloy body, spring-steel wiregate		
	AST011021-121604	50pce Refill Bag					
	AST011021-120505						
Accessory Carabiner Small	AABINER3	3pce set	4 x 2.3 x 0.3cm 1.6 x 0.9 x 0.1 in	9g 0.3 oz	anodised aluminium alloy body, spring-steel wiregate		



STRAPS





EXPLORE THE RANGE

TPU STRAPS



STRETCH-LOC

ACCESSORY STRAPS



ACCESSORY STRAPS

TIE-DOWN STRAPS



BOMBER TIE-DOWN



TIE-DOWN
with Silicone Cam Cover



STRETCH-LOC TPU STRAPS

Easy-to-use, strong and versatile straps for securing gear—simply stretch, lock and move on.

FEATURES

- Attach, bundle together or compress most items
- Two or more straps can be joined to increase length
- Keeper Strap provides quick release attachment, extra grip and retains excess strap

WIDTHS 12mm / 20mm

LENGTHS 300mm / 450mm / 375mm / 500mm / 625mm / 750mm

COLOURS   

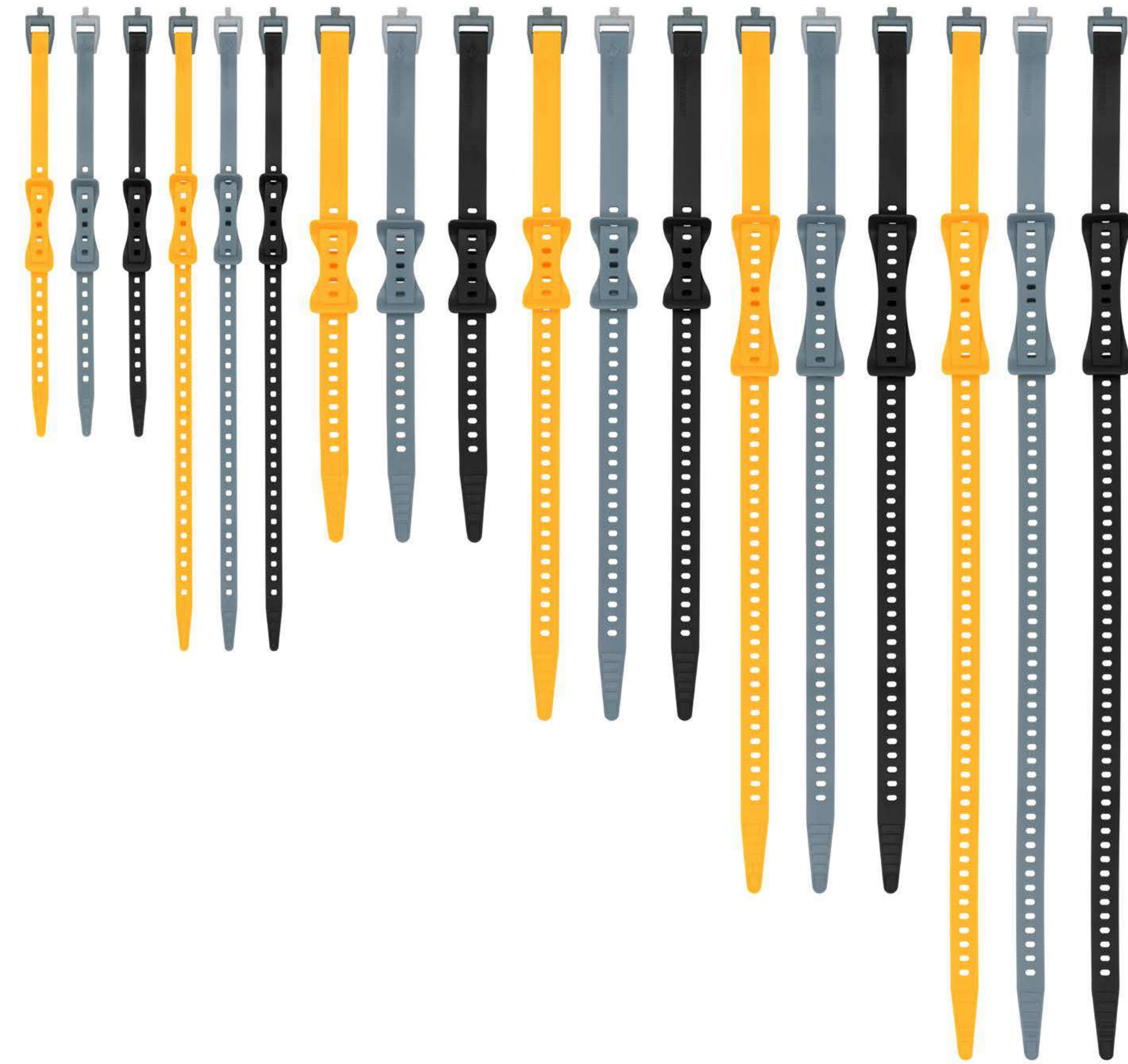

Grippy TPU



Keeper strap retains excess strap



Strong, secure strap with non-slip buckle



Easy and fast to tension and lockup



ACCESSORY STRAPS

Lightweight and versatile straps for lashing gear together or attaching to your pack, deck or bag.

FEATURES

- High load rating
- Comes with either a simple ladder lock, or a quick release hook buckle.

WIDTHS 10mm / 20mm

LENGTHS 1m / 1.5m / 2m

COLOURS   





BOMBER TIE-DOWN

All-purpose tie-down strap with silicone protector pad.

FEATURES

- Integrated elastic strap-keeper for neat storage
- Available in three colour-coded lengths: 2m (lime), 3m (orange) and 4m (blue)

SIZES 2m / 3m / 4m

COLOURS   







TIE-DOWN WITH SILICONE CAM COVER

Hands down the best cam-buckle tie-down you can buy. The silicone cam cover protects your boat or car from the absolutely secure and rugged metal buckle.

FEATURES

- Colour-coded according to size
- Integrated elastic strap-keeper for neat storage

SIZES 3.5m / 4.5m / 5.5m

COLOURS    



















STRETCH-LOC STRAPS

PRODUCT NAME	CODE	SIZE	DIMENSIONS	WEIGHT	MATERIALS	COLOUR	RRP
Stretch-Loc 12 (2 pack)	ASLSTRP12X300	12mm	300mm 11.8 in	15g 0.5 oz (ea)			
Stretch-Loc 17 (2 pack)	ASLSTRP12X450		450mm 17.7 in	18g 0.6 oz (ea)			
Stretch-Loc 15 (2 pack)	ASLSTRP20X375	20mm	375mm 14.8 in	26g 0.9 oz (ea)			
 Stretch-Loc 20 (2 pack)	ASLSTRP20X500		500mm 18.7 in	32g 1.1 oz (ea)	TPU		
Stretch-Loc 25 (2 pack)	ASLSTRP20X625		625mm 24.6 in	39g 1.4 oz (ea)			
Stretch-Loc 30 (2 pack)	ASLSTRP20X750		750mm 29.5 in	45g 1.6 oz (ea)			
Stretch-Loc (4 pack - 20mm, mixed lengths)	ASLSTRP4PCK	20mm	375, 500, 625 & 750mm				











ACCESSORY STRAPS

PRODUCT NAME	CODE	SIZE	BUCKLE TYPE	DIMENSIONS	MATERIALS	COLOUR	RRP
 Alloy Buckle Accessory Strap	ATDAS101.0		Ladderlock	1m 40 in	Polypropylene webbing, anodised aluminium alloy buckles		
	ATDAS101.5	10mm 3/8"		1.5m 60 in			
	ATDAS102.0			2m 80 in			
	ATDAS201.0			1m 40 in			
	ATDAS201.5	20mm 3/4"		1.5m 60 in			
	ATDAS202.0			2m 80 in			
 Hook Release Accessory Strap	ATDASH101.0		Hook Release	1m 40 in	Polypropylene webbing, anodised aluminium alloy buckles		
	ATDASH101.5	10mm 3/8"		1.5m 60 in			
	ATDASH102.0			2m 80 in			
	ATDASH201.0			1m 40 in			
	ATDASH201.5	20mm 3/4"		1.5m 60 in			
	ATDASH202.0			2m 80 in			



TIE-DOWN STRAPS

PRODUCT NAME	CODE	SIZE	WEIGHT	MATERIALS	COLOUR	RRP
 Bomber Tie-down (Single)	SOLBTD2	2m 6.5'	115g 4.1 oz	UV-stabilised polyester webbing, die-cast alloy buckle, silicone rubber protector		
	SOLBTD3	3m 10'	126g 4.4 oz			
	SOLBTD4	4m 13'	137g 4.8 oz			
 Tie-down with Silicone Cam Cover (Pair)	SOLDSCDP35	3.5m 11' 6"	500g 17.6 oz	UV-stabilised polyester webbing, die-cast alloy buckle, silicone rubber protector		
	SOLDSCDP45	4.5m 14' 6"	550g 19.4 oz			
	SOLDSCDP55	5.5m 18'	620g 21.9 oz			



FIELD REPAIR ACCESSORIES





Side Release - 1 Pin



Ladderlock - 1 Pin



Side Release - 2 Pin



Side Release - 2 Ladderlock

FIELD REPAIR BUCKLE

Our patented Field Repair Buckles provide an easy repair solution for broken or worn out buckles—no need to sew in a replacement buckle once your adventure's over.

FEATURES

- Strong, corrosion resistant stainless steel pins

SIZES 15mm / 20mm / 25mm / 38mm / 50mm



REFLECTIVE ACCESSORY CORD

Perfect to use as guy lines for tarps and tents, laundry line, a hang piece for your drink bottle lid or pocket knife. Made from hydrophobic polyester, the cord won't soak up water and stretch.

FEATURES

- Super bright reflective tracer
- Tight weave resists tangling

SIZES 10m (ø1.8mm) / 5m (ø3mm)





FIELD REPAIR BUCKLES

PRODUCT NAME	CODE	SIZE	MATERIALS	RRP
Ladderlock - 1 Pin	AFRB15LLP	15mm 5/8in	POM, stainless-steel pins	
	AFRB20LLP	20mm 3/4in		
	AFRB25LLP	25mm 1in		
Side Release - 1 Pin	AFRB15SRPA	15mm 5/8in	POM, stainless-steel pins	
	AFRB20SRPA	20mm 3/4in		
	AFRB25SRPA	25mm 1in		
	AFRB38SRPA	38mm 1 1/2in		
	AFRB50SRPA	50mm 2in		
Side Release - 2 Ladderlock	AFRB15SR	15mm 5/8in	POM, stainless-steel pins	
	AFRB20SR	20mm 3/4in		
	AFRB25SR	25mm 1in		
	AFRB38SR	38mm 1 1/2in		
	AFRB50SR	50mm 2in		
Side Release - 2 Pin	AFRB15SRPP	15mm 5/8in	POM, stainless-steel pins	
	AFRB20SRPP	20mm 3/4in		
	AFRB25SRPP	25mm 1in		
	AFRB38SRPP	38mm 1 1/2in		
	AFRB50SRPP	50mm 2in		

CORD

PRODUCT NAME	CODE	SIZE	DIMENSIONS	WEIGHT	MATERIALS	RRP
Reflective Accessory Cord	ARC10M	1.8mm	10m 33 ft	19g 0.7 oz	Polyester	
	ARC5M	3mm	5m 16.6 ft	26g 0.9 oz		



ROOF ACCESSORIES





PACK RACK

The impressively light and compact packed size makes the Pack Rack perfect for stowing in your bag and transporting boards, boats, skis and oversized gear when you're travelling and hiring cars. Conveniently stowed under your car seat, they are also great for unplanned purchases at the hardware store.

FEATURES

- Strong daisy chain provides multiple lash points for more secure fastening
- Multi-function Airstream Pumpsack for easy inflation, compact storage and a tail flag for oversize items
- Universal attachment fits a broad range of vehicles



Daisy chain lash



Compact pack size



Multi-function Pumpsack

420D WATERPROOF FABRIC

airstream™ PUMPSACK





TRAVELLER SOFT RACKS

An quick and easy system for transporting different sized watercraft or even a lumber purchase from the hardware store. The unique daisy chain design lets you change the position of your tie down to be as close as possible to the sides of whatever object you are carrying. This makes for a more secure load, with less chance of slipping.

FEATURES

- Wide footprint to disperse load on the roof
- Carries canoes, kayaks, sit-on-tops, surfboards, SUPs, skis, snowboards and other equipment

SIZES R / L



Grippy base reduces risk of movement





Super strong, removable daisy chain







INFLATABLE ROOF RACKS

PRODUCT NAME	CODE	SIZE	DIMENSIONS	PACKED DIMENSIONS	WEIGHT	MATERIALS	COLOUR	RRP
 Pack Rack	APAKRAK	Regular	77 x 14 x 10cm 30.3 x 5.5 x 3.9 in	ø12 x 25cm ø5.7 x 9.8 in	580g 22 oz	420D TPU-laminated Nylon, UV-stabilised polyester webbing, die-cast alloy buckle, silicone rubber protector		

FOAM ROOF RACKS

PRODUCT NAME	CODE	SIZE	DIMENSIONS	WEIGHT	MATERIALS	COLOUR	RRP
 Traveller Soft Racks	ATSR	Regular	86 x 19 x 8cm 34.7 x 7.5 x 2 in	1800g 63.5 oz	Nylon face fabric, closed-cell foam, UV-stabilised polyester webbing, die-cast alloy buckle, silicone rubber protector		
	SOLTSRL	Large	110 x 19 x 8cm 43.3 x 7.5 x 3.2 in	2460g 86.8 oz			

WATERSPORTS

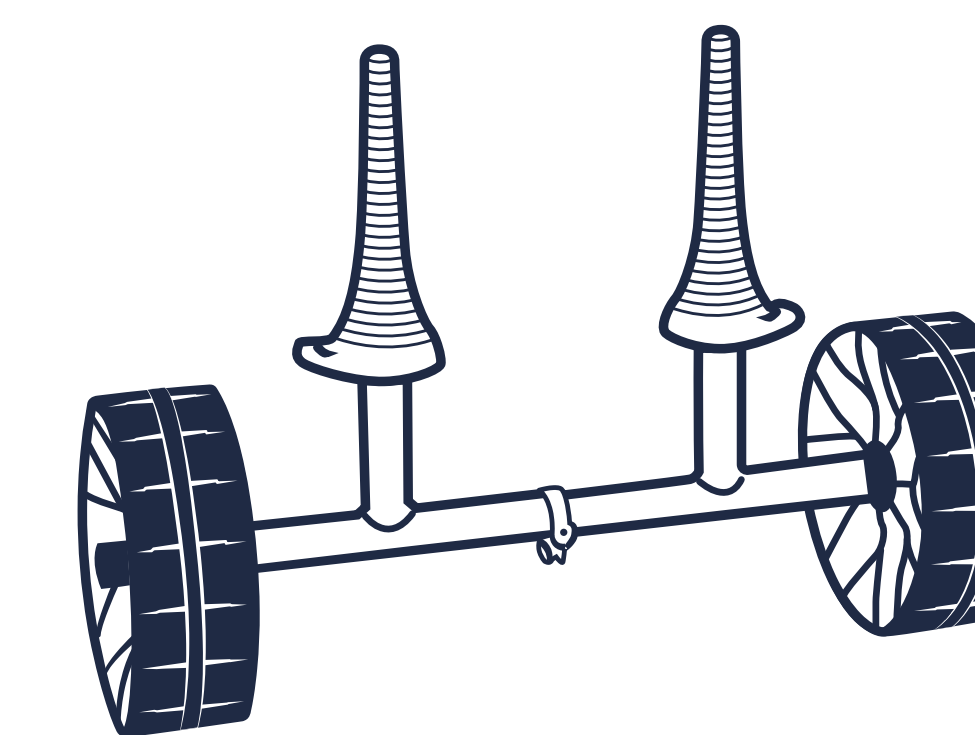

STORAGE + TRANSPORT

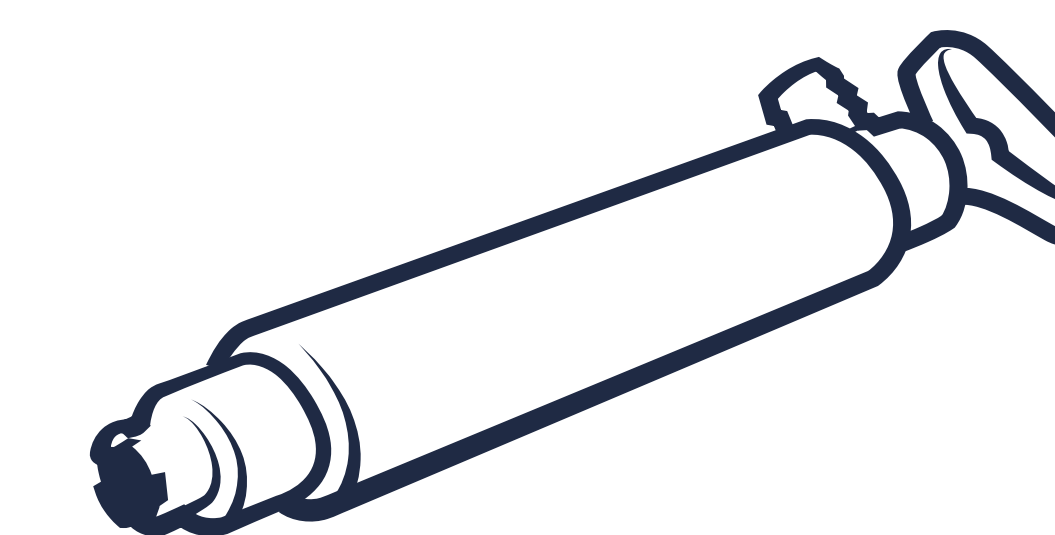

PADDLE ACCESSORIES



PERSONAL ACCESSORIES



STORAGE + TRANSPORT





EXPLORE THE RANGE

BOAT + BOARD TRANSPORT



CART FOR WATERCRAFT



SIT-ON-TOP CART

BOAT + BOARD STORAGE



AQUASLING



AQUARACKS



CART FOR WATERCRAFT - Solid Wheels

Our Solid Wheel Cart is the ideal choice for portages or transporting your kayak or canoe from the car to the water.

FEATURES

- Durable, lightweight and compact construction
- Built in tie-down with easy feed webbing

SIZES S / M

COLOURS  



Stainless steel pins



Oversized anodised 6063-t6 alloy tubing



Hypalon retainers for increased strength





SIT-ON-TOP CART - Solid Wheels

Our Solid Wheel Sit-on-Top Cart is a unique kayak cart that is universal in application and robust enough to cater to a large range of sit-on-top kayaks.

FEATURES

- Lightweight, innovative design

COLOURS

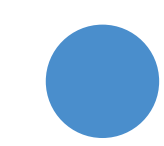

Adjustable axle width from 180-400mm

Tapered rubber cones to fit scuppers from 24-48mm

Puncture-proof solid wheels offer great soft terrain performance



AQUASLING

Sling your watercraft onto your wall with ease.

FEATURES

- Simple design allows a single person to easily access and store their craft
- Ideal for SUPs and surfboards
- Great for indoor and outdoor applications
- Easy to install—complete mounting hardware and instructions included



AQUARACKS

Aquaracks can accommodate virtually any paddle craft on the market and allow for storage at almost any angle without causing damage. They are a great way to store your boats in the garage, gear shed or favourite room at home.

FEATURES





- Specially designed padded arms prevent damage or depressions to the hull and finish
- Suitable for indoor or outdoor applications

SIZES S / R







COLOURS  



**BOAT + BOARD TRANSPORT**

PRODUCT NAME	CODE	SIZE	DIMENSIONS	WEIGHT	MATERIALS	COLOUR	RRP
 Cart - Solid Wheels	SOLCARTM	Medium	79 x 36 x 15cm 14 x 11 x 6 in	2.9 kg 6 lbs 5 oz	Anodised aluminium tubing, glass-reinforced polypropylene wheels, thermoplastic rubber wheel surfaces		
	SOLCARTS	Small	66 x 31 x 15cm 12 x 8 x 6 in	3.3 kg 7 lbs 5 oz			
 Sit-on-Top Cart - Solid Wheels	SOLSOTG				Anodised aluminium tubing, glass-reinforced polypropylene wheels, thermoplastic rubber wheel surfaces		

BOAT + BOARD STORAGE

PRODUCT NAME	CODE	SIZE	CAPACITY	DIMENSIONS	WEIGHT	MATERIALS	COLOUR	RRP
 Aquasling	SQSLINGBL			220 x 5.5 x 2cm 86.6 x 2.2 x 0.8 in	430g 22 oz	Reinforced Nylon straps, EVA foam, Nylon hook and 'D' Ring		
 Aquaracks SM (Pair)	SQRACKSGN	Small	50kg 110lbs	66 x 61 x 4cm 26 x 24 x 1.6 in	1840g 65 oz	Powder-coated steel tubing, closed-cell foam, Nylon outer surface		
 Aquaracks (Pair)	SQRACKYW	Regular	80kg 175lbs	84 x 45 x 4cm 33.1 x 17.7 x 1.6 in	2520g 89 oz			



PADDLE ACCESSORIES





EXPLORE THE RANGE

SAFETY GEAR



PADDLE KEEPER



BILGE PUMP



PADDLE LEASH



FOAM PADDLE FLOAT



INFLATABLE PADDLE FLOAT

SPRAY DECKS



FLEXI FIT SPRAY DECK

WATERPROOF DECK BAGS



ACCESS DECK BAG



SUP DECK BAG



PADDLE KEEPER

Our Paddle Keeper is the perfect solution for keeping your paddle attached to your kayak or canoe when resting, fishing or during the occasional swim. Can also be used as a fishing rod lanyard.

FEATURES

- Suits standard shaft diameter range of 28–32mm
- Double hook-and-loop paddle shaft attachment that doubles back for enhanced security



PADDLE LEASH

Lightweight paddle leash for both sea and kayak fishing.

FEATURES

- Stretchy inner cord for more flexibility
- Hook-and-loop closure on durable, non-slip strap for security



BILGE PUMP

A must have for any open water paddler, our Bilge Pump is a quick and effective way to empty water from your kayak or canoe.

FEATURES

- High-volume, double action pump extracts 400ml per pump
- Full-length high visibility foam with reflective logo aids recovery





FOAM PADDLE FLOAT

Foam paddle floats require no inflation making them faster and easier to deploy in the event of a capsize.

FEATURES

- Includes an attached, high visibility safety whistle
- Mesh paddle blade garage for water drainage



INFLATABLE PADDLE FLOAT

This single chamber inflatable paddle float can be used in conjunction with a paddle to stabilise a kayak in the event of a capsize, making re-entry easier.

FEATURES

- Easy access from deck during emergency - just pull the red tab





FLEXI FIT SPRAYSKIRT

The Flexi Fit Skirt is for anyone who wants a multi-fitting tunnel. Having a 2mm flexible neoprene waist will increase your torso comfort over a long paddle. Available in four cockpit sizes.

FEATURES

- Super soft binding for increased comfort
- 4mm small diamond neoprene skirt with a 2mm flexible neoprene waist for extra give
- 40mm wide pull-tag sewn in for easy opening

SIZES S / M / L / XL





ACCESS DECK BAG

Our Access Deck Bag offers easy access to essentials like a camera, sunscreen, and snacks without exiting your kayak. With two different systems, it's also super simple to attach without needing to add any cord or extra attachment points.

FEATURES

- Curved, water-resistant zip
- A 70D drybag is also secured internally to provide complete waterproofness for the internal contents.
- Two methods of securing to your kayak: hook-and-loop strips on the base, or side release buckles on the sides



SUP DECK BAG

While it was designed for Stand Up Paddleboards, there's also no reason to limit yourself to SUPs—this bag is equally useful on all manner of kayaks, boats, and rafts.

FEATURES

- Non-wicking roll-top closure
- Lash points can be secured to your craft with 3M brand self-adhesive.
- Strong durable loops for attaching gear externally





SAFETY GEAR

PRODUCT NAME	CODE	SIZE	DIMENSIONS	WEIGHT	MATERIALS	COLOUR	RRP
Paddle Leash	SOLPLEASH	110-190cm 43-75in		34g 1.2 oz	Nylon sheath, rubber bungee cord		
Paddle Keeper	SOLPKEEPER	110-240cm 43-95in			Nylon webbing		
Bilge Pump	SOLBILGE			340g 15 oz	ABS plastic cylinder, anodised aluminium alloy shaft		
Foam Paddle Float	SOLFPF		45 x 28 x 11cm 18 x 11 x 4 in	269g 10 oz	420D TPU-laminated Nylon, closed-cell foam		
Inflatable Paddle Float	SOLIPF		40 x 28 x 18cm 16 x 11 x 7 in	215g 8 oz	420D PU-coated Nylon		

SPRAY DECKS

PRODUCT NAME	CODE	SIZE	DIMENSIONS	WEIGHT	MATERIALS	COLOUR	RRP
	SOLFFSCS	S					
Flexi Fit Sprayskirt	SOLFFSCM	M			Neoprene		
	SOLFFSCL	L					
	SOLFFSCXL	XL					

DECK BAGS

PRODUCT NAME	CODE	SIZE	DIMENSIONS	WEIGHT	MATERIALS	COLOUR	RRP
Access Deck Bag	ARDKBBL		37 x 18 x 10cm 14.5 x 7 x 4 in	520g 19.5 oz	420D TPU-laminated Nylon, 70D PU-coated Nylon internal dry bag		
SUP Deck Bag	ASUPDB12	12L	36 x 28 x 15cm 14.2 x 11 x 5.9 in	340g 12 oz	420D TPU-laminated Nylon, aircraft-aluminium alloy buckles		



PERSONAL ACCESSORIES





ECLIPSE GLOVES

Grab your fingerless Eclipse Gloves for excellent UV protection when paddling.

FEATURES

- UPF50+ for protection against the sun
- 2mm neoprene cuff with hook-and-loop closure helps maintain flexibility in the wrist

SIZES See table



PADDLE GLOVES

Our neoprene Paddle Gloves protect your hands from the harsh elements, keeping them warm and reducing the risk of blisters.

FEATURES

- Great protection against the sun and blisters
- Grip pattern on palm

SIZES See table



ULTRA FLEX BOOTIES

Durable, low profile footwear for kayaking, stand up paddling, surfing, rafting, windboarding, kite boarding or sailing

FEATURES

- Flexible, sensitive sole gives great feedback for technical pursuits
- Secure Y-pull strap system

SIZES See table





GLOVES

PRODUCT NAME	CODE	SIZE	WEIGHT	RRP
Eclipse Gloves	SOLEGS	Small	34g 1.2 oz	
	SOLEGM	Medium	37g 1.3 oz	
	SOLEGL	Large	39g 1.4 oz	
	SOLEGXL	XL	42g 1.5 oz	
Paddle Gloves	SOLPGS	Small	142g 3.5 oz	
	SOLPGM	Medium	107g 3.8 oz	
	SOLPGL	Large	116g 4.1 oz	
	SOLPGXL	XL	125g 4.4 oz	

BOOTIES

PRODUCT NAME	CODE	SIZE	US MEN'S SIZE	RRP
Ultra Flex Booties	SOLFB05	XS	5	
	SOLFB06	S	6	
	SOLFB07	SM	7	
	SOLFB08	M	8	
	SOLFB09	ML	9	
	SOLFB10	L	10	
	SOLFB11	XL	11	
	SOLFB12	XXL	12	
	SOLFB13	XXXL	13	
	SOLFB14	XXXXL	14	



GLOSSARY

15D ULTRA-SIL™

Our proprietary ultralight 15D Ultra-Sil fabric has a siliconised outer surface that improves water repellency and prevents the fabric from absorbing water. It also has a Polyurethane (PU) inner face to create a water resistance of 1,200mm and allow seam-sealing.

70D WATERPROOF FABRIC

This is our lightweight high density weave waterproof fabric. It's a 70 denier 210T Nylon with a white interior polyurethane (PU) coating. The high density 210T weave gives the fabric a stronger tear strength and greater durability. The white PU coating reflects light and makes it easier to identify contents inside your dry sack. We vary the PU coating to make two different versions of this fabric: 2,000mm (Nylon Stuff Sacks, Pack Covers and Compression Sacks) and 10,000mm (Lightweight Dry Sacks, eVac Dry Sacks and Dry Compression Sacks) waterhead rated.

210D STOPPER FABRIC

Our Stopper fabric is made from 210 denier Nylon that is Thermoplastic Urethane (TPU) laminated on the outside. The hydrostatic waterhead test went off the scale on our Hydrostatic test machine. A departure from our usual internal TPU lamination, Stopper fabric has a stiffer feel than our Big River 420D fabric and a smooth water-shedding finish. The substantial TPU lamination allows us to construct dry bags with permanent welded seams that don't require any sewing or taping. Stopper fabric is ideal where there is a lot of abrasion coming from the inside

600D HYDRAULIC FABRIC

Our Hydraulic fabric is stiffer and tougher than our Stopper fabric and has a waterhead of 30,000mm+. It's constructed from a 300D x 600D Nylon with a heavy Thermoplastic Urethane (TPU) laminate exterior. The 600D X 300D is the best strength-to-weight fabric in this category and the heavy TPU laminate gives a tough, smooth, water-shedding exterior and allows us to weld Hydraulic Dry Bags—meaning no sewing or taping is required. This is our guide/expedition grade dry bag fabric.

30D ULTRA-SIL™

Our proprietary Ultra-Sil fabric employs CORDURA® high-tenacity Nylon yarn for increased strength and abrasion resistance. In our Ultra-Sil Dry Sacks, the 30D high-tenacity Nylon outer face is impregnated with silicone and a Polyurethane (PU) coating is applied on the inside. It has a water resistance of over 2,000mm. The silicone outer face sheds water exceptionally well and creates a slippery surface for easy packing. The PU coating on the inside improves the waterhead rating and allows for sealing of the seams.

ORIGIN RECYCLED FABRIC

Our Origin fabrics use recycled Nylon made from waste yarns, discards from weaving mills and fabric scraps from factories. All this material used to be sent to landfill but is now reclaimed and recycled into high quality Nylon fabric.

420D WATERPROOF FABRIC

Otherwise known as our Big River fabric, this is made using a super-durable ripstop Nylon with a white waterproof Thermoplastic Urethane (TPU) laminated to the inside. It's a 420 denier fabric with a waterhead in excess of 10,000mm+ (we exceeded the limits of our Hydrostatic test machine). This fabric has a high density weave and is extremely abrasion resistant.

CORDURA® FABRIC

CORDURA® brand yarn is a high-tenacity Nylon yarn that's stronger and more abrasion resistant than standard Nylon fibres of the same weight.



eVent® is a proprietary waterproof breathable membrane fabric with micro-fine pores that allow the passage of water vapour but not liquid. Traditionally, waterproof and breathable PTFE (polytetrafluoroethylene) membranes glog easily by body oils, which renders them useless after a little use. The solution was to add a PU backing to protect the PTFE membrane. When thin enough, PU still allows vapour transmission but at a much lower rate. Some manufacturers avoid the membrane and just use a PU coating. The PU has to be relatively thick to ensure sufficient waterproofing, resulting in even lower breathability. The genius of eVent® was to make the membrane oleophobic (oil repellent), meaning it wouldn't clog with oils, therefore didn't need the inhibiting PU layer. At 20,000mm, eVent® is the most breathable waterproof fabric we know of. It is sufficiently breathable that a pressure gradient can force air through it. We use eVent in this way as a purge valve in the bottom of our eVac Dry Sacks, and our Ultra-Sil and 70D Dry Compression Sacks.



Thermoplastic Urethane (TPU) is a PVC-free material used as a waterproof barrier in our Accessory Guide Cases and Map Cases and in several models of our Dry Sacks. In its film format, its superior flexibility (even in cold weather) and waterproofness are key. It's also used as a transparent window in our View Dry Sacks and First Aid Dry Sacks.



Our DRY+ fabric is a remarkably fast-drying, recycled polyester blend with exceptional absorption. The fine yarn creates a greater surface area that holds three to six times its own weight in water—and dries faster than traditional cotton towels.



Ultra-Mesh is a 15 denier multi-filament Nylon mesh with 310 holes/cm² (2000 holes/inch²). Stronger than polyester yet ultralight, the multi-filament construction is soft and supple and dyed black for greater visibility of contents.



Made from a very durable 150 denier Polyester with 80 hexagonal holes per cm², it's dyed black for greater visibility of contents.



Ultra-Vis is a 15 denier, Nylon mesh with 80 hexagonal holes per cm² (500 holes/inch²). It is lighter and more compact than Ultra-Mesh. The mesh density allows great visibilty and airflow.



THERMOLITE® insulation provides lightweight warmth for all activites. We use THERMOLITE® insulation in many of our sleep system products in different forms. Sleeping bag liners use THERMOLITE® fibre knitted to create our Reactor THERMOLITE® fabric. Sleeping bags use THERMOLITE® insulation that is designed for superior warmth and exceptional softness. Our insulated Air Sprung Cell sleeping mats use THERMOLITE® insulation that is designed with high loft for excellent lightweight warmth with superior durability. The THERMOLITE® insulation lofts up inside the Air Sprung Cells to prevent convective heat loss from your warm body to the cold ground. THERMOLITE® is a trademark of the LYCRA Co.



Adaptor COOLMAX® is our most versatile liner fabric, it transports moisture away from the body to keep the wearer cool and dry in hot, humid environments for a more comfortable nights sleep and can adapt to add warmth when used as a layer in a sleeping bag. The COOLMAX® fibre is knitted into a 80g/m² fabric that is extremely breathable and extremely stretchy, which is great for the restless sleeper. COOLMAX® is a polyester fibre with a channeled cross section that wicks moisure away from the body and dries quickly. Machine washable and quick drying. COOLMAX® is a trademark of the LYCRA Co.

